

NEW GENERATION E.C. FANS



MOTORS
BRUSHLESS
INDUSTRIAL E.C.



HIGHLY
EFFICIENT IE3
MOTORS

EFFICIENT WORK FANS



EFFICIENT
WORK





OUR COMMITMENT TO THE ENVIRONMENT

Sodeca has begun a new stage of study and design of new trends in ventilation which will help to preserve the environment and to make the energy saving which so much concerns today's society.



EFFICIENT WORK

SODECA presents the new **high performance "Efficient Work" fans**, which are equipped with high-tech motors for greater energy savings. These new products exceed the requirements of the ErP Ecodesign Directive 2009/125/EC and Regulation (EU) 327/2011 for fans, in line with the KYOTO target adopted by the EU for reducing CO² emissions.

SODECA has concentrated its activity on the production of industrial fans, ventilation systems and extractors for the removal of smoke in case of fire since 1983, when it was founded.

SODECA's fans and extractors are present in all European countries and in many parts of the world, thanks to the quality of the product and the methods of research and development used.

Our quality procedures used and certified by BUREAU VERITAS, in accordance with ISO 9001:2008, are another of the reasons which make **SODECA** one of the best and most renowned fan manufacturers in Europe.

Without a doubt, the most important factor to achieve our objectives is the human factor, the great professionals who work at your service, offering not only ventilation equipment but also solutions to any ventilation need required by our customers.

We sincerely offer you the possibility of visiting our facilities in Sant Quirze de Besora, with over 16,000 square metres of built area, where you will be able to see our fan manufacture with perfect clarity and with the highest standards of quality, complying with the ISO and AMCA standards.

This catalogue is only a small part of our possibilities. Do not hesitate to contact us. We will put all our experience and our human resources at your disposal.



Installations headquarters of SODECA s.a., at Sant Quirze de Besora and manufacturing plant in Santiago de Chile.



SODECA presents the new high performance “**Efficient Work**” fans, which are equipped with high-tech motors for greater energy savings. These new products exceed the requirements of the ErP Ecodesign Directive 2009/125/EC and Regulation (EU) 327/2011 for fans, in line with the KYOTO target adopted by the EU for reducing CO2 emissions.

SOLUTIONS



A permanent magnet synchronous **Industrial Brushless EC** motor, which is up to 27% more efficient than an equivalent asynchronous motor, also has an electronic variable speed drive (VSD) as standard.



High performance IE3-compliant asynchronous three-phase motors, optionally equipped with electronic variable speed drive (VSD), exceed the efficiency requirements of Regulation 2009/640/EC on electric motors.



Electronic variable speed drives (VSD) regulate fan speed to suit demand, thus providing additional energy savings. SODECA has a wide range of electronic control accessories to be used jointly with the variable speed drive. Your installation's temperature, humidity, CO2 and pressure can be controlled by adjusting fan speed to suit demand. In addition, electronic variable speed drives (VSD), can be connected in single-phase or three-phase networks operating at a wide range of supply voltages and frequencies.

ENERGY SAVINGS COMPARISON

Just replacing the fan installed by one with EC technology can reduce power consumption by 21%. Installing an electronic control that regulates the electronic variable speed drive (VSD) will provide a demand controlled ventilation (DCV) system, which will result in much higher savings.

The case below simulates the demand for ventilation on a workday (7:00 AM - 9:00 PM) in an office building, in accordance with the technical report "Demand Controlled Ventilation Systems" Annex 18, by the International Energy Agency (IEA).

The energy savings obtained in the above case by replacing the conventional ventilation system by one with EC technology with demand controlled ventilation - an average reduction of 50% - are shown below.

Energy savings quickly compensate for the extra cost of the EC equipment. Being an economical option, with or without a ventilation controlled system demand.

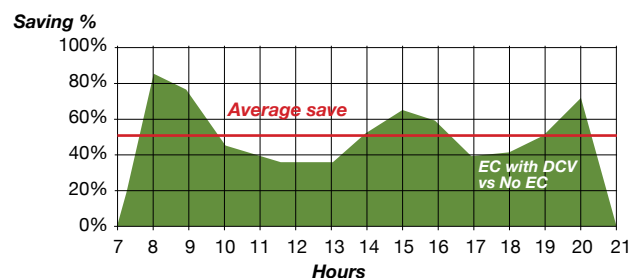
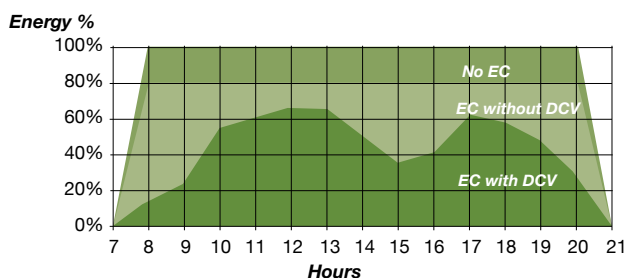

EFFICIENT WORK FANS



SOLution DEVELOPMENT CAPACITY

Fast and flexible industrial fan solutions and tailored fans

Extensive experience with smoke control systems and ATEX applications

Wide range of certified products for specific markets

CENTRIFUGAL AND ROOF FANS



CENTRIFUGAL FANS AND IN-LINE EXTRACTORS



FANS FOR SMOKE EXTRACTION



ATEX FANS FOR EXPLOSIVE ATMOSPHERES AND OTHER APPLICATIONS



HEAT RECOVERY SYSTEMS AND FILTRATION UNITS



AIR CURTAINS FOR COMMERCIAL AND INDUSTRIAL APPLICATIONS



VENTILATION SYSTEMS FOR HOUSES



Ask us for information



Crta. de Berga, km 0,7
 E-08580 St. Quirze de Besora
 BARCELONA (Spain)
 Tel. +34 93 852 91 11
 Fax. +34 93 852 90 42

comercial@sodeca.com
 Export sales: ventilation@sodeca.com
 www.sodeca.com



FULFILMENT OF STANDARDS

SODECA's fans and extractors comply with the following standards:

QUALITY	
ISO 9001:2008	Sistemas de gestión de la calidad. Requisitos. Quality management systems -- Requirements
TESTS	
ISO 5801	Ventiladores industriales. Industrial fans -- Performance testing using standardized airways Industrial fans -- Performance testing using standardized airways
AMCA 210-99	Ventiladores industriales. Métodos de ensayos de ventiladores y su representación de ensayos. Laboratory Methods of Testing Fans for Aerodynamic Performance Rating
UNE 100212:1990	Ventiladores. Dispositivos e instalaciones para el ensayo de ventiladores.
ISO 13350	Ventiladores industriales. Ensayos de comportamiento de ventiladores de chorro. Industrial fans -- Performance testing of jet fans
ISO 13348	Industrial fans -- Tolerances, methods of conversion and technical data presentation
FANS FOR HIGH TEMPERATURES	
EN 12101-3:2002	Sistemas de control de humos y calor. Parte 3: Especificaciones para aireadores extractores de humos y calor mecánicos. Smoke and heat control systems - Part 3: Specification for powered smoke and heat exhaust ventilators
ACOUSTICS	
ISO 3744	Acústica. Determinación de los niveles de potencia acústica de fuentes de ruido a partir de la presión acústica. Método de ingeniería para condiciones de campo libre sobre un plano reflectante. Acoustics -- Determination of sound power levels of noise sources using sound pressure -- Engineering method in an essentially free field over a reflecting plane
BALANCE AND VIBRATIONS	
ISO 1940-1	Vibraciones mecánicas. Calidad de equilibrado Mechanical vibration -- Balance quality requirements for rotors in a constant (rigid) state -- Part 1: Specification and verification of balance tolerances
ISO 10816-1	Vibraciones mecánicas. Evaluación de las vibraciones de máquinas Mechanical vibration -- Evaluation of machine vibration by measurements on non-rotating parts -- Part 1: General guidelines
ISO 14694	Ventiladores industriales. Especificaciones para equilibrado y niveles de vibración Industrial fans -- Specifications for balance quality and vibration levels
SAFETY (Declaration of EC Compliance)	
EN ISO 12100-1	Seguridad de las máquinas. Conceptos básicos, principios generales para el diseño. Parte 1: Terminología básica, metodología. Safety of machinery -- Basic concepts, general principles for design -- Part 1: Basic terminology, methodology
EN ISO 12100-2	Seguridad de las máquinas. Conceptos básicos, principios generales para el diseño. Parte 2: Principios técnicos. Safety of machinery -- Basic concepts, general principles for design -- Part 2: Technical principles
EN 60204-1	Seguridad de las máquinas. Equipo eléctrico de las máquinas. Parte 1: Requisitos generales. Safety of machinery - Electrical equipment of machines - Part 1: General requirements
ISO 13857	Seguridad de máquinas. Distancias de seguridad para impedir que se alcancen zonas peligrosas con los miembros superiores e inferiores. Safety of machinery -- Safety distances to prevent danger zones being reached by upper and lower limbs
UNE 100250	Ventiladores industriales. Seguridad mecánica de los ventiladores (equivalente ISO 12499)
ISO 12499	Ventiladores industriales. Seguridad mecánica en los ventiladores Industrial fans -- Mechanical safety of fans -- Guarding
DIRECTIVES	
Directiva 2006/42/CE	Directiva de máquinas Machinery Directive
Directiva 2006/95/CE	Directiva de baja tensión Low Voltage Directive
Directiva 2004/108/CE	Directiva compatibilidad electromagnética EMC Directive
Directiva 89/106/CE	Directiva productos de construcción Construction Products Directive (CPD)
Directiva 2009/125/CE	Directiva de requisitos de diseño ecológico para productos que utilizan energía. Ecodesign Requirements for Energy-related Products Directive
ATEX EXECUTIONS	
Directiva ATEX 94/9/CE	Aparatos y sistemas de protección para uso en atmósferas potencialmente explosivas Equipment and protective systems intended for use in potentially explosive atmospheres
EN 14986	Diseño de ventiladores para trabajar en atmósferas potencialmente explosivas. Design of fans working in potentially explosive atmospheres
EN 13463-1	Equipos no eléctricos destinados a atmósferas potencialmente explosivas. Parte 1: Requisitos y metodología básica. Non-electrical equipment for use in potentially explosive atmospheres - Part 1: Basic method and requirements
EN 1127-1	Atmósferas explosivas. Prevención y protección contra la explosión. Parte 1: Conceptos básicos y metodología. Explosive atmospheres - Explosion prevention and protection - Part 1: Basic concepts and methodology



EFFICIENT WORK



EFFICIENT WORK FANS

IN-LINE DUCT FANS

SV/ECO



11

BRUSHLESS

NEOLINEO/EW



13

BRUSHLESS

AXIAL FANS

HEP/EW



15

BRUSHLESS

HEPT/EW



17

BRUSHLESS

HC/EW



22

AC IE3

**HCH/EW
HCT/EW HFT/EW**



26

AC IE3

CENTRIFUGAL FANS

**CBD/EW
CBD/B/EW**



34

BRUSHLESS

**CJBD/EW
CJBD/EW/AL**



36

BRUSHLESS

CJEC/EW



83

BRUSHLESS

CMA/EW



41

BRUSHLESS

CMP-L/EW



45

BRUSHLESS

CMP/EW



50

AC IE3

CMR-L/EW



57

BRUSHLESS

CMR/EW



60

AC IE3

CAS-L/EW



66

BRUSHLESS

CAS/EW



70

AC IE3

EFFICIENT WORK FANS

FANS FOR SMOKE EXTRACTION F-400



TCR/R/EW
CJTCR/R/EW

76

CJLINE/EW

80

CJEC/EW

83

CHT/EW
CVT/EW

86

ROOF FANS

HT-L/EW

90

HT/EW

93

CHT/EW
CVT/EW

86

OVERPRESSURE KIT

OVERPRESSURE KIT

96









EFFICIENT WORK



Example of configuration control

E.C. BRUSHLESS MOTOR BRUSHLESS INDUSTRIAL E.C.

Setting	Sensor	Control
MANUAL (Optional with order code D)		 Manual control MTP010
TEMPERATURE (Optional with order code D)		 Control SI-TEMP+ HUMEDAD
HUMIDITY TEMPERATURE (Optional with order code D)	 Probe humidity SI-HUMEDAD	 Control SI-TEMP+ HUMEDAD
CO2 (Optional with order code D)		 CO2 Control SI-CO2-GAQ24 24V ac
PRESSURE (Included with order code P)		 Pressure transmitter SI-PRESIÓN
Full control pressure kit (Included with order code K)		 BOXPRES KIT/B









VARIABLE SPEED DRIVE
VSD: Variable Speed Drive.
· VSD1/B
· VSD3/B

Supply included with fan

SUPPLY
VSD1/B:
220-240 V 50/60 Hz
VSD3/B:
380-415 V 50/60 Hz

INCLUDES:
VSD1/B or VSD3/B variable speed drive
Differential pressure probe
Magneto thermal
Line LED and fault
Check button

AC IE3 HIGHLY EFFICIENT IE3-COMPLIANT THREE-PHASE MOTORS

Setting	Sensor	Control
MANUAL (Optional with order code D)		 Manual control MTP010
TEMPERATURE (Optional with order code D)		 Control SI-TEMP+ HUMEDAD
HUMIDITY TEMPERATURE (Optional with order code D)	 Probe humidity SI-HUMEDAD	 Control SI-TEMP+ HUMEDAD
CO2 (Optional with order code D)		 CO2 Control SI-CO2-GAQ24 24V ac
PRESSURE (Included with order code P)		 Pressure transmitter SI-PRESIÓN
Full control pressure kit (Included with order code K)		 BOXPRES KIT



VARIABLE SPEED DRIVE
VSD: Variable Speed Drive.
· VSD1/A-RFM
· VSD3/A-RFT







SUPPLY
VSD1/A-RFM:
220-240 V 50/60 Hz
VSD3/A-RFT:
380-415 V 50/60 Hz

INCLUDES:
VSD1/A-RFM or VSD3/A-RFT
Variable Speed Drive
Differential pressure probe
Magneto thermal
Line LED and fault
Check button



Example of configuration control



Setting	Sensor	Control
MANUAL		 Manual control MTP010
TEMPERATURE		 Control SI-TEMP+ HUMEDAD
HUMIDITY TEMPERATURE	 Probe humidity SI-HUMEDAD	 Control SI-TEMP+ HUMEDAD
CO2		 CO2 Control SI-CO2-GAQ24 24V ac
PRESSURE		 Pressure control SI-CONTROL PRESIÓN





EXAMPLE EW CURVES

Fan features at maximum speed

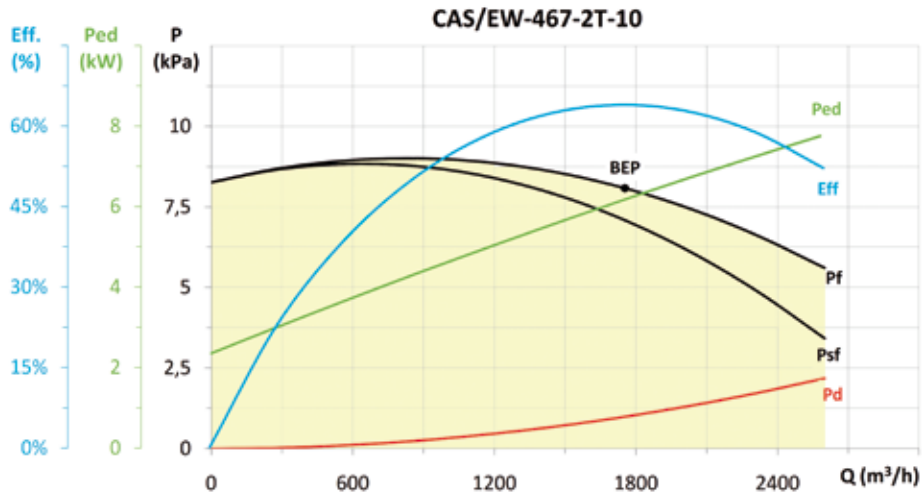

MC	EC	SR	Cc	η_e (%)*	N	[kW]	[m³/h]	[Pa]	[rpm]	VSD
B	T	1,08	1,04	66,5%	68,7	6,152	1754	8078,7	2954	NECESSARY

* η_e (%) = Eff. (%) x Cc

Name	Description	Units
Eff	Static or total efficiency according to efficiency category (EC)	%
Ped	Input electric power to the VSD	W or kW
Psf	Static fan pressure	Pa or kPa
Pf	Total fan pressure	Pa or kPa
Pd	Dynamic fan pressure	Pa or kPa
Q	Airflow	m³/h

By adjusting the fan speed it would be possible to obtain a large working area under the flow-pressure curve at maximum speed

MC	Measurement category
EC	Efficiency category
	S Static
	T Total
SR	Specific ratio
Cc	Compensation coefficients partial load is applied using VSD
η_e [%]	ErP global efficiency, if VSD is used must be multiplied by Cc (η_e (%) = Eff (%) x Cc)
N	Efficiency grade
[kW]	Electric power
[m³/h]	Airflow
[Pa]	Static or total pressure (According to EC)
[RPM]	Speed
VSD	Variable speed drive
	NECESSARY The fan should be installed with VSD
	INCLUDED The VSD is supplied with fan
	INTEGRATED The VSD is integrated into the fan motor



SV/ECO

**MOTOR
BRUSHLESS WITH
INTEGRATED VSD**

Low noise in-line duct fans mounted in acoustic casing with 50 mm insulation, fitted with EC motor



CONTROL
Supply optional
accessory

Fan:

- Acoustic casing covered with sound absorbing material.
- Backward-curved impeller for all models.
- Standard aspiration and impulsion joints to aid in duct installation.
- They are supplied with 4 base stands to aid installation.
- Linear air circulation.

Motor:

- Single-phase 230 V. 50/60 Hz.
- Max. air temperature to transport: + 50 °C.
- Highly-efficient brushless-EC motor, electronically controlled by means of a potentiometer of 10 kΩ MTP010, or an external signal of 0-10 V.

Finish:

- Anticorrosive finish in polyester resin polymerised at 190°C, after alkaline degreasing with nanotechnology treatment and phosphate-free.

Order code

SV/ECO — 150/H

SV/ECO: In-line fans for ducts with EC motor and integrated variable speed drive

Inlet diameter in mm

Technical characteristics

Model	Speed (r/min)	Maximum admissible current (A)	Installed power (kW)	Maximum airflow (m ³ /h)	Sound pressure level to 50% of maximum speed * dB(A)	Weight approx. (Kg)
SV/ECO-125/H	4480	0.46	0.055	367	29	12
SV/ECO-160/H	3490	0.99	0.114	565	28	19
SV/ECO-200/H	3380	1.48	0.192	914	39	24
SV/ECO-250/H	3220	1.69	0.213	1107	32	24
SV/ECO-315/H	3580	2.8	0.448	1638	49	31

* Sound pressure level dB(A) are measurements at a distance of 1.5 meters.

Acoustic features at maximum speed

The specified values are determined according to free field measurements of sound levels in dB(A) at an equivalent distance of twice the fan's span plus the impeller's diameter, with a minimum of 1.5 m.

Sound power Lw(A) spectrum in dB(A) via frequency band in Hz.

Model	63	125	250	500	1000	2000	4000	8000	Model	63	125	250	500	1000	2000	4000	8000
SV/ECO-125/H	31	41	54	56	45	45	40	44	SV/ECO-250/H	48	57	70	64	66	59	53	52
SV/ECO-160/H	39	49	63	60	49	51	48	46	SV/ECO-315/H	50	59	73	67	68	65	58	55
SV/ECO-200/H	42	52	66	60	56	54	51	52									

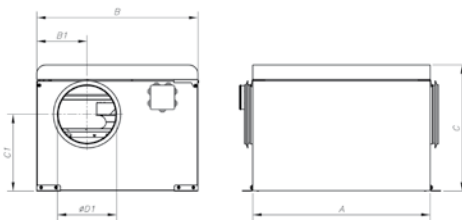
Dimensions in mm

Model	A	B	B1	C	C1	øD1	øD2	E	F
SV/ECO-125	400	410	205	325	165.5	125	12.5	330	440
SV/ECO-160	550	485	149	340	194.5	160	12.5	405	590
SV/ECO-200	600	545	170	425	259.5	200	12.5	465	640
SV/ECO-250	600	545	194	425	234.5	250	12.5	465	640
SV/ECO-315	675	595	227.5	475	251.5	315	12.5	515	715



EFFICIENT WORK



Erp. Characteristic curves and ErP data

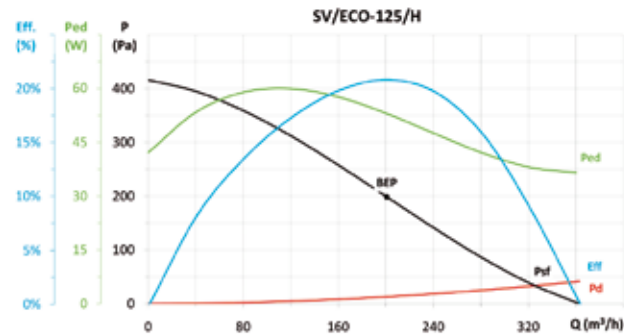

MC	EC	SR	Cc	η_e (%)*	N	[kW]	[m³/h]	[Pa]	[rpm]	VSD
A	S	-	-	-	-	0,053	201	198	4480	INTEGRATED

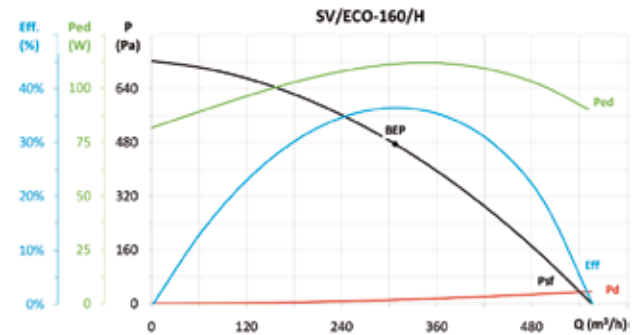

MC	EC	SR	Cc	η_e (%)*	N	[kW]	[m³/h]	[Pa]	[rpm]	VSD
A	S	-	-	-	-	0,111	308	474	3490	INTEGRATED

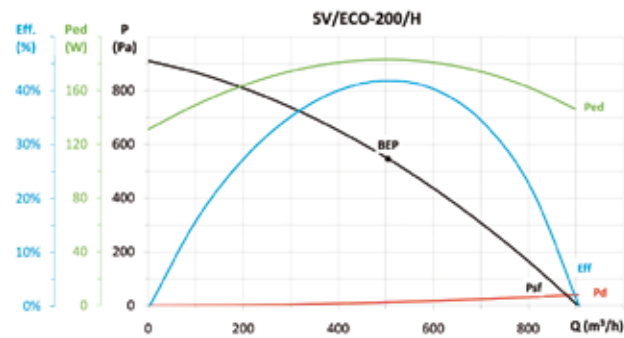

MC	EC	SR	Cc	η_e (%)*	N	[kW]	[m³/h]	[Pa]	[rpm]	VSD
A	S	1,01	1,14	47,7%	65,9	0,183	505	546	3380	INTEGRATED

* η_e (%) = Eff. (%) x Cc

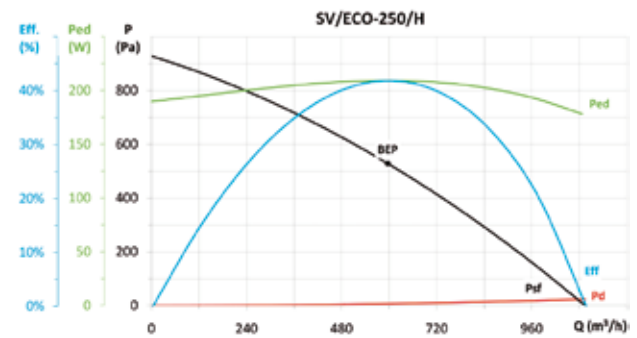

MC	EC	SR	Cc	η_e (%)*	N	[kW]	[m³/h]	[Pa]	[rpm]	VSD
A	S	1,01	1,13	47,5%	65,1	0,209	597	528	3220	INTEGRATED

* η_e (%) = Eff. (%) x Cc

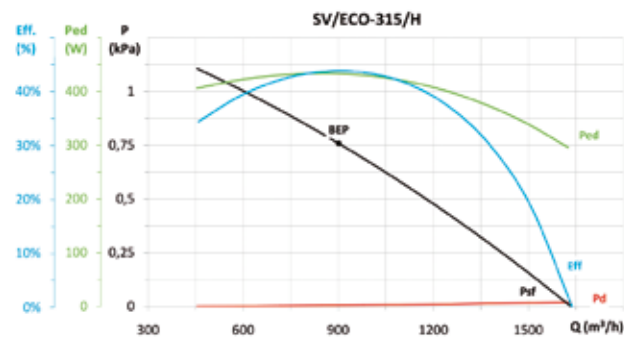

MC	EC	SR	Cc	η_e (%)*	N	[kW]	[m³/h]	[Pa]	[rpm]	VSD
A	S	1,01	1,11	48,8%	63,1	0,433	901	759	3580	INTEGRATED

* η_e (%) = Eff. (%) x Cc

Accessories

See accessories section.



Input and output kits



Rectangular grilles



Protection grilles



Circular grilles



Electric batteries



Butterfly valves



Outlet



Capture openings



Inlet/Outlet



Backdraught shutters



Accessories



Air filter boxes



CONTROL UNITS AND SENSORS



Air intakes for houses



Output openings for houses



Silencer

NEOLINEO/EW

**MOTOR
BRUSHLESS WITH
INTEGRATED VSD**

Low noise in-line duct fans with removable covers and small size fitted with Brushless/EC motors

Fan:

- V0 flame-retardant plastic casing.
- External terminal board, with variable position.
- Quick and easy to install.

Motor:

- Brushless/EC motors with with Long Life ball bearings
- IP44 protection.
- Two speeds can be selected using switch.
- Each speed can be regulated by a potentiometer in the terminal board. Model 315 adjustable external 0-10 V signal.
- Single-phase 220-240 V. 50 Hz

Working temperature:

- Models 100, 125 and 150: -10 °C +60 °C.
- Models 200, 250 and 315: -10 °C +50 °C.

Finish:

- Made from white, V0 flame-retardant plastic.

CONTROL
Supply optional accessory

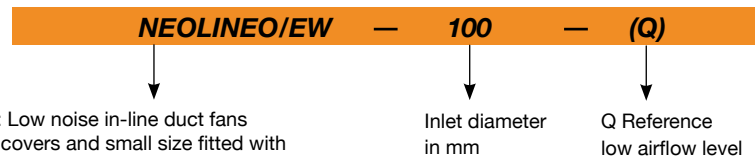
Order code

Technical characteristics

Model	Speed regulation	Speed (r/min) min/max	Current (A) min/max	Power (W) min/max	Maximum airflow (m ³ /h) min/max	Sound pressure level Lp dB(A)* min/max	Weight approx. (Kg)
NEOLINEO/EW-100-Q	Min. Speed.	1420/2120	0.05/0.08	4.5/7	90/145	21.0/33.3	1.5
	Nom. Speed	2125/2850	0.07/0.12	7/12	155/210	28.9/40.0	1.5
	Max. Speed.	2560/3300	0.10/0.16	10/16.5	170/230	33.5/44.5	1.5
NEOLINEO/EW-100	Vel. Min.	1320/1650	0.06/0.09	5.5/8	140/185	25.3/31.4	1.9
	Speed Nom.	1620/2000	0.09/0.12	8/12	180/255	31.4/36.4	1.9
	Speed Max.	1920/2330	0.11/0.17	11/17	220/270	35.7/40.8	1.9
NEOLINEO/EW-125	Speed Min.	1285/1660	0.07/0.11	6.5/10.5	190/270	28.9/35.1	1.8
	Speed Nom.	1600/2040	0.10/0.17	10/17	250/365	34.8/40.3	1.8
	Speed Max.	1870/2370	0.13/0.22	13.5/24	300/380	39.3/44.4	1.8
NEOLINEO/EW-150	Speed Min.	1340/1895	0.10/0.20	10/22	325/440	35.0/44.1	2.2
	Speed Nom.	1630/2230	0.15/0.31	15/35	385/550	41.6/47.1	2.2
	Speed Max.	1870/2560	0.20/0.44	22/52	465/620	46.0/53.2	2.2
NEOLINEO/EW-160	Speed Min.	1300/1900	0.10/0.21	10/23	325/450	33.8/44.6	2.1
	Speed Nom.	1560/2290	0.15/0.33	15/38	385/570	39.2/47.7	2.1
	Speed Max.	1830/2620	0.20/0.45	22/55	465/630	45.7/54.1	2.1
NEOLINEO/EW-200	Speed Min.	1990/2330	0.21/0.32	22/34	620/760	39.4/44.3	2.5
	Speed Nom.	2400/2820	0.33/0.50	36/57	750/1000	44.8/46.2	2.5
	Speed Max.	2750/3120	0.47/0.63	53/74	870/1080	45.3/47.5	2.5
NEOLINEO/EW-250	Speed Min.	1720/2280	0.26/0.54	27/59	650/850	43.0/50.9	5.3
	Speed Nom.	2100/2750	0.42/0.83	45/95	800/1150	47.4/55.0	5.3
	Speed Max.	2400/3010	0.59/1.06	65/124	920/1250	50.4/57.3	5.3
NEOLINEO/EW-315		1800/2350	0.83/1.60	119/240	1400/1900	53.2/60.7	9.5

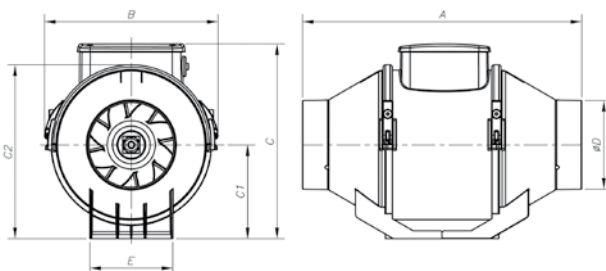
* The radiated sound pressure levels are free field measurements at 3 metres with rigid tubes during inlet and outlet.

Dimensions in mm

Model	A	B	C	C1	C2	øD	E
NEOLINEO/EW-100-Q	231	156	205	82	152	96	95
NEOLINEO/EW-100	303	188.5	240	101.5	189	96	90
NEOLINEO/EW-125	258	188.5	240	101.5	189	122	90
NEOLINEO/EW-150	294	214.5	265	112.5	212	146	110
NEOLINEO/EW-160	272.5	214.5	265	112.5	212	156	110
NEOLINEO/EW-200	300	234.5	290	125.5	235	196	140
NEOLINEO/EW-250	385	300	350	152.5	292	247	176.5
NEOLINEO/EW-315	448	361.5	460	188.5	359	312	220.5



EFFICIENT WORK



Erp. Characteristic curves and ErP data

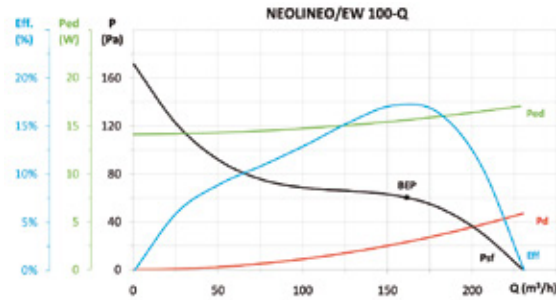

MC	EC	SR	Cc	η_e (%)*	N	[kW]	[m³/h]	[Pa]	[rpm]	VSD
A	S	-	-	-	-	0,016	161	60	3300	INTEGRATED

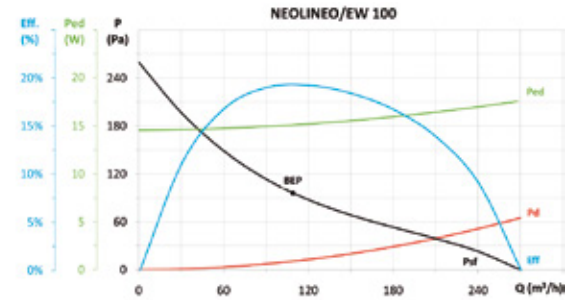

MC	EC	SR	Cc	η_e (%)*	N	[kW]	[m³/h]	[Pa]	[rpm]	VSD
A	S	-	-	-	-	0,015	109	96	2330	INTEGRATED

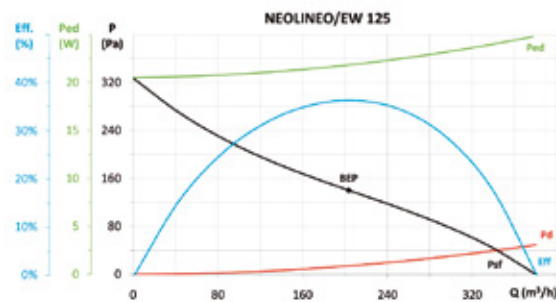

MC	EC	SR	Cc	η_e (%)*	N	[kW]	[m³/h]	[Pa]	[rpm]	VSD
A	S	-	-	-	-	0,022	203	140	2370	INTEGRATED

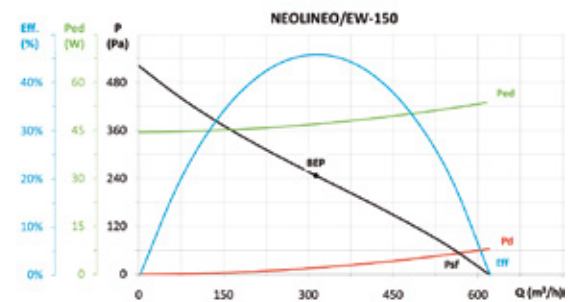

MC	EC	SR	Cc	η_e (%)*	N	[kW]	[m³/h]	[Pa]	[rpm]	VSD
A	S	-	-	-	-	0,047	313	247	2560	INTEGRATED

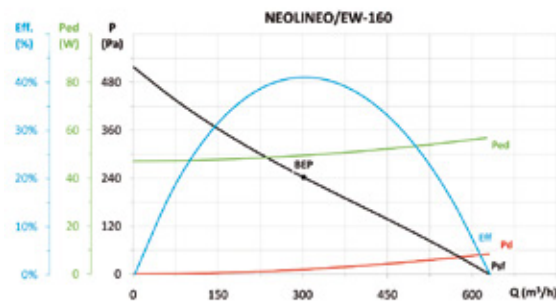

MC	EC	SR	Cc	η_e (%)*	N	[kW]	[m³/h]	[Pa]	[rpm]	VSD
A	S	-	-	-	-	0,049	301	242	2620	INTEGRATED

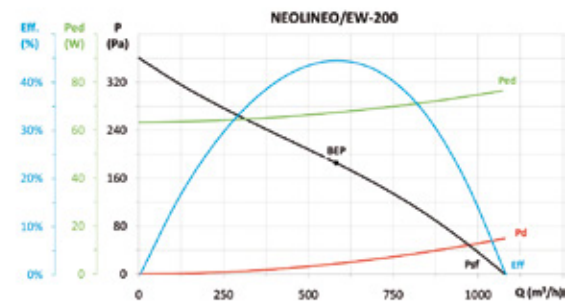

MC	EC	SR	Cc	η_e (%)*	N	[kW]	[m³/h]	[Pa]	[rpm]	VSD
A	S	-	-	-	-	0,067	582	185	3120	INTEGRATED

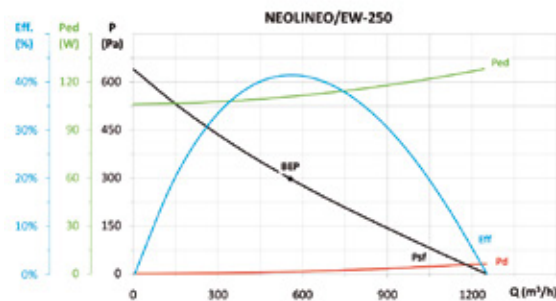

MC	EC	SR	Cc	η_e (%)*	N	[kW]	[m³/h]	[Pa]	[rpm]	VSD
A	S	-	-	-	-	0,111	556	297	3010	INTEGRATED

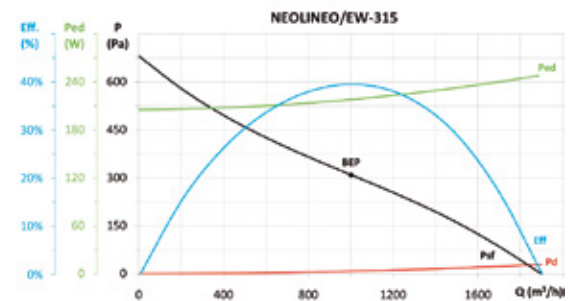

MC	EC	SR	Cc	η_e (%)*	N	[kW]	[m³/h]	[Pa]	[rpm]	VSD
A	S	1,00	1,13	44,8%	62,3	0,218	800	309	2350	INTEGRATED

* η_e (%) = ErP (%) × Cc

Accessories

See accessories section.



Standard installation kit (tube)

Standard installation plate

Parallel installation kit (flanges and rails)

One-way hatches

Fixed grilles

MTP010

Air filter boxes

Electric batteries

DUO two speed switch

CONTROL UNITS AND SENSORS

Air intakes for houses

Output openings for houses

Silencer

HEP/EW



VARIABLE SPEED DRIVE
VSD: Variable Speed Drive.
• VSD1/B
• VSD3/B

Supply included with fan

CONTROL
Supply optional accessory

SUPPLY
VSD1/B:
220-240 V 50/60 Hz
VSD3/B:
380-415 V 50/60 Hz

High-efficiency wall-mounted axial fans fitted with industrial BRUSHLESS motor E.C.

Fibreglass-reinforced plastic impeller.

Fan:

- Airflow direction from motor to impeller.
- Impeller in polyamide 6 reinforced with fibreglass.
- Sheet steel base plate.
- Protection guard to prevent contacts according to standard UNE 100250
- Electronic variable speed (VSD), three-phase or single-phase, is supplied with fan.

Motor and electronic variable speed:

- High-efficiency Industrial Brushless Motors E.C. Fitted with electronic variable speed (VSD), adjustable via external control input 0-10V.
- It is advisable to install an electronic variable speed drive (VSD) outside the working area.
- The external signal can be supplied through a manual or automatic control with 0-10 V output.
- Electronic variable speed drive (VSD), available with single-phase 220-240 V 50/60 Hz input (VSD1/B type) or three-phase 380-415 V 50/60 Hz (VSD3/B type).
- By default, the electronic variable speed drive (VSD) is delivered programmed for constant speed.

Working fan temperature:

- -25 °C +60 °C.
- Working temperature (VSD):
-25 °C +50 °C.

Finish:

- Anticorrosive finish in polyester resin polymerised at 190°C, after alkaline degreasing with nanotechnology treatment and phosphate-free.

On request:

- Motor, impeller and guard unit (version F)
- Motor-impeller unit (version G)
- Airflow direction from impeller to motor.

Order code with variable speed drive (VSD) included

HEP/EW — 25 — 2/H — B — T — D

HEP/EW: High-efficiency wall-mounted axial fans "Efficient work"

Impeller diameter in cm.

Maximum speed:
2=2850 rpm
4=1410 rpm
6=960 rpm

H=High airflow
L=Low airflow

Industrial Brushless Motors E.C.

M: Fitted with VSD1/B, electronic variable speed, single phase power supply 220-240 V 50/60 Hz.
T: Fitted with VSD3/B, electronic variable speed, three-phase power supply 380-415 V 50/60 Hz.

D: Standard version, VSD supplied programmed for constant speed.
P: Supplied with VSD programmed for pressure control and Si-Presión pressure transmitter
K: Supplied with VSD programmed for pressure control and built into a BOXPRES KIT/B box.

Technical characteristics

Model	Speed min/max (r/min)	Single-phase VSD 230 V50/60 Hz		Three-phase VSD 400 V50/60 Hz		Maximum electrical power (W)	Maximum Airflow min/max (m³/h)	Sound pressure level min/max dB(A)	Weight approx. (Kg)
		Maximum current input (A)	Model VSD	Maximum current input (A)	Model VSD				
HEP/EW-25-2/H	300 / 2850	2.09	VSD1/B-0.37	0.61	VSD3/B-0.75	255	240 / 2300	15 / 64	5.3
HEP/EW-25-4/H	300 / 1410	1.14	VSD1/B-0.37	0.34	VSD3/B-0.75	140	265 / 1250	18 / 52	4.5
HEP/EW-31-2/H	300 / 2850	2.86	VSD1/B-0.37	0.84	VSD3/B-0.75	345	420 / 4000	25 / 74	7.0
HEP/EW-31-4/H	300 / 1410	1.14	VSD1/B-0.37	0.34	VSD3/B-0.75	140	510 / 2400	21 / 55	5.7
HEP/EW-35-2/H	300 / 2850	4.08	VSD1/B-0.37	1.20	VSD3/B-0.75	495	635 / 6020	27 / 76	8.8
HEP/EW-35-4/H	300 / 1410	1.14	VSD1/B-0.37	0.34	VSD3/B-0.75	140	745 / 3500	24 / 58	7.1
HEP/EW-40-4/H	300 / 1410	2.79	VSD1/B-0.37	0.82	VSD3/B-0.75	340	1105 / 5200	27 / 61	10.6
HEP/EW-40-6/H	300 / 960	2.13	VSD1/B-0.37	0.62	VSD3/B-0.75	255	1095 / 3500	29 / 54	10.2
HEP/EW-45-4/H	300 / 1410	3.96	VSD1/B-0.37	0.93	VSD3/B-0.75	450	1555 / 7300	32 / 66	12.5
HEP/EW-45-4/L	300 / 1410	2.79	VSD1/B-0.37	0.82	VSD3/B-0.75	340	1235 / 5810	30 / 64	11.0
HEP/EW-45-6/H	300 / 960	2.13	VSD1/B-0.37	0.62	VSD3/B-0.75	255	1530 / 4900	31 / 56	11.4
HEP/EW-50-4/H	300 / 1410	5.82	VSD1/B-0.75	1.37	VSD3/B-1.5	660	2160 / 10150	35 / 69	15.0
HEP/EW-50-4/L	300 / 1410	2.79	VSD1/B-0.37	0.82	VSD3/B-0.75	340	1555 / 7300	33 / 67	13.0
HEP/EW-50-6/H	300 / 960	2.13	VSD1/B-0.37	0.62	VSD3/B-0.75	255	1920 / 6150	34 / 59	13.2



EFFICIENT WORK



Technical characteristics

Model	Speed min/max (r/min)	Single-phase VSD 230 V50/60 Hz		Three-phase VSD 400 V50/60 Hz		Maximum electrical power (W)	Maximum airflow min/max (m³/h)	Sound pressure level min/max dB(A)	Weight approx. (Kg)
		Maximum current input (A)	Model VSD	Maximum current input (A)	Model VSD				
HEP/EW-56-4/H	300 / 1410	7.94	VSD1/B-0.75	1.87	VSD3/B-1.5	905	2725 / 12800	38 / 72	21.0
HEP/EW-56-4/L	300 / 1410	5.82	VSD1/B-0.75	1.37	VSD3/B-1.5	660	2320 / 10900	36 / 70	19.0
HEP/EW-56-6/H	300 / 960	2.93	VSD1/B-0.37	0.68	VSD3/B-0.75	330	2580 / 8250	37 / 62	17.0
HEP/EW-63-4/H	300 / 1410	11.25	VSD1/B-0.75	2.65	VSD3/B-1.5	1295	3980 / 18700	48 / 82	25.8
HEP/EW-63-4/L	300 / 1410	7.94	VSD1/B-0.75	1.87	VSD3/B-1.5	905	3510 / 16500	41 / 75	23.0
HEP/EW-63-6/H	300 / 960	4.28	VSD1/B-0.75	1.00	VSD3/B-1.5	480	3765 / 12050	40 / 65	20.2

Dimensions in mm

Standard version with connection box

Version on request without connection box

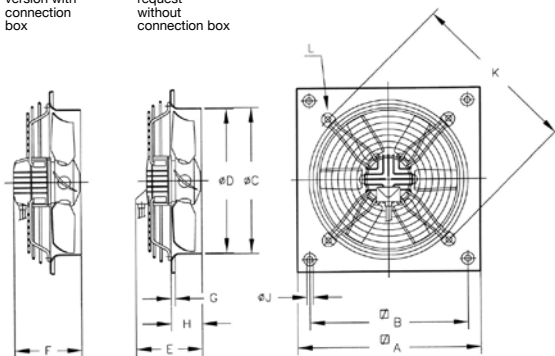

	A	B	C	D	E	F	G	H	J	K	L
HEP/EW-25-2/H	330	275	262	260	189	213	11	56	8.5	310	M.8
HEP/EW-25-4/H	330	275	262	260	179	203	11	56	8.5	310	M.8
HEP/EW-31-2/H	400	336	310.5	308	190	214	11	75	10.5	380	M.8
HEP/EW-31-4/H	400	336	310.5	308	180	204	11	75	10.5	380	M.8
HEP/EW-35-2/H	465	390	362.5	360	217	241	11	86	10.5	450	M.8
HEP/EW-35-4/H	465	390	362.5	360	187	211	11	86	10.5	450	M.8
HEP/EW-40-4/H	532	452	412.5	410	206	226	11	97.5	10.5	500	M.8
HEP/EW-40-6/H	532	452	412.5	410	186	205	11	97.5	10.5	500	M.8
HEP/EW-45-4/H	596	504	462.5	460	214	234	11	105	10.5	560	M.8
HEP/EW-45-4/L	596	504	462.5	460	214	234	11	105	10.5	560	M.8
HEP/EW-45-6/H	596	504	462.5	460	199	218	11	105	10.5	560	M.8
HEP/EW-50-4/H	665	562	516.5	514	255	275	11	115	10.5	640	M.8
HEP/EW-50-4/L	665	562	516.5	514	240	260	11	115	10.5	640	M.8
HEP/EW-50-6/H	665	562	516.5	514	235	254	11	115	10.5	640	M.8
HEP/EW-56-4/H	710	630	563	560	287	306	15	115	10.5	721	M.8
HEP/EW-56-4/L	710	630	563	560	267	286	15	115	10.5	721	M.8
HEP/EW-56-6/H	710	630	563	560	247	266	15	115	10.5	721	M.8
HEP/EW-63-4/H	800	710	638	635	320	340	15	140	10.5	820	M.8
HEP/EW-63-4/L	800	710	638	635	320	340	15	140	10.5	820	M.8
HEP/EW-63-6/H	800	710	638	635	257	276	15	140	10.5	820	M.8

Acoustic features at maximum speed

The specified values are determined according to free field measurements of sound levels in dB(A) at an equivalent distance of twice the fan's span plus the impeller's diameter, with a minimum of 1.5 m.

Sound power Lw(A) spectrum in dB(A) via frequency band in Hz.

Model	63	125	250	500	1000	2000	4000	8000	Model	63	125	250	500	1000	2000	4000	8000
HEP/EW-25-2/H	39	52	64	68	70	70	66	58	HEP/EW-45-6/H	33	47	59	62	64	65	61	52
HEP/EW-25-4/H	27	40	52	56	58	58	54	46	HEP/EW-50-4/H	46	60	72	75	77	78	74	65
HEP/EW-31-2/H	49	62	74	78	80	80	76	68	HEP/EW-50-4/L	44	58	70	73	75	76	72	63
HEP/EW-31-4/H	30	43	55	59	61	61	57	49	HEP/EW-50-6/H	36	50	62	65	67	68	64	55
HEP/EW-35-2/H	51	64	76	80	82	82	78	70	HEP/EW-56-4/H	49	63	75	78	80	81	77	68
HEP/EW-35-4/H	33	46	58	62	64	64	60	52	HEP/EW-56-4/L	47	61	73	76	78	79	75	66
HEP/EW-40-4/H	36	49	61	65	67	67	63	55	HEP/EW-56-6/H	39	53	65	68	70	71	67	58
HEP/EW-40-6/H	29	42	54	58	60	60	56	48	HEP/EW-63-4/H	61	75	87	90	92	92	89	80
HEP/EW-45-4/H	43	57	69	72	74	75	71	62	HEP/EW-63-4/L	54	68	80	83	85	85	82	73
HEP/EW-45-4/L	41	55	67	70	72	73	69	60	HEP/EW-63-6/H	44	58	70	73	75	75	72	63



Erp. Characteristic curves and ErP data

See HEP/EW-HEPT/EW model characteristic curves

Accessories

See accessories section.



HEPT/EW



VARIABLE SPEED DRIVE
VSD: Variable Speed Drive.
· VSD1/B
· VSD3/B

Supply included with fan

CONTROL
Supply optional accessory

SUPPLY
VSD1/B:
220-240 V 50/60 Hz
VSD3/B:
380-415 V 50/60 Hz

High-efficiency long-cased axial fans fitted with industrial Brushless motor E.C.

Fibreglass-reinforced plastic impeller.

Fan:

- Airflow direction from motor to impeller.
- Impeller in polyamide 6 reinforced with fibreglass.
- Sheet steel long casing.
- Outside connecting box, IP-65 protection.
- Electronic variable speed (VSD), three-phase or single-phase, is supplied with fan.

Motor and electronic variable speed:

- High-efficiency Industrial Brushless Motors E.C., fitted with electronic variable speed (VSD), adjustable via external control input 0-10V.
- It is advisable to install an electronic variable speed drive (VSD) outside the working area.
- The external signal can be supplied through a manual or automatic control with 0-10 V output.
- Electronic variable speed drive (VSD), available with single-phase 220-240 V 50/60 Hz input (VSD1/B type) or three-phase 380-415 V 50/60 Hz (VSD3/B type).

- By default, the electronic variable speed drive (VSD) is delivered programmed for constant speed.
- Working fan temperature: -25 °C +60 °C.
- Working temperature (VSD): -25 °C +50 °C.

Finish:

- Anticorrosive finish in polyester resin polymerised at 190°C, after alkaline degreasing with nanotechnology treatment and phosphate-free.

On request:

- Motor, impeller and guard unit (version F)
- Airflow direction from impeller to motor.

Order code with variable speed drive (VSD) included

HEPT/EW — 31 — 2/H — B — T — D

HEPT/EW: High-efficiency long-cased axial fans, "Efficient work"

Impeller diameter in cm.

Maximum speed:
2=2850 rpm
4=1410 rpm
6=960 rpm

H=High airflow
L=Low airflow

Industrial Brushless Motors E.C.

M: Fitted with VSD1/B, electronic variable speed, single phase power supply 220-240 V 50/60 Hz.

T: Fitted with VSD3/B, electronic variable speed, three-phase power supply 380-415 V 50/60 Hz.

D: Standard version, VSD supplied programmed for constant speed.

P: Supplied with VSD programmed for pressure control and Si-Presión

pressure transmitter

K: Supplied with VSD programmed for pressure control and built into a

BOXPRES KIT/B box.

Technical characteristics

Model	Speed min/max (r/min)	Single-phase VSD 230 V 50/60 Hz		Three-phase VSD 400 V 50/60 Hz		Maximum electrical power (W)	Maximum airflow min/max (m³/h)	Sound pressure level min/max dB(A)	Weight approx. (Kg)
		Maximum current input (A)	Model VSD	Maximum current input (A)	Model VSD				
HEPT/EW-31-2/H	300 / 2850	2.86	VSD1/B-0.37	0.84	VSD3/B-0.75	345	420 / 4000	25 / 74	7.4
HEPT/EW-31-4/H	300 / 1410	1.14	VSD1/B-0.37	0.34	VSD3/B-0.75	140	510 / 2400	21 / 55	6.2
HEPT/EW-35-2/H	300 / 2850	4.08	VSD1/B-0.37	1.20	VSD3/B-0.75	495	635 / 6020	27 / 76	9.4
HEPT/EW-35-4/H	300 / 1410	1.14	VSD1/B-0.37	0.34	VSD3/B-0.75	140	745 / 3500	24 / 58	7.6
HEPT/EW-40-4/H	300 / 1410	2.79	VSD1/B-0.37	0.82	VSD3/B-0.75	340	1105 / 5200	27 / 61	13.5
HEPT/EW-40-6/H	300 / 960	2.13	VSD1/B-0.37	0.62	VSD3/B-0.75	255	1095 / 3500	29 / 54	13.5
HEPT/EW-45-4/H	300 / 1410	3.96	VSD1/B-0.37	0.93	VSD3/B-0.75	450	1555 / 7300	32 / 66	15.5
HEPT/EW-45-4/L	300 / 1410	2.79	VSD1/B-0.37	0.82	VSD3/B-0.75	340	1235 / 5810	30 / 64	15.5
HEPT/EW-45-6/H	300 / 960	2.13	VSD1/B-0.37	0.62	VSD3/B-0.75	255	1530 / 4900	31 / 56	15.5
HEPT/EW-50-4/H	300 / 1410	5.82	VSD1/B-0.75	1.37	VSD3/B-1.5	660	2160 / 10150	35 / 69	18.0
HEPT/EW-50-4/L	300 / 1410	2.79	VSD1/B-0.37	0.82	VSD3/B-0.75	340	1555 / 7300	33 / 67	18.0
HEPT/EW-50-6/H	300 / 960	2.13	VSD1/B-0.37	0.62	VSD3/B-0.75	255	1920 / 6150	34 / 59	18.0
HEPT/EW-56-4/H	300 / 1410	7.94	VSD1/B-0.75	1.87	VSD3/B-1.5	905	2725 / 12800	38 / 72	28.0



EFFICIENT WORK



Technical characteristics

Model	Speed min/max (r/min)	Single-phase VSD 230 V 50/60 Hz		Three-phase VSD 400 V 50/60 Hz		Maximum electrical power (W)	Maximum airflow min/max (m³/h)	Sound pressure level min/max dB(A)	Weight approx. (Kg)
		Maximum current input (A)	Model VSD	Maximum current input (A)	Model VSD				
HEPT/EW-56-4/L	300 / 1410	5.82	VSD1/B-0.75	1.37	VSD3/B-1.5	660	2320 / 10900	36 / 70	28.0
HEPT/EW-56-6/H	300 / 960	2.93	VSD1/B-0.37	0.68	VSD3/B-0.75	330	2580 / 8250	37 / 62	28.0
HEPT/EW-63-4/H	300 / 1410	11.25	VSD1/B-0.75	2.65	VSD3/B-1.5	1295	3980 / 18700	48 / 82	33.5
HEPT/EW-63-4/L	300 / 1410	7.94	VSD1/B-0.75	1.87	VSD3/B-1.5	905	3510 / 16500	41 / 75	33.5
HEPT/EW-63-6/H	300 / 960	4.28	VSD1/B-0.75	1.00	VSD3/B-1.5	480	3765 / 12050	40 / 65	33.5

Acoustic features at maximum speed

The specified values are determined according to free field measurements of pressure and sound levels in dB(A) at an equivalent distance of twice the fan's span plus the impeller's diameter, with a minimum of 1.5 m.

Sound power Lw(A) spectrum in dB(A) via frequency band in Hz.

Model	63	125	250	500	1000	2000	4000	8000	Model	63	125	250	500	1000	2000	4000	8000
HEPT/EW-31-2/H	49	62	74	78	80	80	76	68	HEPT/EW-50-4/H	46	60	72	75	77	78	74	65
HEPT/EW-31-4/H	30	43	55	59	61	61	57	49	HEPT/EW-50-4/L	44	58	70	73	75	76	72	63
HEPT/EW-35-2/H	51	64	76	80	82	82	78	70	HEPT/EW-50-6/H	36	50	62	65	67	68	64	55
HEPT/EW-35-4/H	33	46	58	62	64	64	60	52	HEPT/EW-56-4/H	49	63	75	78	80	81	77	68
HEPT/EW-40-4/H	36	49	61	65	67	67	63	55	HEPT/EW-56-4/L	47	61	73	76	78	79	75	66
HEPT/EW-40-6/H	29	42	54	58	60	60	56	48	HEPT/EW-56-6/H	39	53	65	68	70	71	67	58
HEPT/EW-45-4/H	43	57	69	72	74	75	71	62	HEPT/EW-63-4/H	61	75	87	90	92	92	89	80
HEPT/EW-45-4/L	41	55	67	70	72	73	69	60	HEPT/EW-63-4/L	54	68	80	83	85	85	82	73
HEPT/EW-45-6/H	33	47	59	62	64	65	61	52	HEPT/EW-63-6/H	44	58	70	73	75	75	72	63

Dimensions in mm

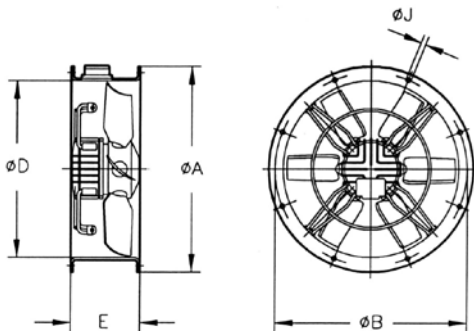

Model	ØA	ØB	ØD	E	ØJ	Drills No.
HEPT/EW-31	385	355	308	200	10	8
HEPT/EW-35	425	395	360	220	10	8
HEPT/EW-40	490	450	410	220	12	8
HEPT/EW-45	540	500	460	220	12	8
HEPT/EW-50	600	560	514	230	12	12
HEPT/EW-56	660	620	560	260	12	12
HEPT/EW-63	730	690	635	350	12	12



Erp. Characteristic curves and ErP data

See HEP/EW-HEPT/EW model characteristic curves

Accessories

See accessories section.



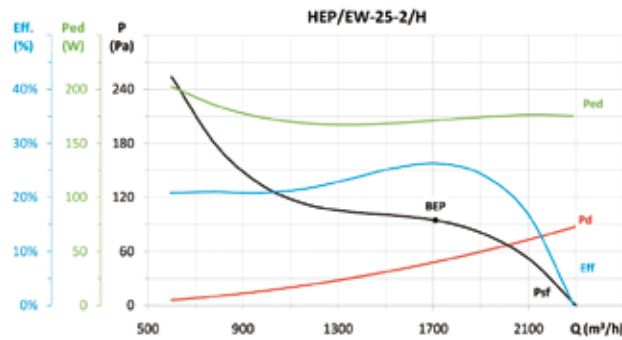

Erp. Characteristic curves and ErP data
HEP/EW-HEPT/EW models

MC	EC	SR	Cc	η_b (%)*	N	[kW]	[m³/h]	[Pa]	[rpm]	VSD
A	S	1,00	1,14	29,9%	41,1	0,171	1709	94,7	2850	INCLUDED

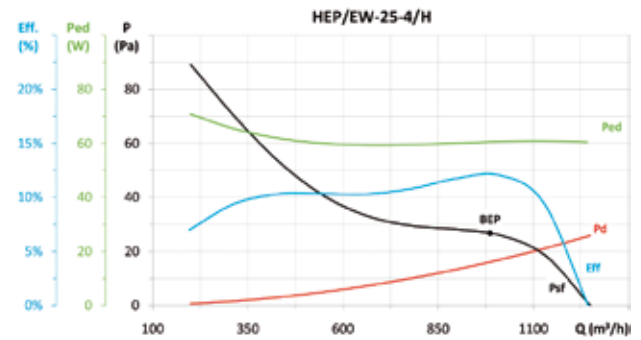
* η_e (%) = Eff. (%) x Cc

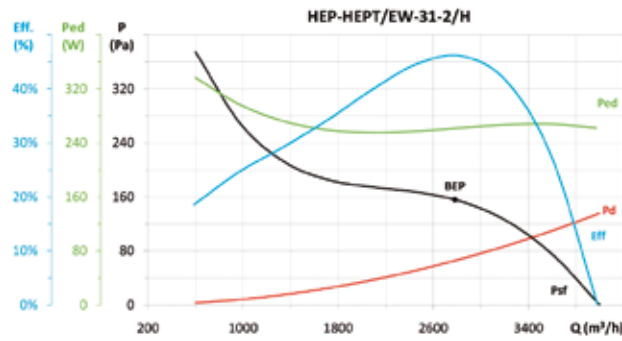

MC	EC	SR	Cc	η_b (%)*	N	[kW]	[m³/h]	[Pa]	[rpm]	VSD
A	S	-	-	-	-	0,061	986	26,8	1410	INCLUDED



MC	EC	SR	Cc	η_b (%)*	N	[kW]	[m³/h]	[Pa]	[rpm]	VSD
A	S	1,00	1,13	52,0%	62,0	0,261	2782	155,9	2850	INCLUDED

* η_e (%) = Eff. (%) x Cc

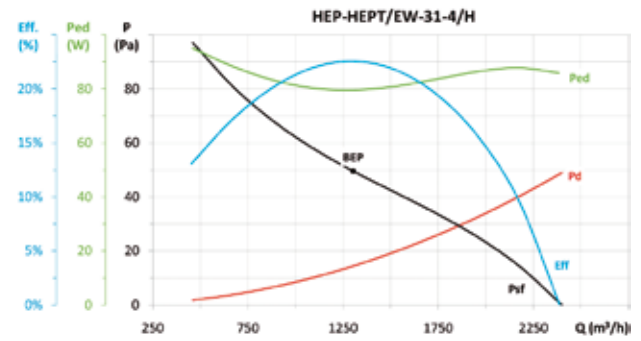

MC	EC	SR	Cc	η_b (%)*	N	[kW]	[m³/h]	[Pa]	[rpm]	VSD
A	S	-	-	-	-	0,080	1304	49,5	1410	INCLUDED

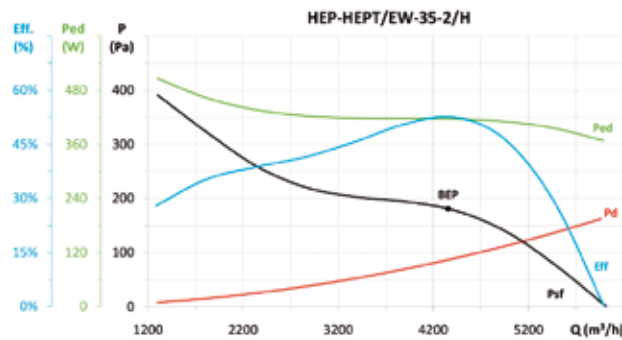

MC	EC	SR	Cc	η_b (%)*	N	[kW]	[m³/h]	[Pa]	[rpm]	VSD
A	S	1,00	1,11	58,5%	67,3	0,417	4356	181,1	2850	INCLUDED

* η_e (%) = Eff. (%) x Cc

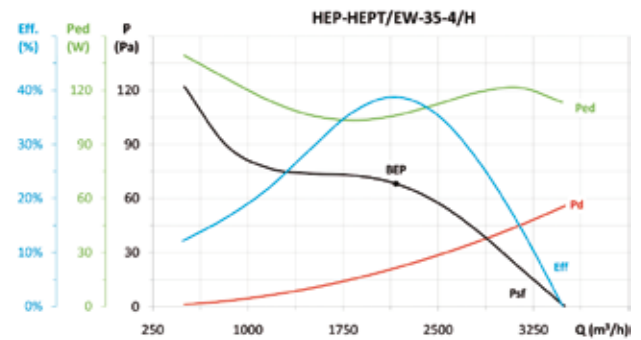

MC	EC	SR	Cc	η_b (%)*	N	[kW]	[m³/h]	[Pa]	[rpm]	VSD
A	S	-	-	-	-	0,106	2167	68,2	1410	INCLUDED

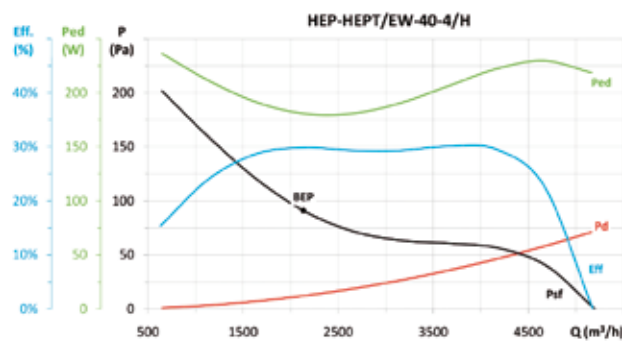

MC	EC	SR	Cc	η_b (%)*	N	[kW]	[m³/h]	[Pa]	[rpm]	VSD
A	S	1,00	1,14	34,0%	45,0	0,181	2135	91,0	1410	INCLUDED

* η_e (%) = Eff. (%) x Cc

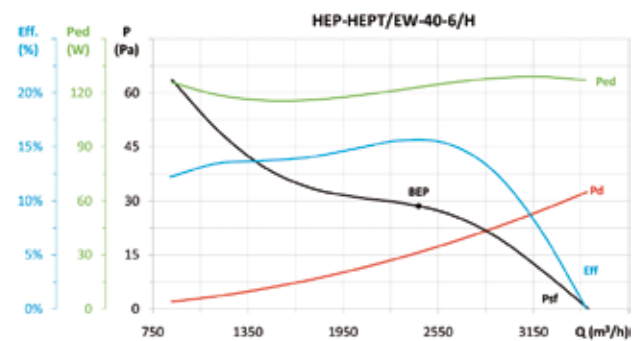

MC	EC	SR	Cc	η_b (%)*	N	[kW]	[m³/h]	[Pa]	[rpm]	VSD
A	S	-	-	-	-	0,123	2428	28,6	960	INCLUDED



EFFICIENT WORK



Erp. Characteristic curves and ErP data

HEP/EW-HEPT/EW models

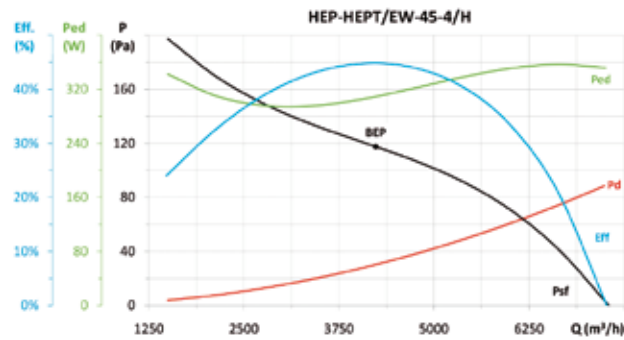

MC	EC	SR	Cc	η_e (%)*	N	[kW]	[m³/h]	[Pa]	[rpm]	VSD
A	S	1,00	1,12	50,3%	59,8	0,309	4235	117,6	1410	INCLUDED

* η_e (%) = EFF. (%) x Cc

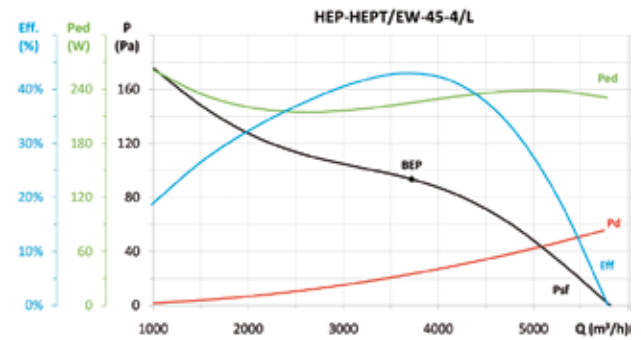

MC	EC	SR	Cc	η_e (%)*	N	[kW]	[m³/h]	[Pa]	[rpm]	VSD
A	S	1,00	1,13	48,6%	59,0	0,225	3719	93,5	1410	INCLUDED

* η_e (%) = EFF. (%) x Cc

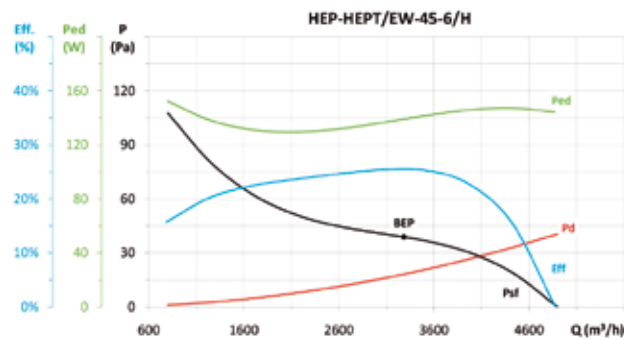

MC	EC	SR	Cc	η_e (%)*	N	[kW]	[m³/h]	[Pa]	[rpm]	VSD
A	S	1,00	1,15	29,3%	41,0	0,139	3284	38,9	960	INCLUDED

* η_e (%) = EFF. (%) x Cc

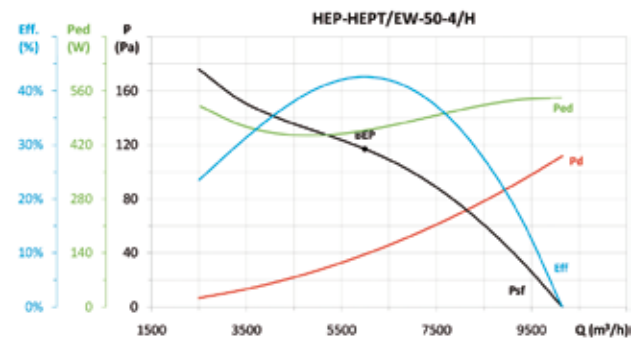

MC	EC	SR	Cc	η_e (%)*	N	[kW]	[m³/h]	[Pa]	[rpm]	VSD
A	S	1,00	1,11	47,3%	55,8	0,457	5994	117,0	1410	INCLUDED

* η_e (%) = EFF. (%) x Cc

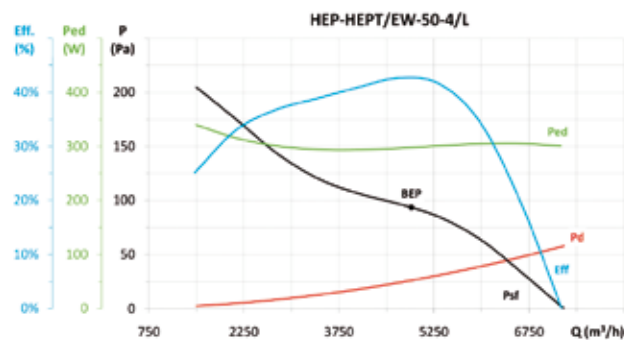

MC	EC	SR	Cc	η_e (%)*	N	[kW]	[m³/h]	[Pa]	[rpm]	VSD
A	S	1,00	1,12	48,0%	57,7	0,298	4894	93,6	1410	INCLUDED

* η_e (%) = EFF. (%) x Cc

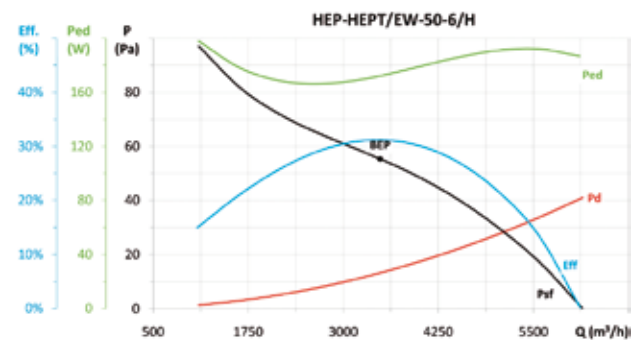

MC	EC	SR	Cc	η_e (%)*	N	[kW]	[m³/h]	[Pa]	[rpm]	VSD
A	S	1,00	1,14	35,5%	46,7	0,172	3484	55,4	960	INCLUDED

* η_e (%) = EFF. (%) x Cc

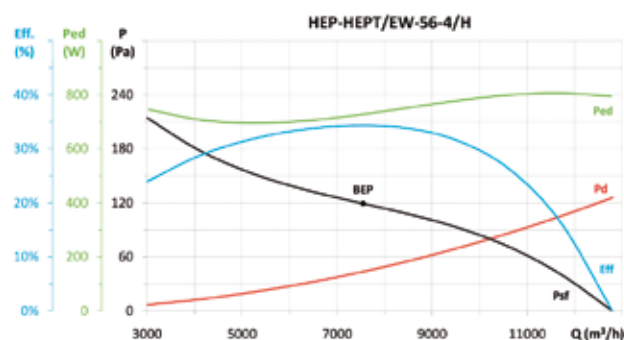

MC	EC	SR	Cc	η_e (%)*	N	[kW]	[m³/h]	[Pa]	[rpm]	VSD
A	S	1,00	1,10	37,7%	44,9	0,728	7546	119,3	1410	INCLUDED

* η_e (%) = EFF. (%) x Cc

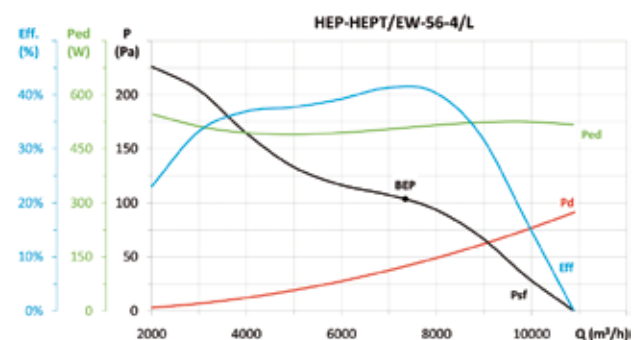

MC	EC	SR	Cc	η_e (%)*	N	[kW]	[m³/h]	[Pa]	[rpm]	VSD
A	S	1,00	1,11	46,0%	54,2	0,509	7344	103,7	1410	INCLUDED

* η_e (%) = EFF. (%) x Cc



Erp. Characteristic curves and ErP data

HEP/EW-HEPT/EW models

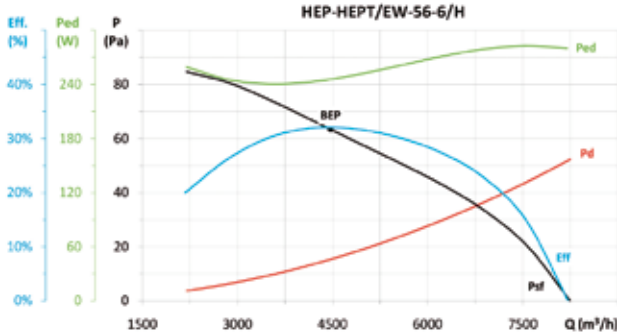

MC	EC	SR	Cc	η_e (%)*	N	[kW]	[m³/h]	[Pa]	[rpm]	VSD
A	S	1,00	1,13	36,2%	46,4	0,245	4469	63,4	960	INCLUDED

* η_e (%) = Eff. (%) x Cc

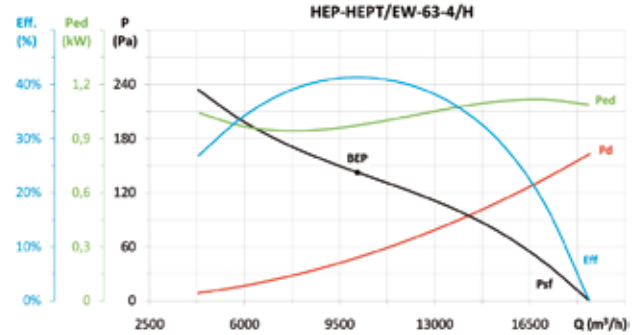

MC	EC	SR	Cc	η_e (%)*	N	[kW]	[m³/h]	[Pa]	[rpm]	VSD
A	S	1,00	1,09	44,9%	51,3	0,973	10152	142,4	1410	INCLUDED

* η_e (%) = Eff. (%) x Cc

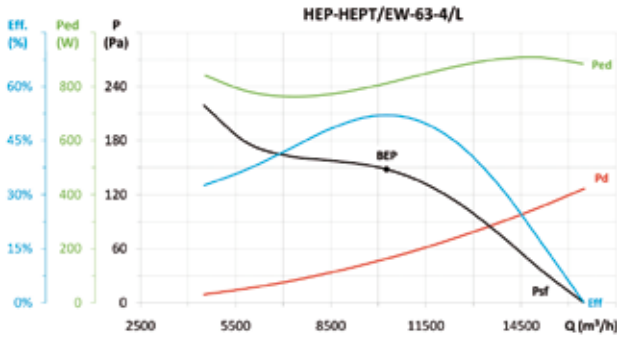

MC	EC	SR	Cc	η_e (%)*	N	[kW]	[m³/h]	[Pa]	[rpm]	VSD
A	S	1,00	1,09	56,9%	63,8	0,812	10263	148,1	1410	INCLUDED

* η_e (%) = Eff. (%) x Cc

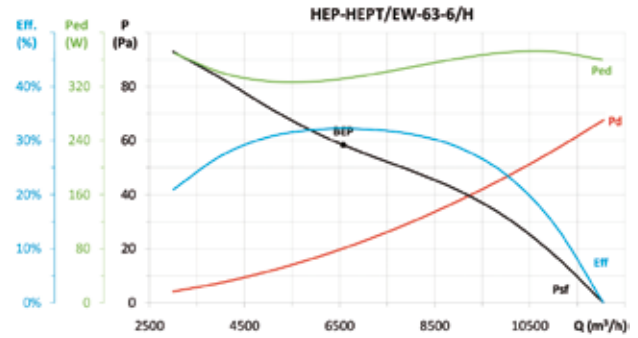

MC	EC	SR	Cc	η_e (%)*	N	[kW]	[m³/h]	[Pa]	[rpm]	VSD
A	S	1,00	1,12	36,0%	45,4	0,332	6577	58,4	960	INCLUDED

* η_e (%) = Eff. (%) x Cc



EFFICIENT WORK



HC/EW



**HIGHLY EFFICIENT
IE3-COMPLIANT
THREE-PHASE MOTORS**

Wall-mounted axial fans fitted with high-efficiency IE3 asynchronous motor adjustable electronically

Fibreglass-reinforced plastic impeller.

Fan:

- Airflow direction from motor to impeller.
- Impeller in polyamide 6 reinforced with fibreglass.
- Sheet steel base plate.
- Protection guard to prevent contacts according to standard UNE 100250 as an accessory.

Motor and electronic variable speed:

- Motors with IE3 efficiency adjustable electronically.
- The variable speed drive VSD will be supplied as per order.
- Electronic variable speed drive (VSD) can be adjusted by external 0-10 V signal.
- It is advisable to install sinusoidal filters between the fan and the electronic variable speed drive (VSD) when they are far apart.
- It is advisable to install an electronic variable speed drive (VSD) outside the working area.
- The external signal can be supplied through a manual or automatic control with 0-10 V output.
- Electronic variable speed drive (VSD), available with single-phase 220-240 V 50/60 Hz input (VSD1/B type) or three-phase 380-415 V 50/60 Hz (VSD3/B type).
- By default, the electronic variable speed drive (VSD) is delivered programmed for constant speed.

Working fan temperature:

- -25 °C +60 °C.
- Working temperature (VSD): -25 °C +50 °C.
- Class F motors with ball bearings, IP55 protection.
- Three-phase 230/400 V 50 Hz (up to 5.5 CV) and 400/690 V. 50 Hz. (power over 5.5 CV.)

Finish:

- Anticorrosive finish in polyester resin polymerised at 190°C, after alkaline degreasing with nanotechnology treatment and phosphate-free.

On request:

- Motor, impeller and guard unit (version F)
- Motor, impeller and guard unit (version G).
- Airflow direction from impeller to motor.



VARIABLE SPEED DRIVE
VSD: Variable Speed Drive.
• VSD1/A-RFM
• VSD3/A-RFT
Supply on request

CONTROL
Supply optional accessory

SUPPLY
VSD1/A-RFM:
220-240 V 50/60 Hz
VSD3/A-RFT:
380-415 V 50/60 Hz

Fan order code

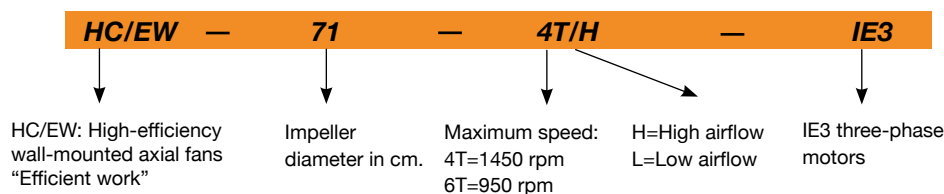

Order code with variable speed drive (VSD) included

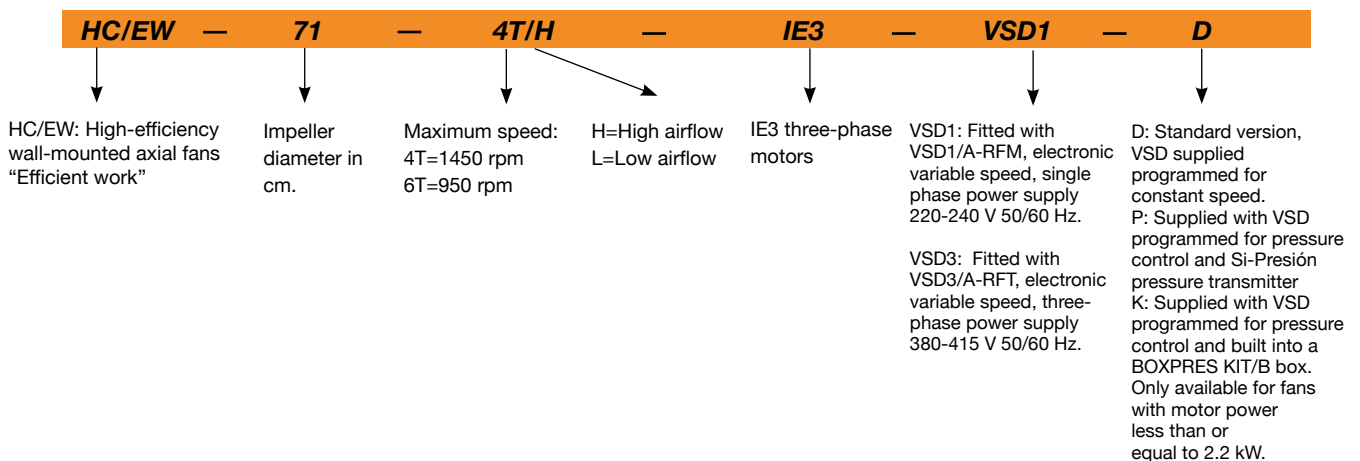

Technical characteristics

Model	Speed min/max (r/min)	Single-phase VSD 230 V 50/60 Hz		Three-phase VSD 400 V 50/60 Hz		Maximum current Motor 50 Hz			Installed power (kW)	Maximum airflow min/max (m³/h)	Sound pressure level min/max dB(A)	Weight approx. (Kg)
		Maximum current input (A)	VSD model	Maximum current input (A)	VSD model	230V (A)	400V (A)	690V (A)				
HC/EW-71-4T/H	575/1440	15.78	VSD1/A-RFM-2	4.38	VSD3/A-RFT-2	5.41	3.11	-	1.50	8905 / 22300	58 / 78	35
HC/EW-71-6T/H	375/940	8.69	VSD1/A-RFM-1	2.41	VSD3/A-RFT-1	3.36	1.93	-	0.75	6980 / 17500	46 / 66	36
HC/EW-80-4T/H	575/1440	-	-	7.20	VSD3/A-RFT-5.5	10.70	6.15	-	3.00	13175 / 33000	62 / 82	55
HC/EW-80-4T/L	575/1440	15.78	VSD1/A-RFM-2	4.38	VSD3/A-RFT-2	5.41	3.11	-	1.50	9985 / 25000	59 / 79	44
HC/EW-80-6T/H	375/940	8.69	VSD1/A-RFM-1	2.41	VSD3/A-RFT-1	3.36	1.93	-	0.75	8775 / 22000	51 / 71	45
HC/EW-80-6T/L	370/925	6.90	VSD1/A-RFM-1	1.92	VSD3/A-RFT-1	2.52	1.45	-	0.55	7680 / 19200	50 / 70	39
HC/EW-90-4T/H	580/1450	-	-	9.48	VSD3/A-RFT-5.5	13.90	8.00	-	4.00	17400 / 43500	66 / 86	68
HC/EW-90-4T/L	575/1440	-	-	7.20	VSD3/A-RFT-5.5	10.70	6.15	-	3.00	13495 / 33800	63 / 83	63
HC/EW-90-6T/H	380/950	16.64	VSD1/A-RFM-2	4.62	VSD3/A-RFT-2	6.43	3.70	-	1.50	13320 / 33300	56 / 76	60
HC/EW-90-6T/L	380/945	12.43	VSD1/A-RFM-2	3.45	VSD3/A-RFT-2	4.68	2.69	-	1.10	10535 / 26200	53 / 73	55
HC/EW-100-4T/H	585/1465	-	-	12.81	VSD3/A-RFT-7.5	-	10.30	5.97	5.50	21565 / 54000	68 / 88	85
HC/EW-100-4T/L	580/1450	-	-	9.48	VSD3/A-RFT-5.5	13.90	8.00	-	4.00	17000 / 42500	64 / 84	71
HC/EW-100-6T/H	380/950	16.64	VSD1/A-RFM-2	4.62	VSD3/A-RFT-2	6.43	3.70	-	1.50	14800 / 37000	58 / 78	63
HC/EW-100-6T/L	380/945	12.43	VSD1/A-RFM-2	3.45	VSD3/A-RFT-2	4.68	2.69	-	1.10	11300 / 28100	56 / 76	73

Acoustic features at maximum speed

The specified values are determined according to free field measurements of sound levels in dB(A) at an equivalent distance of twice the fan's span plus the impeller's diameter, with a minimum of 1.5 m.

Sound power Lw(A) spectrum in dB(A) via frequency band in Hz.

Model	63	125	250	500	1000	2000	4000	8000	Model	63	125	250	500	1000	2000	4000	8000
HC/EW-71-4T/H	47	64	77	84	89	90	85	78	HC/EW-90-4T/L	54	75	82	87	90	86	79	68
HC/EW-71-6T/H	35	52	65	72	77	78	73	66	HC/EW-90-6T/H	61	82	89	94	97	93	86	75
HC/EW-80-4T/H	60	81	88	93	96	92	85	74	HC/EW-90-6T/L	51	72	79	84	87	83	76	85
HC/EW-80-4T/L	49	70	77	82	85	81	74	63	HC/EW-100-4T/H	68	88	96	101	103	100	93	82
HC/EW-80-6T/H	57	78	85	90	93	89	82	71	HC/EW-100-4T/L	58	78	86	91	93	90	83	72
HC/EW-80-6T/L	48	69	76	81	84	80	73	62	HC/EW-100-6T/H	64	84	92	97	99	96	89	78
HC/EW-90-4T/H	64	85	92	97	100	96	89	78	HC/EW-100-6T/L	56	76	84	89	91	88	81	70

Dimensions in mm

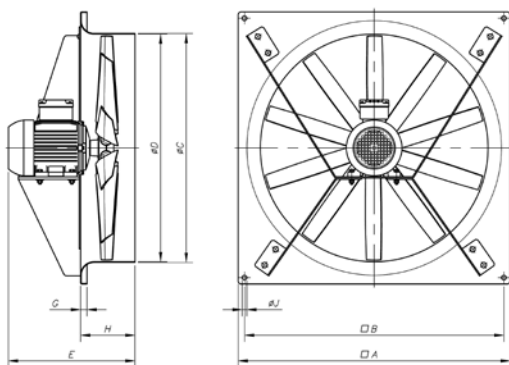

Model	∅A	∅B	∅C	∅D	E	G	H	∅J
HC/EW-71-4T/H	850	810	715	711	395	20	170	14.5
HC/EW-71-6T/H	850	810	715	711	395	20	170	14.5
HC/EW-80-4T/H	970	910	801	797	488	20	210	14.5
HC/EW-80-4T/L	970	910	801	797	458	20	210	14.5
HC/EW-80-6T/H	970	910	801	797	458	20	210	14.5
HC/EW-80-6T/L	970	910	801	797	416	20	210	14.5
HC/EW-90-4T/H	1170	1110	918	914	511	20	210	14.5
HC/EW-90-4T/L	1170	1110	918	914	488	20	210	14.5
HC/EW-90-6T/H	1170	1110	918	914	488	20	210	14.5
HC/EW-90-6T/L	1170	1110	918	914	455	20	210	14.5
HC/EW-100-4T/H	1170	1110	1003	999	548	20	220	14.5
HC/EW-100-4T/L	1170	1110	1003	999	521	20	220	14.5
HC/EW-100-6T/H	1170	1110	1003	999	498	20	220	14.5
HC/EW-100-6T/L	1170	1110	1003	999	468	20	220	14.5



EFFICIENT WORK



Erp. Characteristic curves and ErP data

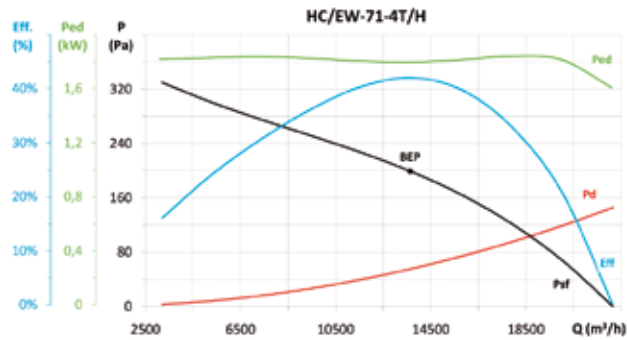

MC	EC	SR	Cc	η_e (%)*	N	[kW]	[m³/h]	[Pa]	[rpm]	VSD
C	S	1,00	1,07	44,9%	49,6	1,796	13627	199,3	1441	NECESSARY

* η_e (%) = Eff. (%) x Cc

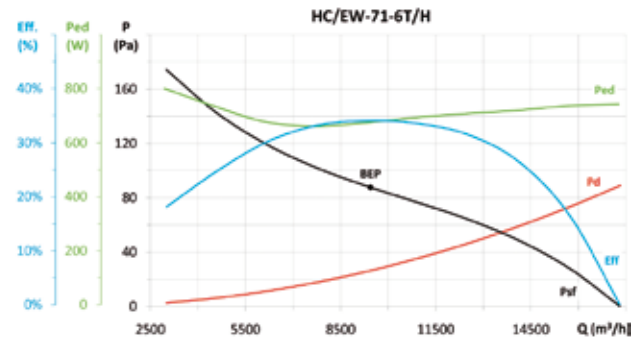

MC	EC	SR	Cc	η_e (%)*	N	[kW]	[m³/h]	[Pa]	[rpm]	VSD
C	S	1,00	1,10	37,4%	44,8	0,675	9443	87,7	959	NECESSARY

* η_e (%) = Eff. (%) x Cc

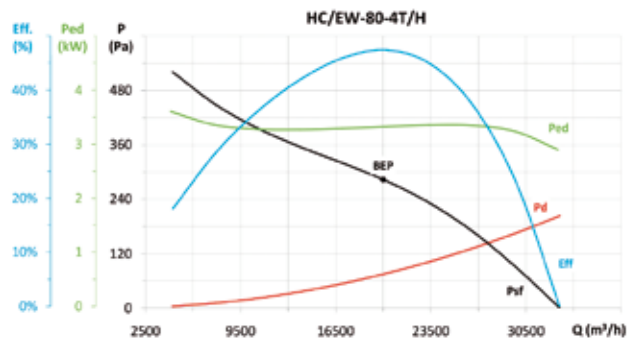

MC	EC	SR	Cc	η_e (%)*	N	[kW]	[m³/h]	[Pa]	[rpm]	VSD
C	S	1,00	1,05	49,8%	52,9	3,321	19996	283,5	1444	NECESSARY

* η_e (%) = Eff. (%) x Cc

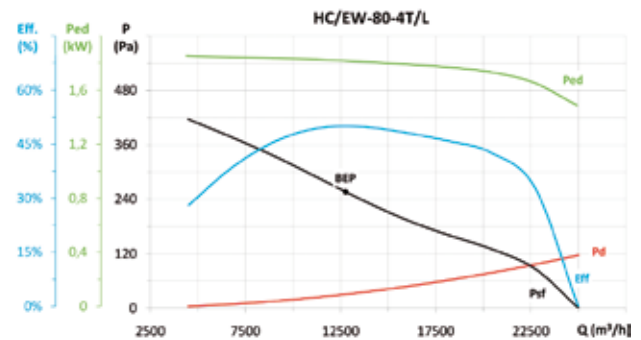

MC	EC	SR	Cc	η_e (%)*	N	[kW]	[m³/h]	[Pa]	[rpm]	VSD
C	S	1,00	1,07	53,5%	58,2	1,818	12760	256,6	1440	NECESSARY

* η_e (%) = Eff. (%) x Cc

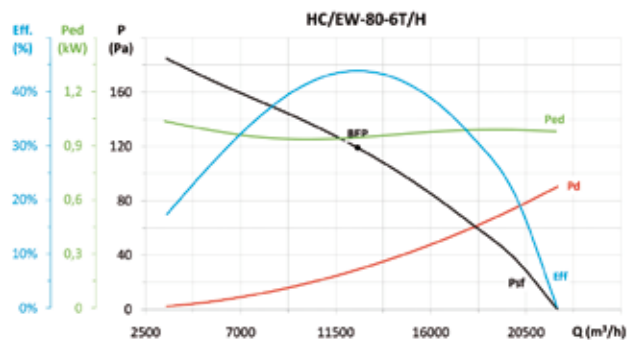

MC	EC	SR	Cc	η_e (%)*	N	[kW]	[m³/h]	[Pa]	[rpm]	VSD
C	S	1,00	1,09	47,7%	54,2	0,945	12533	119,1	943	NECESSARY

* η_e (%) = Eff. (%) x Cc

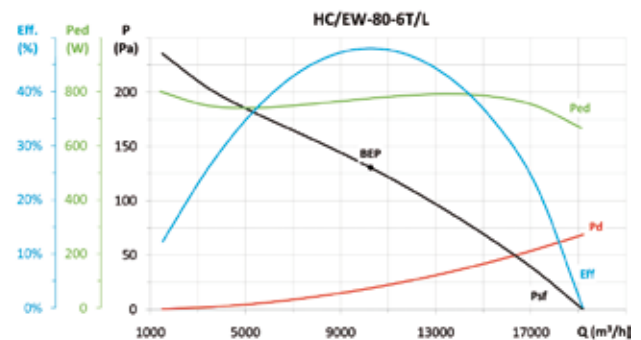

MC	EC	SR	Cc	η_e (%)*	N	[kW]	[m³/h]	[Pa]	[rpm]	VSD
C	S	1,00	1,10	52,6%	59,6	0,775	10262	130,5	927	NECESSARY

* η_e (%) = Eff. (%) x Cc

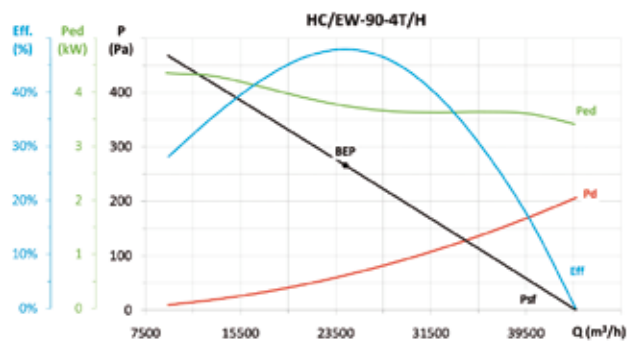

MC	EC	SR	Cc	η_e (%)*	N	[kW]	[m³/h]	[Pa]	[rpm]	VSD
C	S	1,00	1,05	50,2%	52,9	3,751	24299	266,4	1460	NECESSARY

* η_e (%) = Eff. (%) x Cc

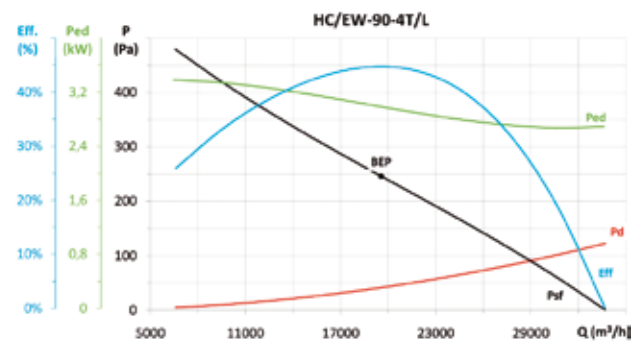

MC	EC	SR	Cc	η_e (%)*	N	[kW]	[m³/h]	[Pa]	[rpm]	VSD
C	S	1,00	1,06	47,2%	50,5	2,989	19552	246,3	1450	NECESSARY

* η_e (%) = Eff. (%) x Cc



Erp. Characteristic curves and ErP data

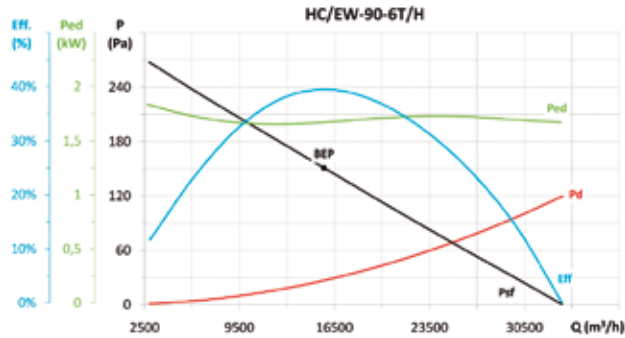

MC	EC	SR	Cc	η_e (%)*	N	[kW]	[m ³ /h]	[Pa]	[rpm]	VSD
C	S	1,00	1,07	42,3%	47,2	1,670	15731	150,9	956	NECESSARY

* η_e (%) = Eff. (%) x Cc

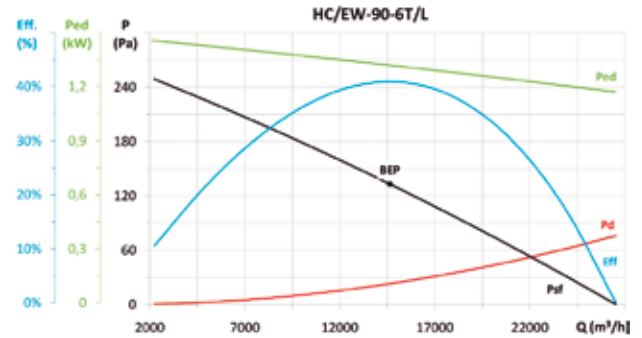

MC	EC	SR	Cc	η_e (%)*	N	[kW]	[m ³ /h]	[Pa]	[rpm]	VSD
C	S	1,00	1,08	44,1%	49,7	1,320	14635	132,9	949	NECESSARY

* η_e (%) = Eff. (%) x Cc

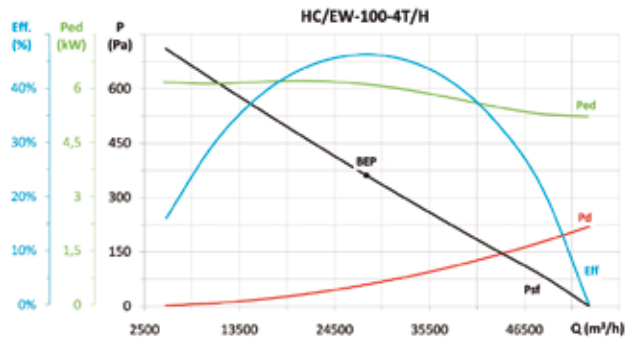

MC	EC	SR	Cc	η_e (%)*	N	[kW]	[m ³ /h]	[Pa]	[rpm]	VSD
C	S	1,00	1,04	48,0%	49,4	6,119	28190	361,3	1466	NECESSARY

* η_e (%) = Eff. (%) x Cc

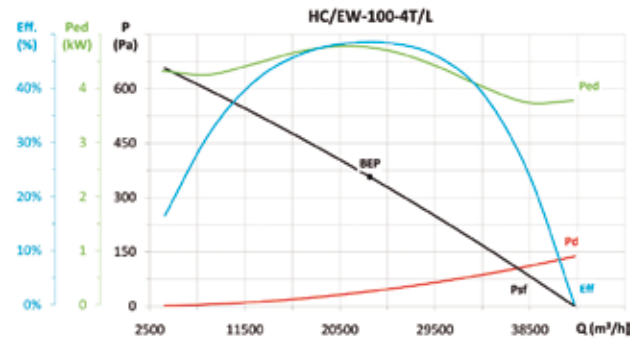

MC	EC	SR	Cc	η_e (%)*	N	[kW]	[m ³ /h]	[Pa]	[rpm]	VSD
C	S	1,00	1,04	50,5%	52,6	4,763	23348	356,7	1450	NECESSARY

* η_e (%) = Eff. (%) x Cc

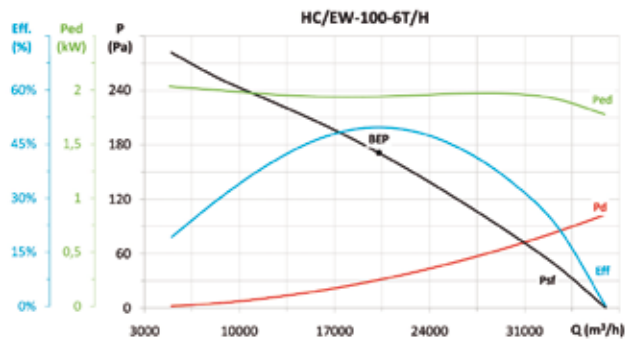

MC	EC	SR	Cc	η_e (%)*	N	[kW]	[m ³ /h]	[Pa]	[rpm]	VSD
C	S	1,00	1,07	53,0%	57,5	1,940	20265	171,1	949	NECESSARY

* η_e (%) = Eff. (%) x Cc

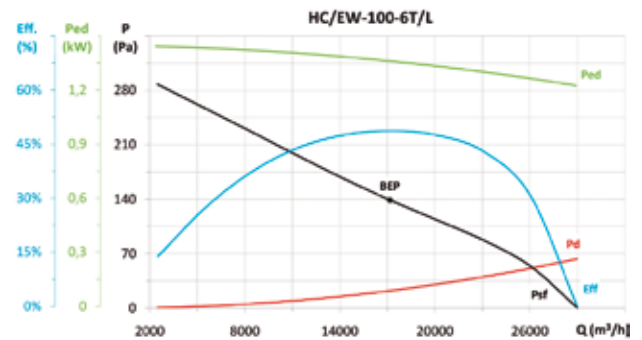

MC	EC	SR	Cc	η_e (%)*	N	[kW]	[m ³ /h]	[Pa]	[rpm]	VSD
C	S	1,00	1,08	52,4%	57,9	1,362	17161	139,0	948	NECESSARY

* η_e (%) = Eff. (%) x Cc

Accessories

See accessories section.



INT



VSD1/A-RFM
VSD3/A-RFT



AET



PL



P



R



RI



S



CONTROL UNITS
AND SENSORS



EFFICIENT WORK



HCH-HCT-HFT/EW



**HIGHLY EFFICIENT
IE3-COMPLIANT
THREE-PHASE MOTORS**



VARIABLE SPEED DRIVE
VSD: Variable Speed Drive.
. VSD1/A-RFM
. VSD3/A-RFT
Supply on request

CONTROL
Supply optional accessory

SUPPLY
VSD1/A-RFM:
220-240 V 50/60 Hz
VSD3/A-RFT:
380-415 V 50/60 Hz

Wall-mounted or long-cased axial fans fitted with high-efficiency IE3 asynchronous motor adjustable electronically.

Fan:

- Airflow direction from motor to impeller.
- PL version impellers in polyamide 6 reinforced with fibreglass and AL version in cast aluminium.
- HCH: Wall support ring in sheet steel with single clamp.
- HFT: Short casing in sheet steel with double clamp and packing boxes for cable entry
- HCT: Sheet steel long casing with external terminal board

Motor and electronic variable speed:

- Motors with IE3 efficiency adjustable electronically.
- The variable speed drive VSD will be supplied as per order.
- Electronic variable speed drive (VSD) can be adjusted by external 0-10 V signal.
- It is advisable to install an electronic variable speed drive (VSD) outside the working area.
- The external signal can be supplied through a manual or automatic control with 0-10 V output.
- It is advisable to install sinusoidal filters between the fan and the electronic variable speed drive (VSD) when they are far apart.
- Electronic variable speed drive (VSD), available with single-phase 220-240 V 50/60 Hz input (VSD1/B type) or three-phase 380-415 V 50/60 Hz (VSD3/B type).

- By default, the electronic variable speed drive (VSD) is delivered programmed for constant speed.
- Working fan temperature: -25 °C +60 °C.
- Working temperature (VSD): -25 °C +50 °C.
- Class F motors with ball bearings, IP55 protection.
- Three-phase 230/400 V. 50 Hz. (up to 5.5 CV) and 400/690 V. 50 Hz. (power over 5.5 CV)

Finish:

- Anticorrosive finish in polyester resin polymerised at 190°C, after alkaline degreasing with nanotechnology treatment and phosphate-free.

On request:

- Airflow direction from impeller to motor
- 100% reversible impellers.

Fan order code

HCH/EW — 71 — 4T — 1.5 / AL — IE3

↓	↓	↓	↓	↓	↓	↓
HCH/EW: High-efficiency wall-mounted axial fans "Efficient work"	Impeller diameter in cm.	Maximum speed: 4T=1450 rpm 6T=950 rpm	Motor power (CV)	AL: Aluminium impeller PL: Plastic impeller	Three-phase motor IE3	
HFT/EW: High-efficiency axial fans with double clamp, "Efficient work"						
HCT/EW: High-efficiency long-cased axial fans, "Efficient work"						

Order code with variable speed drive (VSD) included

HCH/EW — 71 — 4T — 1.5 / AL — IE3 — VSD1 — D

↓	↓	↓	↓	↓	↓	↓	↓
HCH/EW: High-efficiency wall-mounted axial fans "Efficient work"	Impeller diameter in cm.	Maximum speed: 4T=1450 rpm 6T=950 rpm	Motor power (CV)	AL: Aluminium impeller PL: Plastic impeller	Three-phase motor IE3	VSD1: Fitted with VSD1/A-RFM, electronic variable speed drive, single phase power supply 220-240 V 50/60 Hz. VSD3: Fitted with VSD3/A-RFT, electronic variable speed drive, three-phase power supply 380-415 V 50/60 Hz.	D: Standard version, VSD supplied programmed for constant speed. P: Supplied with VSD programmed for pressure control and Si-Presión pressure transmitter K: Supplied with VSD programmed for pressure control and built into a BOXPRES KIT/B box. Only available for fans with motor power less than or equal to 2.2 kW.
HFT/EW: High-efficiency axial fans with double clamp, "Efficient work"							
HCT/EW: High-efficiency long-cased axial fans, "Efficient work"							

Technical characteristics

Model	Speed min/max (r/min)	Single-phase VSD 230 V 50/60 Hz		Three-phase VSD 400 V 50/60 Hz		Maximum current Motor 50 Hz 230V 400V 690V (A)		Installed power (kW)	Maximum airflow min/max (m³/h)	Sound pressure level min/max dB(A)	Weight approx. (Kg)						
		Maximum current input (A)	Model VSD	Maximum current input (A)	Model VSD	230V	400V				690V	HCH	HFT	HCT			
HCH/EW	HFT/EW	HCT/EW	56-4T-0.75	570/1420	6.33	VSD1/A-RFM-1	1.76	VSD3/A-RFT-1	2.17	1.25	-	0.55	4435 / 11050	52 / 72	21	23	33
HCH/EW	HFT/EW	HCT/EW	56-4T-1	570/1420	8.32	VSD1/A-RFM-1	2.31	VSD3/A-RFT-1	2.82	1.62	-	0.75	5200 / 12950	53 / 73	22	24	34
HCH/EW	HFT/EW	HCT/EW	56-4T-1.5	580/1455	11.87	VSD1/A-RFM-2	3.30	VSD3/A-RFT-2	4.07	2.34	-	1.10	5580 / 14000	54 / 74	26	28	37
HCH/EW	HFT/EW	HCT/EW	63-4T-1	570/1420	8.32	VSD1/A-RFM-1	2.31	VSD3/A-RFT-1	2.82	1.62	-	0.75	5680 / 14150	53 / 73	27	29	42
HCH/EW	HFT/EW	HCT/EW	63-4T-1.5	580/1455	11.87	VSD1/A-RFM-2	3.30	VSD3/A-RFT-2	4.07	2.34	-	1.10	6775 / 17000	54 / 74	30	32	45
HCH/EW	HFT/EW	HCT/EW	63-4T-2	575/1440	15.78	VSD1/A-RFM-2	4.38	VSD3/A-RFT-2	5.41	3.11	-	1.50	7545 / 18900	55 / 75	33	35	48
HCH/EW	HFT/EW	HCT/EW	63-4T-3	575/1440	23.15	VSD1/A-RFM-3	6.43	VSD3/A-RFT-3	7.93	4.56	-	2.20	8855 / 22100	56 / 76	41	43	57
HCH/EW	HFT/EW	HCT/EW	71-4T-1.5	580/1455	11.87	VSD1/A-RFM-2	3.30	VSD3/A-RFT-2	4.07	2.34	-	1.10	7935 / 19900	58 / 78	33	35	52
HCH/EW	HFT/EW	HCT/EW	71-4T-2	575/1440	15.78	VSD1/A-RFM-2	4.38	VSD3/A-RFT-2	5.41	3.11	-	1.50	8385 / 21000	59 / 79	36	38	55
HCH/EW	HFT/EW	HCT/EW	71-4T-3	575/1435	23.15	VSD1/A-RFM-3	6.43	VSD3/A-RFT-3	7.93	4.56	-	2.20	9615 / 24000	61 / 81	45	47	64
HCH/EW	HFT/EW	HCT/EW	71-4T-4	575/1440	-	-	7.20	VSD3/A-RFT-5.5	10.70	6.15	-	3.00	11740 / 29400	62 / 82	47	49	66
HCH/EW	HFT/EW	HCT/EW	71-6T-0.75	370/925	6.90	VSD1/A-RFM-1	1.92	VSD3/A-RFT-1	2.52	1.45	-	0.55	6000 / 15000	47 / 67	29	31	49
HCH/EW	HFT/EW	HCT/EW	71-6T-1	375/940	8.69	VSD1/A-RFM-2	2.41	VSD3/A-RFT-1	3.36	1.93	-	0.75	6860 / 17200	48 / 68	36	38	55
HCH/EW	HFT/EW	HCT/EW	71-6T-1.5	380/945	12.43	VSD1/A-RFM-2	3.45	VSD3/A-RFT-2	4.68	2.69	-	1.10	8485 / 21100	49 / 69	38	40	57
HCH/EW	HFT/EW	HCT/EW	80-4T-3	575/1435	23.15	VSD1/A-RFM-3	6.43	VSD3/A-RFT-3	7.93	4.56	-	2.20	11820 / 29500	62 / 82	53	55	72
HCH/EW	HFT/EW	HCT/EW	80-4T-4	575/1440	-	-	7.20	VSD3/A-RFT-5.5	10.70	6.15	-	3.00	14775 / 37000	63 / 83	55	57	74
HCH/EW	HFT/EW	HCT/EW	80-4T-5.5	580/1450	-	-	9.48	VSD3/A-RFT-5.5	13.90	8.00	-	4.00	16200 / 40500	64 / 84	60	62	79
HCH/EW	HFT/EW	HCT/EW	80-6T-1	375/940	8.69	VSD1/A-RFM-1	2.41	VSD3/A-RFT-1	3.36	1.93	-	0.75	9175 / 23000	51 / 71	44	46	64
HCH/EW	HFT/EW	HCT/EW	80-6T-1.5	380/945	12.43	VSD1/A-RFM-2	3.45	VSD3/A-RFT-2	4.68	2.69	-	1.10	10455 / 26000	52 / 72	46	48	66
HCH/EW	HFT/EW	HCT/EW	80-6T-2	380/950	16.64	VSD1/A-RFM-2	4.62	VSD3/A-RFT-2	6.43	3.70	-	1.50	11880 / 29700	53 / 73	52	54	71
HCH/EW	HFT/EW	HCT/EW	80-6T-3	380/950	23.83	VSD1/A-RFM-3	6.62	VSD3/A-RFT-3	9.08	5.22	-	2.20	13400 / 33500	54 / 74	57	59	76
HCH/EW	HFT/EW	HCT/EW	90-4T-4	575/1440	-	-	7.20	VSD3/A-RFT-5.5	10.70	6.15	-	3.00	15970 / 40000	67 / 87	62	66	90
HCH/EW	HFT/EW	HCT/EW	90-4T-5.5	580/1450	-	-	9.48	VSD3/A-RFT-5.5	13.90	8.00	-	4.00	18600 / 46500	69 / 89	67	71	95
HCH/EW	HFT/EW	HCT/EW	90-4T-7.5	585/1465	-	-	12.81	VSD3/A-RFT-7.5	-	10.30	5.97	5.50	20365 / 51000	71 / 91	83	87	109
HCH/EW	HFT/EW	HCT/EW	90-4T-10	585/1465	-	-	17.32	VSD3/A-RFT-10	-	13.90	8.06	7.50	21845 / 54700	72 / 92	94	98	120
HCH/EW	HFT/EW	HCT/EW	90-6T-2	380/950	16.64	VSD1/A-RFM-2	4.62	VSD3/A-RFT-2	6.43	3.70	-	1.50	13720 / 34300	57 / 77	59	63	87
HCH/EW	HFT/EW	HCT/EW	90-6T-3	380/950	23.83	VSD1/A-RFM-3	6.62	VSD3/A-RFT-3	9.08	5.22	-	2.20	15200 / 38000	58 / 78	64	68	92
HCH/EW	HFT/EW	HCT/EW	90-6T-4	390/970	-	-	7.39	VSD3/A-RFT-5.5	12.00	6.91	-	3.00	17045 / 42400	59 / 79	88	92	114
HCH/EW	HFT/EW	HCT/EW	100-4T-7.5	585/1465	-	-	12.81	VSD3/A-RFT-7.5	-	10.30	5.97	5.50	21565 / 54000	72 / 92	91	95	121
HCH/EW	HFT/EW	HCT/EW	100-4T-10	585/1465	-	-	17.32	VSD3/A-RFT-10	-	13.90	8.06	7.50	25155 / 63000	73 / 93	102	106	131
HCH/EW	HFT/EW	HCT/EW	100-4T-15	590/1470	-	-	25.10	VSD3/A-RFT-15	-	21.40	12.40	11.00	27295 / 68000	74 / 94	125	129	160
HCH/EW	HFT/EW	HCT/EW	100-4T-20	585/1465	-	-	34.41	VSD3/A-RFT-20	-	28.70	16.60	15.00	28750 / 72000	75 / 95	144	148	179
HCH/EW	HFT/EW	HCT/EW	100-6T-3	380/950	23.83	VSD1/A-RFM-3	6.62	VSD3/A-RFT-3	9.08	5.22	-	2.20	17200 / 43000	62 / 82	72	76	103
HCH/EW	HFT/EW	HCT/EW	100-6T-4	390/970	-	-	7.39	VSD3/A-RFT-5.5	12.00	6.91	-	3.00	18895 / 47000	63 / 83	96	100	125
HCH/EW	HFT/EW	HCT/EW	100-6T-5.5	385/960	-	-	9.74	VSD3/A-RFT-5.5	15.60	8.99	-	4.00	21255 / 53000	64 / 84	104	108	133

Acoustic features at maximum speed

The specified values are determined according to free field measurements of pressure and sound levels in dB(A) at an equivalent distance of twice the fan's span plus the impeller's diameter, with a minimum of 1.5 m.

Sound power Lw(A) spectrum in dB(A) via frequency band in Hz.

Model	63	125	250	500	1000	2000	4000	8000	Model	63	125	250	500	1000	2000	4000	8000
56-4T-0.75	47	67	75	80	82	79	72	61	80-6T-1.5	49	69	77	82	84	81	74	63
56-4T-1	48	68	76	81	83	80	73	62	80-6T-2	50	70	78	83	85	82	75	64
56-4T-1.5	49	69	77	82	84	81	74	63	80-6T-3	51	71	79	84	86	83	76	65
63-4T-1	50	70	78	83	85	82	75	64	90-4T-4	65	86	93	98	101	97	90	79
63-4T-1.5	51	71	79	84	86	83	76	65	90-4T-5.5	67	88	95	100	103	99	92	81
63-4T-2	52	72	80	85	87	84	77	66	90-4T-7.5	69	90	97	102	105	101	94	83
63-4T-3	53	73	81	86	88	85	78	67	90-4T-10	70	91	98	103	106	102	95	84
71-4T-1.5	55	75	83	88	90	87	80	69	90-6T-2	55	76	83	88	91	87	80	69
71-4T-2	56	76	84	89	91	88	81	70	90-6T-3	56	77	84	89	92	88	81	70
71-4T-3	58	78	86	91	93	90	83	72	90-6T-4	57	78	85	90	93	89	82	71
71-4T-4	59	79	87	92	94	91	84	73	100-4T-7.5	72	92	100	105	107	104	97	86
71-6T-0.75	44	64	72	77	79	76	69	58	100-4T-10	73	93	101	106	108	105	98	87
71-6T-1	45	65	73	78	80	77	70	59	100-4T-15	74	94	102	107	109	106	99	88
71-6T-1.5	46	66	74	79	81	78	71	60	100-4T-20	75	95	103	108	110	107	100	89
80-4T-3	59	79	87	92	94	91	84	73	100-6T-3	62	82	90	95	97	94	87	76
80-4T-4	60	80	88	93	95	92	85	74	100-6T-4	63	83	91	96	98	95	88	77
80-4T-5.5	61	81	89	94	96	93	86	75	100-6T-5.5	64	84	92	97	99	96	89	78
80-6T-1	48	68	76	81	83	80	73	62									



EFFICIENT WORK



Dimensions in mm

HCH/EW

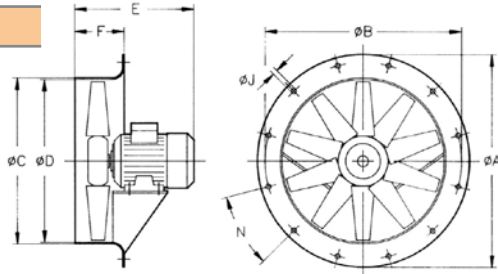

HFT/EW

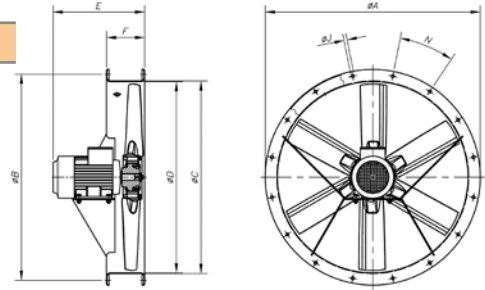

E

Model	ØA	ØB	ØC	ØD	0,75	1	1,5	2	3	4	5,5	7,5	10	15	20	F	ØJ	N
HCH/EW-56-4T	660	620	564	560	310	310	330									120	12	12 X 30°
HCH/EW-63-4T	730	690	645	640		325	325	355	405							150	12	12 X 30°
HCH/EW-71-4T	810	770	715	710			330	350	415	415						150	12	16 X 22°30'
HCH/EW-71-6T	810	770	715	710	315	330	350									150	12	16 X 22°30'
HCH/EW-80-4T	900	860	805	800					425	425	445					180	12	16 X 22°30'
HCH/EW-80-6T	900	860	805	800		355	375	425	445							180	12	16 X 22°30'
HCH/EW-90-4T	1015	970	906	900						425	430	465	465			180	15	16 X 22°30'
HCH/EW-90-6T	1015	970	906	900				425	430	465						180	15	16 X 22°30'
HCH/EW-100-4T	1115	1070	1006	1000							480	480	590	590		200	15	16 X 22°30'
HCH/EW-100-6T	1115	1070	1006	1000				440	480	480						200	15	16 X 22°30'
HFT/EW-56-4T	660	620	564	560	344	344	376									120	12	12 X 30°
HFT/EW-56-6T	660	620	564	560												120	12	12 X 30°
HFT/EW-63-4T	730	690	645	640		325	398	398	430	430						120	12	12 X 30°
HFT/EW-63-6T	730	690	645	640	325	398										120	12	12 X 30°
HFT/EW-71-4T	810	770	715	710			400	400	440	440						150	12	16 X 22°30'
HFT/EW-71-6T	810	770	715	710	325	400	400									150	12	16 X 22°30'
HFT/EW-80-4T	900	860	805	800					425	425	445					180	12	16 X 22°30'
HFT/EW-80-6T	900	860	805	800		390	390	425	445							180	12	16 X 22°30'
HFT/EW-90-4T	1015	970	906	900						430	440	470	470			180	15	16 X 22°30'
HFT/EW-90-6T	1015	970	906	900				430	440	470						180	15	16 X 22°30'
HFT/EW-100-4T	1115	1070	1006	1000							485	485	590	590		200	15	16 X 22°30'
HFT/EW-100-6T	1115	1070	1006	1000				440	485	485						200	15	16 X 22°30'

HCT/EW

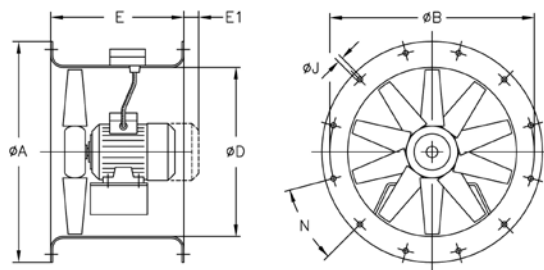

Model	ØA	ØB	ØD	E	ØJ	N
HCT/EW-56	660	620	560	400	12	12x30°
HCT/EW-63	730	690	640	430	12	12x30°
HCT/EW-71	810	770	710	500	12	16x22°30'
HCT/EW-80	900	860	800	500	12	16x22°30'
HCT/EW-90	1015	970	900	500	15	16x22°30'
HCT/EW-100	1115	1070	1000	550	15	16x22°30'
HCT/EW-100-4T-15	1115	1070	1000	650	15	16x22°30'
HCT/EW-100-4T-20	1115	1070	1000	650	15	16x22°30'



Erp. Characteristic curves and ErP data

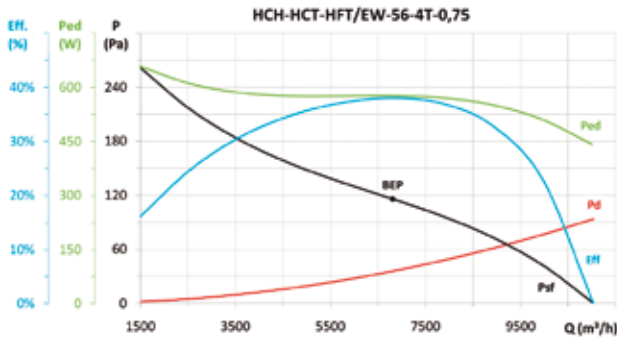

MC	EC	SR	Cc	η_e (%)*	N	[kW]	[m³/h]	[Pa]	[rpm]	VSD
A	S	1,00	1,10	41,9%	49,8	0,577	6808	115,8	1437	NECESSARY

* η_e (%) = Eff. (%) x Cc

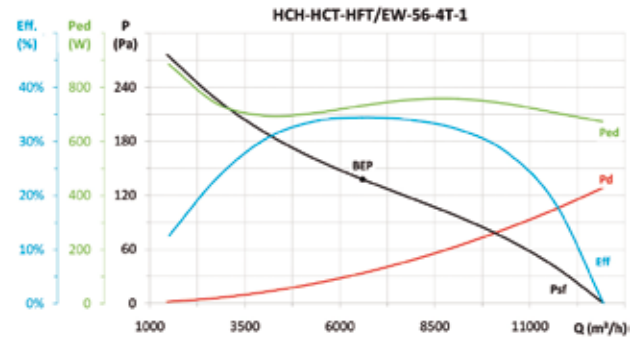

MC	EC	SR	Cc	η_e (%)*	N	[kW]	[m³/h]	[Pa]	[rpm]	VSD
A	S	1,00	1,10	37,8%	45,0	0,732	6599	137,7	1436	NECESSARY

* η_e (%) = Eff. (%) x Cc

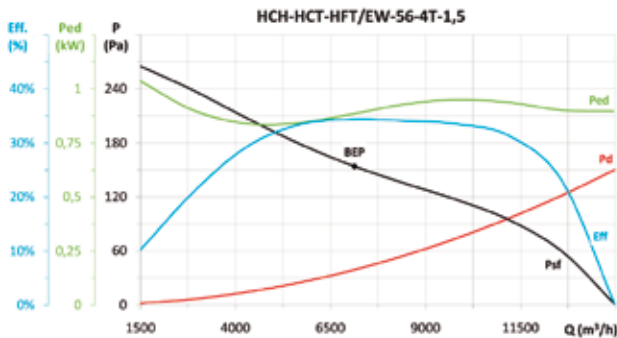

MC	EC	SR	Cc	η_e (%)*	N	[kW]	[m³/h]	[Pa]	[rpm]	VSD
A	S	1,00	1,09	37,5%	44,2	0,886	7130	153,9	1453	NECESSARY

* η_e (%) = Eff. (%) x Cc

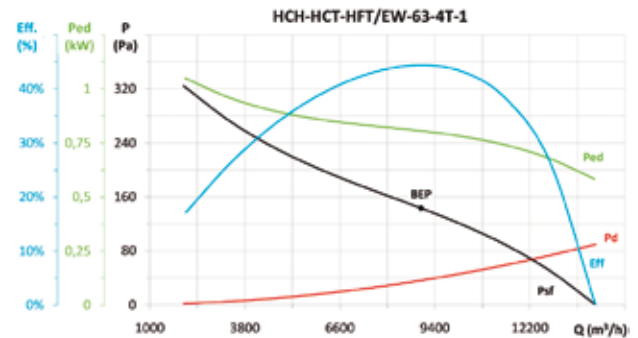

MC	EC	SR	Cc	η_e (%)*	N	[kW]	[m³/h]	[Pa]	[rpm]	VSD
A	S	1,00	1,09	48,5%	55,5	0,806	8989	143,3	1433	NECESSARY

* η_e (%) = Eff. (%) x Cc

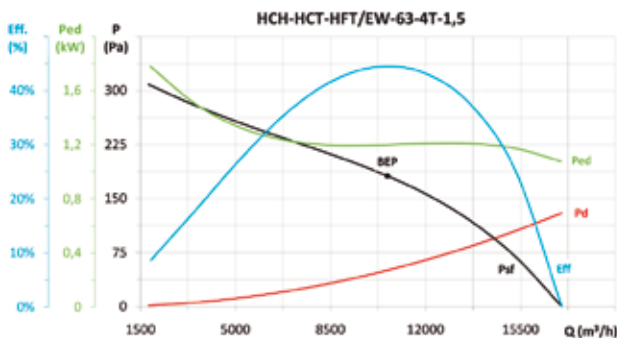

MC	EC	SR	Cc	η_e (%)*	N	[kW]	[m³/h]	[Pa]	[rpm]	VSD
A	S	1,00	1,08	48,1%	54,0	1,200	10593	181,5	1460	NECESSARY

* η_e (%) = Eff. (%) x Cc

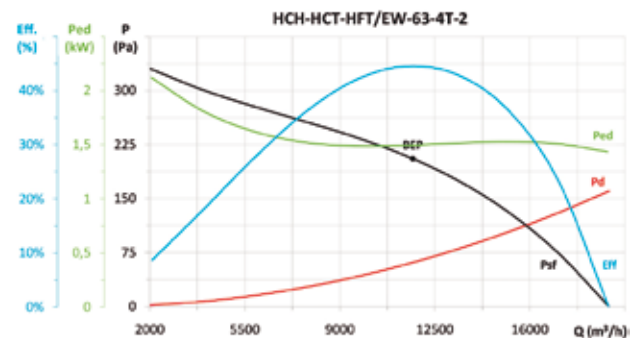

MC	EC	SR	Cc	η_e (%)*	N	[kW]	[m³/h]	[Pa]	[rpm]	VSD
A	S	1,00	1,08	47,9%	53,1	1,496	11688	205,4	1451	NECESSARY

* η_e (%) = Eff. (%) x Cc

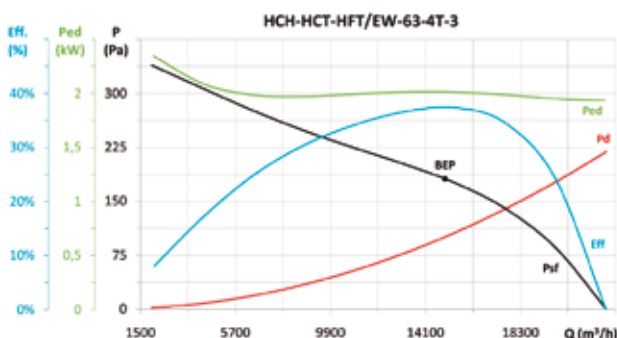

MC	EC	SR	Cc	η_e (%)*	N	[kW]	[m³/h]	[Pa]	[rpm]	VSD
A	S	1,00	1,07	39,8%	44,3	2,014	14963	181,1	1448	NECESSARY

* η_e (%) = Eff. (%) x Cc

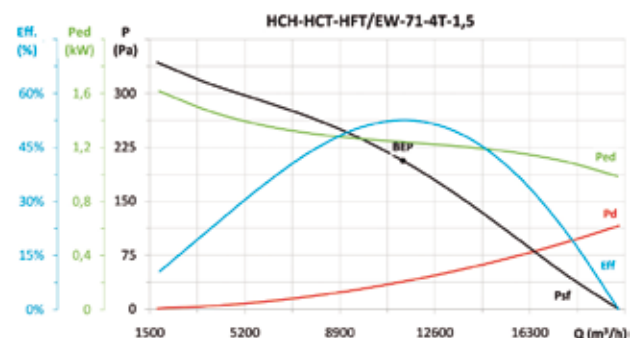

MC	EC	SR	Cc	η_e (%)*	N	[kW]	[m³/h]	[Pa]	[rpm]	VSD
A	S	1,00	1,08	56,8%	62,5	1,239	11355	206,4	1459	NECESSARY

* η_e (%) = Eff. (%) x Cc



EFFICIENT WORK



Erp. Characteristic curves and ErP data

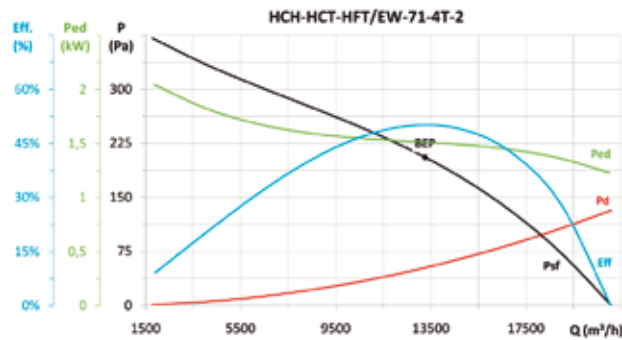

MC	EC	SR	Cc	η_a (%)*	N	[kW]	[m³/h]	[Pa]	[rpm]	VSD
A	S	1,00	1,08	53,8%	59,0	1,511	13256	205,5	1450	NECESSARY

* η_e (%) = Eff. (%) x Cc

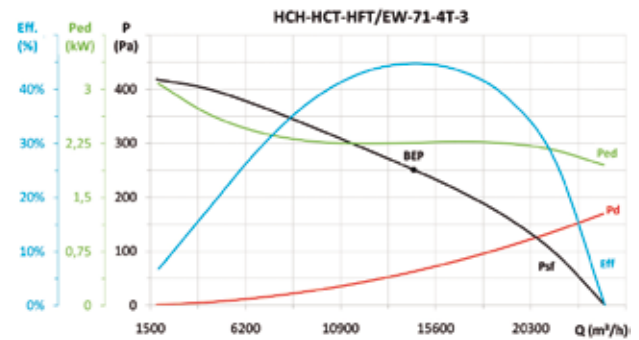

MC	EC	SR	Cc	η_a (%)*	N	[kW]	[m³/h]	[Pa]	[rpm]	VSD
A	S	1,00	1,06	47,6%	51,7	2,260	14513	251,0	1445	NECESSARY

* η_e (%) = Eff. (%) x Cc

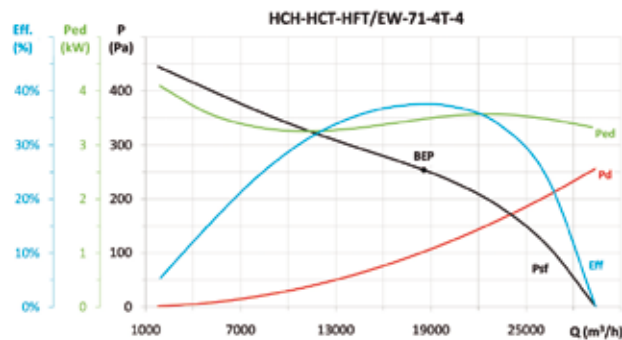

MC	EC	SR	Cc	η_a (%)*	N	[kW]	[m³/h]	[Pa]	[rpm]	VSD
A	S	1,00	1,05	39,4%	42,3	3,482	18556	253,6	1442	NECESSARY

* η_e (%) = Eff. (%) x Cc

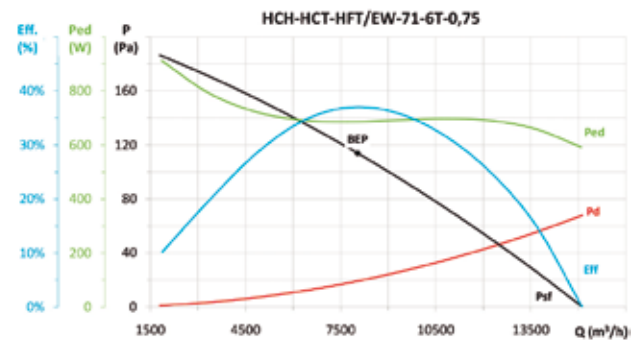

MC	EC	SR	Cc	η_a (%)*	N	[kW]	[m³/h]	[Pa]	[rpm]	VSD
A	S	1,00	1,10	40,7%	48,0	0,686	8036	113,8	935	NECESSARY

* η_e (%) = Eff. (%) x Cc

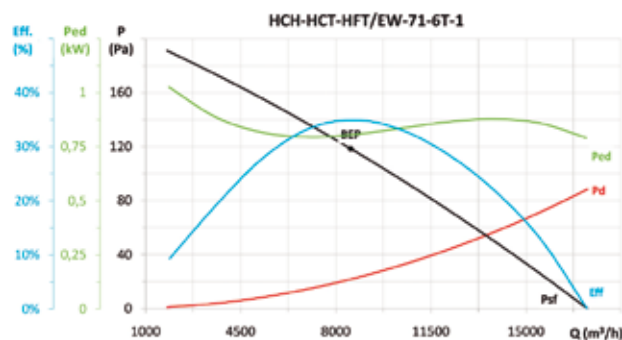

MC	EC	SR	Cc	η_a (%)*	N	[kW]	[m³/h]	[Pa]	[rpm]	VSD
A	S	1,00	1,09	38,2%	45,1	0,805	8550	118,5	952	NECESSARY

* η_e (%) = Eff. (%) x Cc

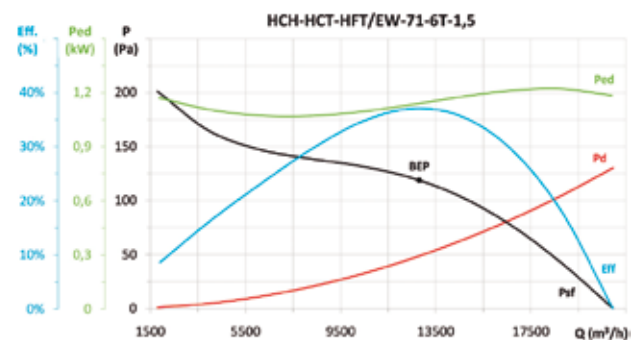

MC	EC	SR	Cc	η_a (%)*	N	[kW]	[m³/h]	[Pa]	[rpm]	VSD
A	S	1,00	1,08	40,2%	46,1	1,140	12806	118,8	956	NECESSARY

* η_e (%) = Eff. (%) x Cc

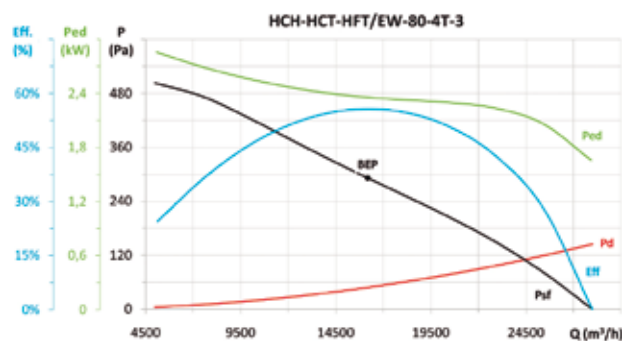

MC	EC	SR	Cc	η_a (%)*	N	[kW]	[m³/h]	[Pa]	[rpm]	VSD
A	S	1,00	1,06	59,1%	63,0	2,355	16178	291,7	1442	NECESSARY

* η_e (%) = Eff. (%) x Cc

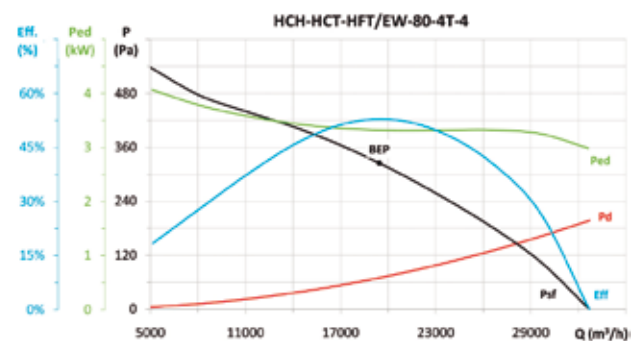

MC	EC	SR	Cc	η_a (%)*	N	[kW]	[m³/h]	[Pa]	[rpm]	VSD
A	S	1,00	1,05	55,5%	58,6	3,319	19442	324,8	1445	NECESSARY

* η_e (%) = Eff. (%) x Cc



Erp. Characteristic curves and ErP data

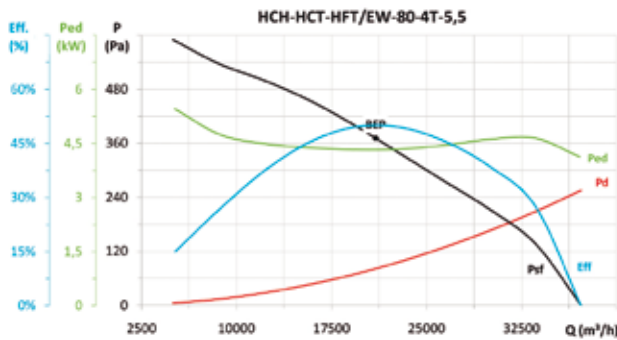

MC	EC	SR	Cc	η_e (%)*	N	[kW]	[m³/h]	[Pa]	[rpm]	VSD
A	S	1,00	1,04	52,2%	54,5	4,324	20980	371,3	1454	NECESSARY

* η_e (%) = Eff. (%) x Cc

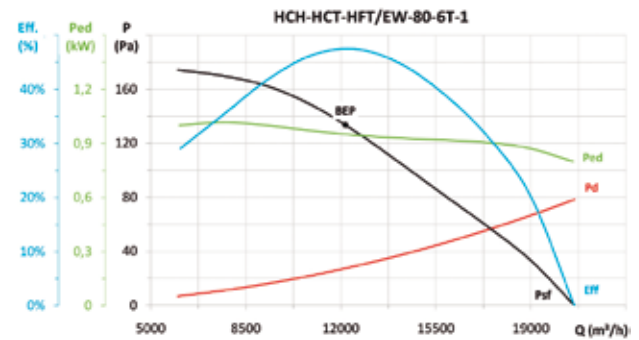

MC	EC	SR	Cc	η_e (%)*	N	[kW]	[m³/h]	[Pa]	[rpm]	VSD
A	S	1,00	1,09	51,7%	58,2	0,950	12168	133,6	943	NECESSARY

* η_e (%) = Eff. (%) x Cc

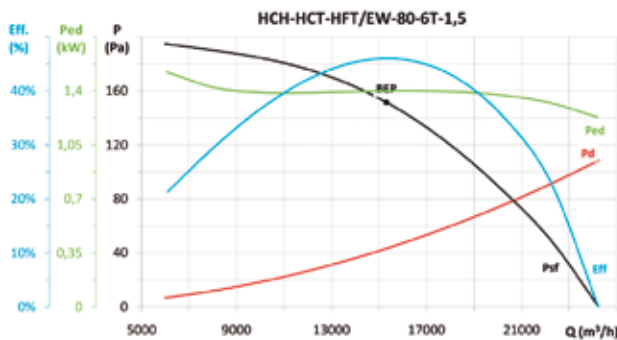

MC	EC	SR	Cc	η_e (%)*	N	[kW]	[m³/h]	[Pa]	[rpm]	VSD
A	S	1,00	1,08	49,6%	55,0	1,400	15312	151,5	946	NECESSARY

* η_e (%) = Eff. (%) x Cc

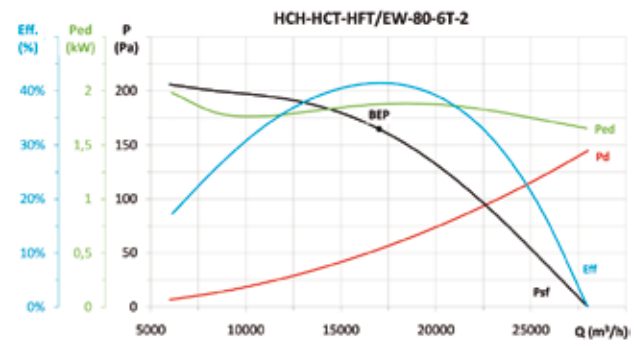

MC	EC	SR	Cc	η_e (%)*	N	[kW]	[m³/h]	[Pa]	[rpm]	VSD
A	S	1,00	1,07	44,3%	48,9	1,878	17013	164,7	951	NECESSARY

* η_e (%) = Eff. (%) x Cc

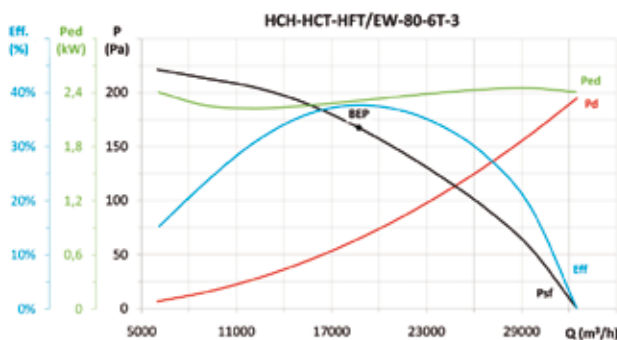

MC	EC	SR	Cc	η_e (%)*	N	[kW]	[m³/h]	[Pa]	[rpm]	VSD
A	S	1,00	1,06	40,0%	44,1	2,310	18724	167,5	955	NECESSARY

* η_e (%) = Eff. (%) x Cc

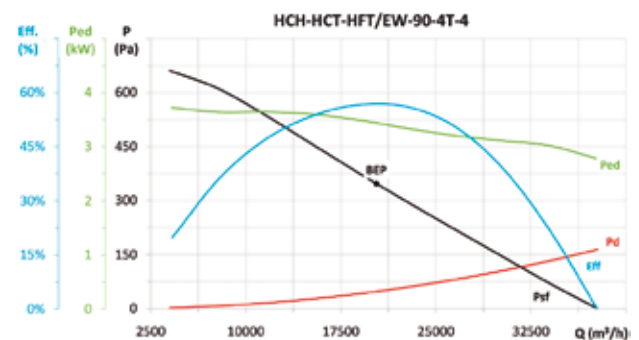

MC	EC	SR	Cc	η_e (%)*	N	[kW]	[m³/h]	[Pa]	[rpm]	VSD
A	S	1,00	1,05	59,7%	62,7	3,438	20308	346,8	1443	NECESSARY

* η_e (%) = Eff. (%) x Cc

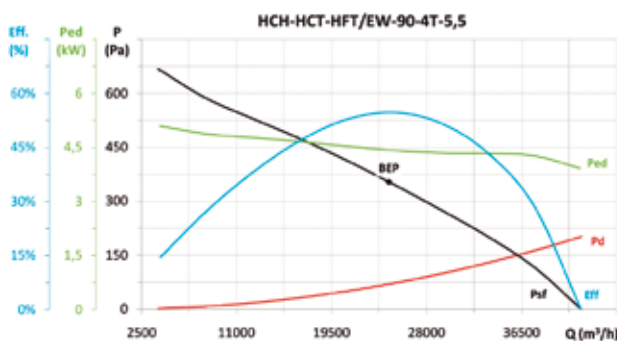

MC	EC	SR	Cc	η_e (%)*	N	[kW]	[m³/h]	[Pa]	[rpm]	VSD
A	S	1,00	1,04	57,0%	59,3	4,425	24635	353,7	1453	NECESSARY

* η_e (%) = Eff. (%) x Cc

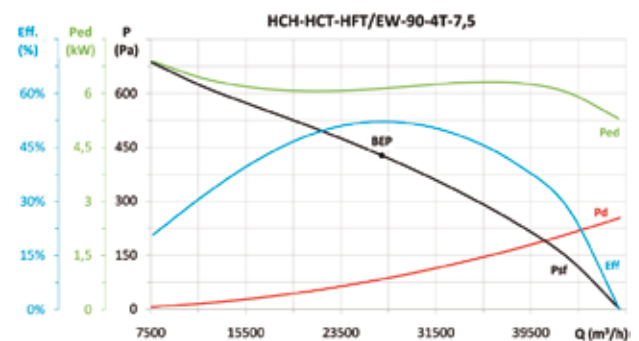

MC	EC	SR	Cc	η_e (%)*	N	[kW]	[m³/h]	[Pa]	[rpm]	VSD
A	S	1,01	1,04	54,2%	55,6	6,132	26945	427,3	1466	NECESSARY

* η_e (%) = Eff. (%) x Cc



EFFICIENT WORK



Erp. Characteristic curves and ErP data

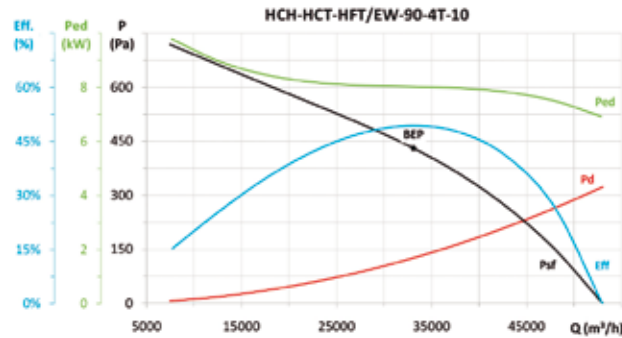

MC	EC	SR	Cc	η_e (%)*	N	[kW]	[m³/h]	[Pa]	[rpm]	VSD
A	S	1,01	1,04	51,3%	51,9	8,025	33102	430,6	1467	NECESSARY

* η_e (%) = Eff. (%) x Cc

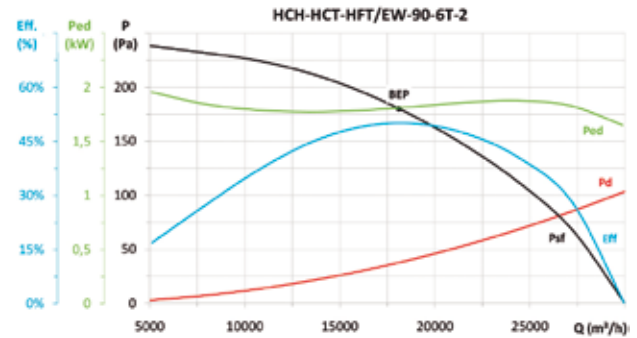

MC	EC	SR	Cc	η_e (%)*	N	[kW]	[m³/h]	[Pa]	[rpm]	VSD
A	S	1,00	1,07	53,5%	58,3	1,810	18106	180,2	953	NECESSARY

* η_e (%) = Eff. (%) x Cc

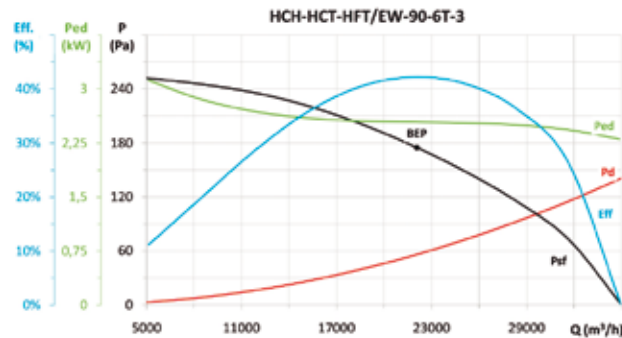

MC	EC	SR	Cc	η_e (%)*	N	[kW]	[m³/h]	[Pa]	[rpm]	VSD
A	S	1,00	1,06	44,7%	48,5	2,539	22079	174,8	954	NECESSARY

* η_e (%) = Eff. (%) x Cc

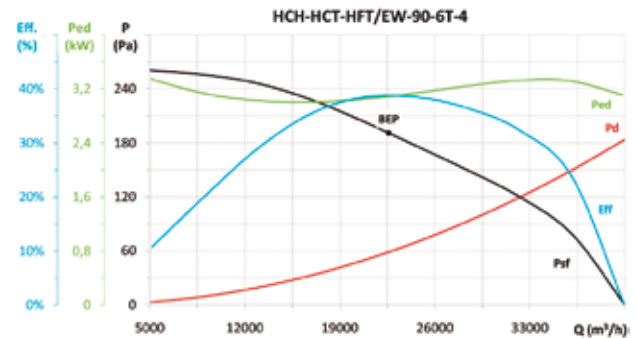

MC	EC	SR	Cc	η_e (%)*	N	[kW]	[m³/h]	[Pa]	[rpm]	VSD
A	S	1,00	1,05	40,9%	44,1	3,087	22590	191,0	974	NECESSARY

* η_e (%) = Eff. (%) x Cc

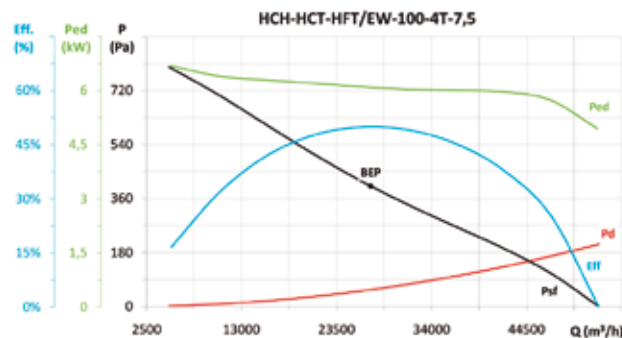

MC	EC	SR	Cc	η_e (%)*	N	[kW]	[m³/h]	[Pa]	[rpm]	VSD
A	S	1,00	1,04	51,9%	53,3	6,092	27281	401,7	1467	NECESSARY

* η_e (%) = Eff. (%) x Cc

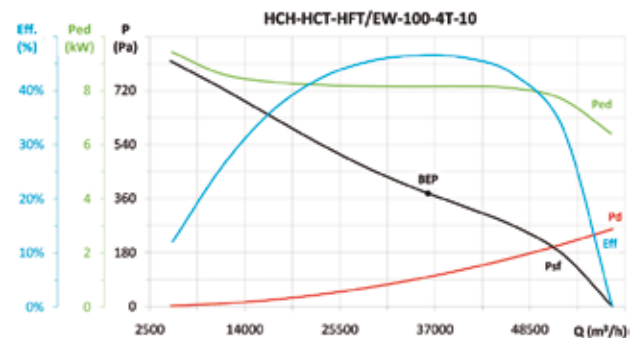

MC	EC	SR	Cc	η_e (%)*	N	[kW]	[m³/h]	[Pa]	[rpm]	VSD
A	S	1,00	1,04	48,4%	49,0	8,145	36164	377,5	1467	NECESSARY

* η_e (%) = Eff. (%) x Cc

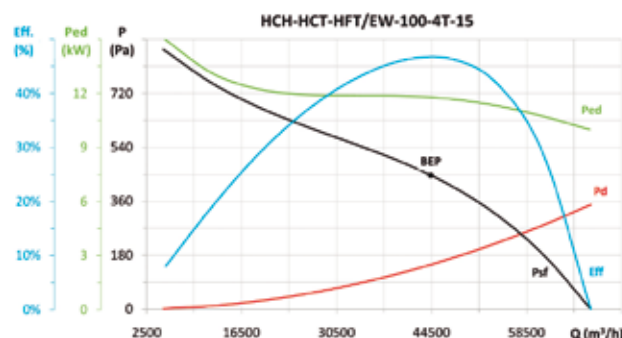

MC	EC	SR	Cc	η_e (%)*	N	[kW]	[m³/h]	[Pa]	[rpm]	VSD
A	S	1,01	1,04	48,6%	48,5	11,781	44388	446,6	1472	NECESSARY

* η_e (%) = Eff. (%) x Cc

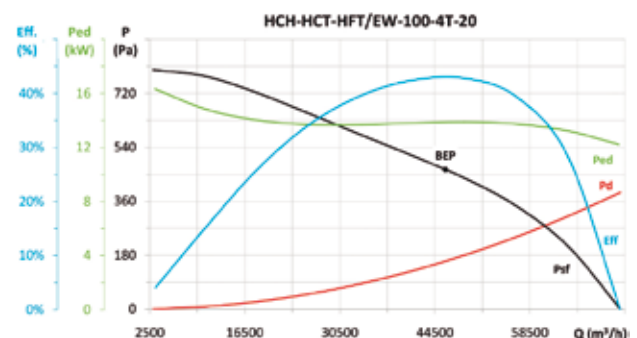

MC	EC	SR	Cc	η_e (%)*	N	[kW]	[m³/h]	[Pa]	[rpm]	VSD
A	S	1,01	1,04	44,7%	44,5	13,862	46050	465,9	1472	NECESSARY

* η_e (%) = Eff. (%) x Cc



Erp. Characteristic curves and ErP data

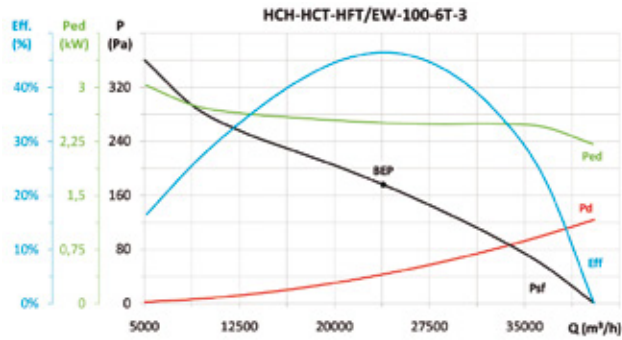

MC	EC	SR	Cc	η_e (%)*	N	[kW]	[m³/h]	[Pa]	[rpm]	VSD
A	S	1,00	1,06	49,2%	53,0	2,508	23849	175,8	954	NECESSARY

* η_e (%) = Eff. (%) x Cc

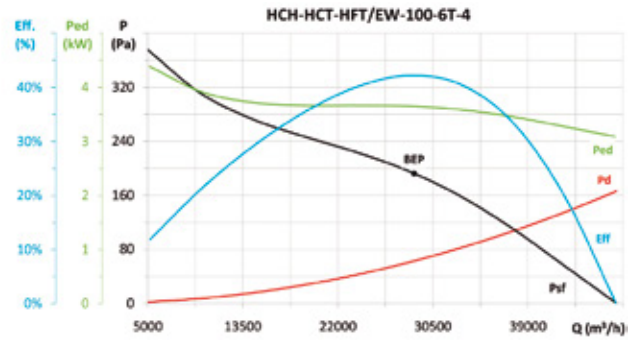

MC	EC	SR	Cc	η_e (%)*	N	[kW]	[m³/h]	[Pa]	[rpm]	VSD
A	S	1,00	1,05	44,2%	47,0	3,650	28826	192,4	970	NECESSARY

* η_e (%) = Eff. (%) x Cc

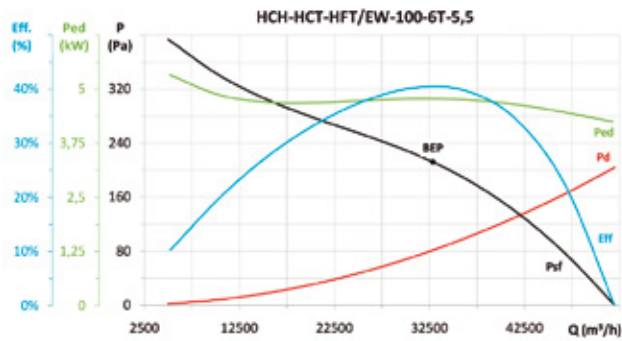

MC	EC	SR	Cc	η_e (%)*	N	[kW]	[m³/h]	[Pa]	[rpm]	VSD
A	S	1,00	1,04	42,1%	44,1	4,780	32856	212,0	961	NECESSARY

* η_e (%) = Eff. (%) x Cc

Accessories

See accessories section.

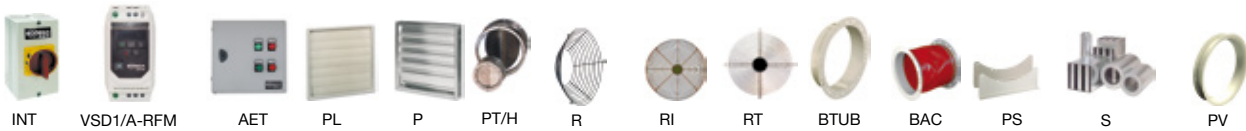

INT VSD1/A-RFM
VSD3/A-RFT



CONTROL UNITS
AND SENSORS



EFFICIENT WORK



CBD/EW CBD/B/EW



INDUSTRIAL
BRUSHLESS
MOTOR E.C.



VARIABLE SPEED DRIVE
VSD: Variable Speed Drive.
- VSD1/B
- VSD3/B

Supply included with fan

CONTROL
Supply optional accessory

SUPPLY
VSD1/B:
220-240 V 50/60 Hz
VSD3/B:
380-415 V 50/60 Hz

High-efficiency double-inlet centrifugal fans with a direct motor and impeller with forward-facing blades fitted with industrial BRUSHLESS motor E.C.

Fan:

- Galvanized sheet steel casing.
- Impeller with forward-facing blades made from galvanised sheet steel.
- They are supplied with PSB base stands.
- Electronic variable speed (VSD), three-phase or single-phase, is supplied with fan.

Motor and electronic variable speed:

- High-efficiency Industrial Brushless Motors E.C., fitted with electronic variable speed (VSD), adjustable via external control input 0-10V.
- It is advisable to install an electronic variable speed drive (VSD) outside the working area.
- The external signal can be supplied through a manual or automatic control with 0-10 V output.
- Electronic variable speed drive (VSD), available with single-phase 220-240 V 50/60 Hz input (VSD1/B type) or three-phase 380-415 V 50/60 Hz (VSD3/B

type).

- By default, the electronic variable speed drive (VSD) is delivered programmed for constant speed.
- Working fan temperature:
-25 °C +60 °C.
- Working temperature (VSD):
-25 °C +50 °C.

Finish:

- Anticorrosive galvanized sheet steel

Order code with variable speed drive (VSD) included

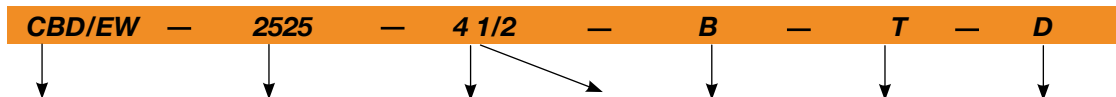

CBD/EW: High-efficiency double-inlet centrifugal fans with direct motor and impeller with forward-facing blades, "Efficient work"
CBD/B/EW: High efficiency double-inlet centrifugal fans, "Efficient work", with outlet flange and no support stand

Impeller size
mm. inches
1919 7/7
2525 9/9
2828 10/10
3333 12/12

Number of poles:
4=1410 r/min
6=960 r/min

Motor power (C.V.)

Industrial Brushless Motors E.C.

M: Fitted with VSD1/B, electronic variable speed, single phase power supply 220-240 V 50/60 Hz.

T: Fitted with VSD3/B, electronic variable speed, three-phase power supply 380-415 V 50/60 Hz.

D: Standard version, VSD supplied programmed for constant speed.
P: Supplied with VSD programmed for pressure control and Si-Presión pressure transmitter
K: Supplied with VSD programmed for pressure control and built into a BOXPRES KIT/B box.

Technical characteristics

Model	Speed min/max (r/min)	Equivalent in inches	Single-phase VSD 230 V 50/60 Hz		Three-phase VSD 400 V 50/60 Hz		Maximum electrical power (W)	Maximum airflow min/max (m³/h)	Sound pressure level min/max dB(A)	Weight approx. (Kg)
			Maximum current input (A)	Model VSD	Maximum current input (A)	Model VSD				
CBD/EW-1919-4 1/5	300 / 1410	7/7	2.13	VSD1/B-0.37	0.62	VSD3/B-0.75	260	325 / 1520	25 / 59	7.0
CBD/EW-1919-6 1/10	300 / 960	7/7	1.17	VSD1/B-0.37	0.34	VSD3/B-0.75	140	385 / 1230	28 / 53	7.0
CBD/EW-2525-4 1/2	300 / 1410	9/9	3.96	VSD1/B-0.37	0.93	VSD3/B-0.75	450	595 / 2800	32 / 66	13.2
CBD/EW-2525-4 1	300 / 1410	9/9	7.94	VSD1/B-0.75	1.87	VSD3/B-1.5	905	765 / 3600	36 / 70	14.0
CBD/EW-2525-6 1/3	300 / 960	9/9	2.93	VSD1/B-0.37	0.68	VSD3/B-0.75	330	845 / 2700	37 / 62	12.7
CBD/EW-2828-4 1/2	300 / 1410	10/10	3.96	VSD1/B-0.37	0.93	VSD3/B-0.75	450	595 / 2800	31 / 65	15.7
CBD/EW-2828-4 1	300 / 1410	10/10	7.94	VSD1/B-0.75	1.87	VSD3/B-1.5	905	840 / 3950	36 / 70	16.5
CBD/EW-2828-6 1/3	300 / 960	10/10	2.93	VSD1/B-0.37	0.68	VSD3/B-0.75	330	1000 / 3200	37 / 62	15.2
CBD/EW-3333-6 1	300 / 960	12/12	8.32	VSD1/B-1.5	1.96	VSD3/B-1.5	955	1875 / 6000	46 / 71	24.0
CBD/EW-3333-6 1 1/2	300 / 960	12/12	11.51	VSD1/B-1.5	2.71	VSD3/B-1.5	1325	2440 / 7800	50 / 75	24.5

Acoustic features at maximum speed

The specified values are determined according to free field measurements of sound levels in dB(A) at an equivalent distance of twice the fan's span plus the impeller's diameter, with a minimum of 1.5 m.

Sound power Lw(A) spectrum in dB(A) via frequency band in Hz.

Model	63	125	250	500	1000	2000	4000	8000	Model	63	125	250	500	1000	2000	4000	8000
CBD/EW-1919-4_1/5	29	44	55	63	65	64	63	55	CBD/EW-2828-4_1/2	35	50	61	69	71	70	69	61
CBD/EW-1919-6_1/10	23	38	49	57	59	58	57	49	CBD/EW-2828-4_1	40	55	66	74	76	75	74	66
CBD/EW-2525-4_1/2	36	51	62	70	72	71	70	62	CBD/EW-2828-6_1/3	32	47	58	66	68	67	66	58
CBD/EW-2525-4_3/4	40	55	66	74	76	75	74	66	CBD/EW-3333-6_1	41	56	67	75	77	76	75	67
CBD/EW-2525-6_1/3	32	47	58	66	68	67	66	58	CBD/EW-3333-6_1 1/2	45	60	71	79	81	80	79	71

Dimensions in mm

CBD- 1919...3333

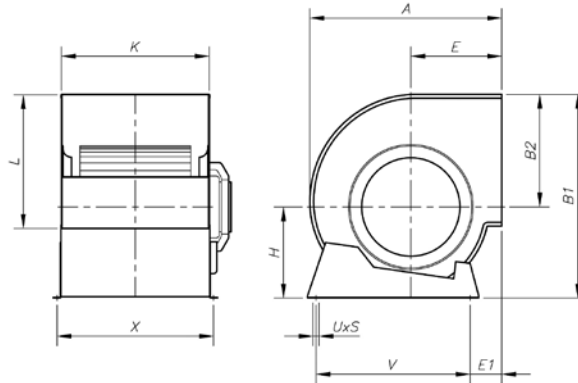

Model	Equiv. in inches	A	B1	B2	E	E1	G	H	K	L	UxS	V	X	x1	x2
CBD/EW-1919	7/7	315	333	189	152	64	-	144	230	208	9x13	225	258	-	-
CBD/EW-2525	9/9	380	400	218	183	78	-	182	300	263	9x13	275	328	-	-
CBD/EW-2828	10/10	422	450	246	202	73	-	204	326	292	9x17	315	355	-	-
CBD/EW-3333	12/12	493	526	290	230	82	-	236	387	345	9x17	390	415	-	-

CBD/B/EW

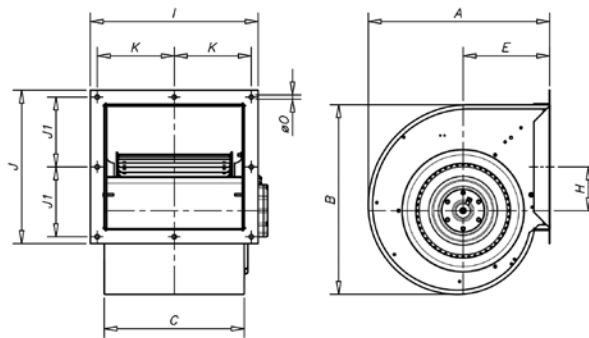

Model	Equiv. Inches	A	B	C	E	H	I	J	J1	K	K1	L	øO
CBD/B/EW-1919	7/7	315	322	230	152	86.5	295	273	120.5	131.5	-	-	10
CBD/B/EW-2525	9/9	380	393	300	183	89	365	328	148	166.5	-	-	10
CBD/B/EW-2828	10/10	422	442	326	202	102	391	357	162.5	179.5	-	-	10
CBD/B/EW-3333	12/12	493	527	387	230	121	452	410	189	210	-	-	10



Erp. Characteristic curves and ErP data

See CBD/EW-CJBD/EW model characteristic curves

Accessories

See accessories section.



INT



PSB



CONTROL UNITS AND SENSORS



EFFICIENT WORK



CJBD/EW CJBD/EW/AL



INDUSTRIAL
BRUSHLESS
MOTOR E.C.



CJBD/EW



CJBD/EW/AL



VARIABLE SPEED DRIVE
VSD: Variable Speed Drive.
- VSD1/B
- VSD3/B

Supply included with fan

CONTROL
Supply optional accessory

SUPPLY
VSD1/B:
220-240 V 50/60 Hz
VSD3/B:
380-415 V 50/60 Hz

CJBD/EW: Soundproofed ventilation units fitted with CBD/EW fans with industrial BRUSHLESS motor E.C.

CJBD/EW/AL: Soundproofed ventilation units with aluminium profiles and pre-lacquered sheet with CBD/EW fans with industrial BRUSHLESS motor E.C.

Fan:

- Galvanized sheet steel casing.
- Impeller with forward-facing blades made from galvanised sheet steel
- They are supplied with PSB base stands.
- Electronic variable speed (VSD), three-phase or single-phase, is supplied with fan.

Motor and electronic variable speed:

- High-efficiency Industrial Brushless Motors E.C., fitted with electronic variable speed (VSD), adjustable via external control input 0-10V.
- It is advisable to install an electronic variable speed drive (VSD) outside the working area.
- The external signal can be supplied through a manual or automatic control with 0-10 V output.
- Electronic variable speed drive (VSD), available with single-phase 220-240 V 50/60 Hz input (VSD1/B type) or three-phase 380-415 V 50/60 Hz (VSD3/B type).
- By default, the electronic variable speed drive

(VSD) is delivered programmed for constant speed.

- Working fan temperature: -25 °C +60 °C.
- Working temperature (VSD): -25 °C +50 °C.

Finish:

- Anticorrosive galvanized sheet steel

Order code with variable speed drive (VSD) included

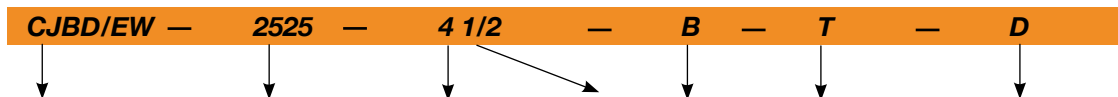

CJBD/EW: Soundproofed high-efficiency filtration units, "Efficient work"

CJBD/EW/AL: Soundproofed high-efficiency filtration units, "Efficient work", with aluminium profiles and pre-lacquered sheet

CJBD/EW/C: Soundproofed high-efficiency filtration units, "Efficient work", with circular inlet/outlet

CJBD/EW/F: Soundproofed high-efficiency filtration units, "Efficient work", with built-in filters

CJBD/EW/ALS: Soundproofed high-efficiency filtration units, "Efficient work", with double wall of insulation and pre-lacquered sheet

CJBD/EW/ALF: Soundproofed high-efficiency filtration units, "Efficient work", with pre-lacquered sheet and built-in filters

Impeller size	mm.	inches
1919	7/7	
2525	9/9	
2828	10/10	
3333	12/12	

Number of poles:	r/min
4=1410	
6=960	

Motor power (C.V.)	Industrial Brushless Motors E.C.
	M: Fitted with VSD1/B, electronic variable speed, single phase power supply 220-240 V 50/60 Hz.
	T: Fitted with VSD3/B, electronic variable speed, three-phase power supply 380-415 V 50/60 Hz.

D: Standard version, VSD supplied programmed for constant speed.	P: Supplied with VSD programmed for pressure control and Si-Presión pressure transmitter	K: Supplied with VSD programmed for pressure control and built into a BOXPRES KIT/B box.
--	--	--

Options



CJBD/C/EW



CJBD/F/EW



CJBD/ALS/EW



CJBD/ALF/EW

Technical characteristics

Model	Speed min/max (r/min)	Equivalent in inches	Single-phase VSD 230 V 50/60 Hz Maximum current input (A)	Model VSD	Three-phase VSD 400 V 50/60 Hz Maximum current input (A)	Model VSD	Maximum electrical power (W)	Maximum airflow min/max (m³/h)	Sound pressure level min/max dB(A)	Weight approx. (Kg)
CJBD/EW CJBD/EW/AL 1919-4 1/5	300 / 1410	7/7	2.13	VSD1/B-0.37	0.62	VSD3/B-0.75	260	325 / 1520	25 / 59	7.0
CJBD/EW CJBD/EW/AL 1919-6 1/10	300 / 960	7/7	1.17	VSD1/B-0.37	0.34	VSD3/B-0.75	140	385 / 1230	28 / 53	7.0
CJBD/EW CJBD/EW/AL 2525-4 1/2	300 / 1410	9/9	3.96	VSD1/B-0.37	0.93	VSD3/B-0.75	450	595 / 2800	32 / 66	13.2
CJBD/EW CJBD/EW/AL 2525-4 1	300 / 1410	9/9	7.94	VSD1/B-0.75	1.87	VSD3/B-1.5	905	765 / 3600	36 / 70	14.0
CJBD/EW CJBD/EW/AL 2525-6 1/3	300 / 960	9/9	2.93	VSD1/B-0.37	0.68	VSD3/B-0.75	330	845 / 2700	37 / 62	12.7
CJBD/EW CJBD/EW/AL 2828-4 1/2	300 / 1410	10/10	3.96	VSD1/B-0.37	0.93	VSD3/B-0.75	450	595 / 2800	31 / 65	15.7
CJBD/EW CJBD/EW/AL 2828-4 1	300 / 1410	10/10	7.94	VSD1/B-0.75	1.87	VSD3/B-1.5	905	840 / 3950	36 / 70	16.5
CJBD/EW CJBD/EW/AL 2828-6 1/3	300 / 960	10/10	2.93	VSD1/B-0.37	0.68	VSD3/B-0.75	330	1000 / 3200	37 / 62	15.2
CJBD/EW CJBD/EW/AL 3333-6 1	300 / 960	12/12	8.32	VSD1/B-1.5	1.96	VSD3/B-1.5	955	1875 / 6000	46 / 71	24.0
CJBD/EW CJBD/EW/AL 3333-6 1 1/2	300 / 960	12/12	11.51	VSD1/B-1.5	2.71	VSD3/B-1.5	1325	2440 / 7800	50 / 75	24.5

Acoustic features at maximum speed

The specified values are determined according to free field measurements of sound levels in dB(A) at an equivalent distance of twice the fan's span plus the impeller's diameter, with a minimum of 1.5 m.

Sound power Lw(A) spectrum in dB(A) via frequency band in Hz.

Model	63	125	250	500	1000	2000	4000	8000	Model	63	125	250	500	1000	2000	4000	8000
1919-4 1/5	43	54	58	62	64	63	62	53	2828-4 1/2	50	61	65	69	71	70	69	60
1919-6 1/10	38	49	53	57	59	58	57	48	2828-4 1	55	66	70	74	76	75	74	65
2525-4 1/2	51	62	66	70	72	71	70	61	2828-6 1/3	46	57	61	65	67	66	65	56
2525-4 1	55	66	70	74	76	75	74	65	3333-6 1	55	66	70	74	76	75	74	65
2525-6 1/3	46	57	61	65	67	66	65	56	3333-6 1 1/2	59	70	74	78	80	79	78	69

Dimensions in mm

CJBD/EW
CJBD/EW/F

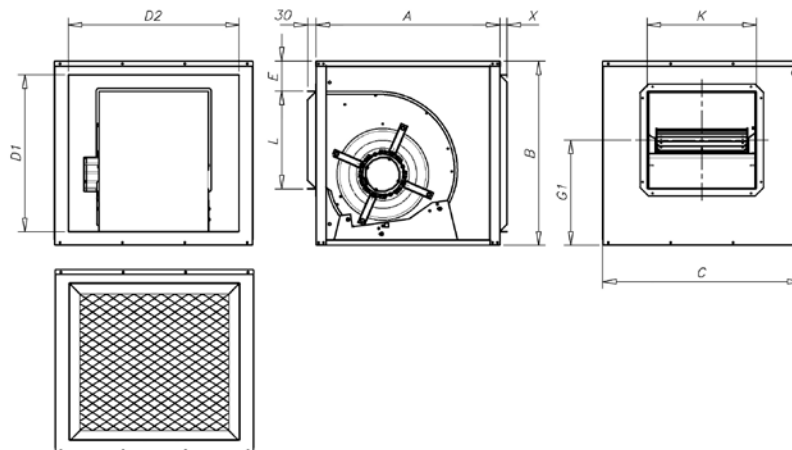

Size	A	B	C	E	D1	D2	G1	L	K	X	X
CJBD/EW-1919	7/7	450	460	500	110	370	410	245	210	232	25 30
CJBD/EW-2525	9/9	500	522	550	107	426	454	283.5	263	300	25 30
CJBD/EW-2828	10/10	550	575	600	105.5	479	504	324.5	292	326	25 30
CJBD/EW-3333	12/12	650	650	700	106	554	604	372.5	345	387	25 30

Accessories

See accessories section.

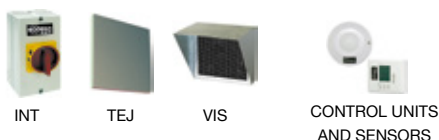



EFFICIENT WORK



Dimensions in mm

Dimensions in mm

Abmessungen in mm

Dimensions mm

CJBD/EW/C

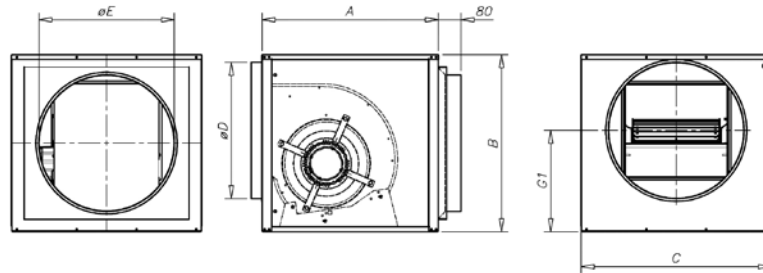

Model	Equiv. in inches	A	B	C	øD	D1	øE	D2	G1
CJBD/EW/C-1919	7/7	450	460	500	250	370	250	410	245
CJBD/EW/C-2525	9/9	500	522	550	355	426	355	454	283.5
CJBD/EW/C-2828	10/10	550	575	600	400	479	400	504	324.5
CJBD/EW/C-3333	12/12	650	650	700	500	554	500	604	372.5

**CJBD/EW/AL
CJBD/EW/ALS
CJBD/EW/ALF**

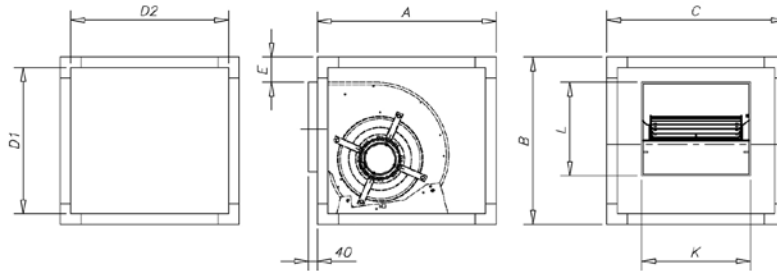

Model	Size	A	B	C	D1	D2	E	L	K
CJBD/EW/AL-1919	7/7	460	460	460	420	420	88	202	225
CJBD/EW/AL-2525	9/9	520	520	520	480	480	110	265	295
CJBD/EW/AL-2828	10/10	575	575	575	535	535	122	286	322
CJBD/EW/AL-3333	12/12	650	650	650	610	610	108	339	384

Characteristic curves

See CBD/EW-CJBD/EW characteristic curves

Characteristic load loss curves for units with filter

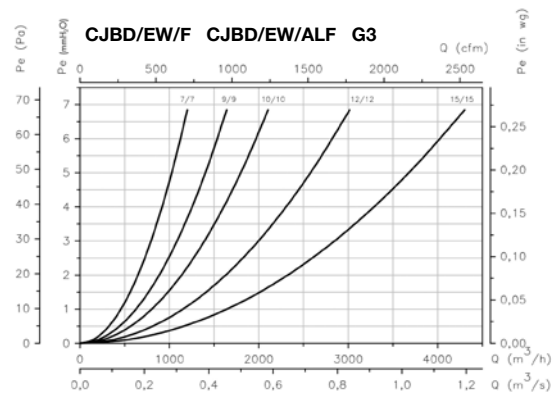
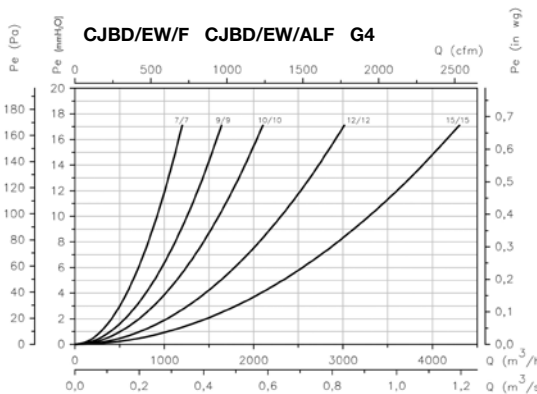



Erp. Characteristic curves and ErP data

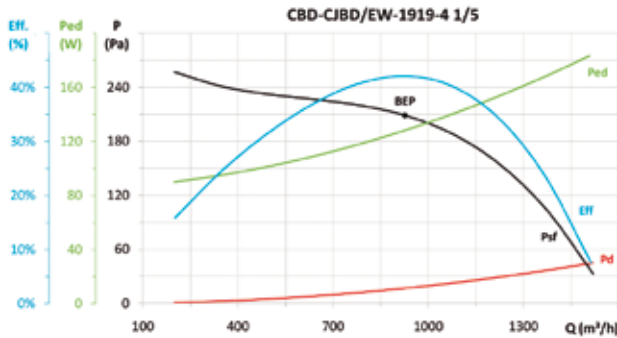

MC	EC	SR	Cc	η_a (%)*	N	[kW]	[m³/h]	[Pa]	[rpm]	VSD
A	S	1,00	1,15	48,4%	60,3	0,128	926	208,7	1410	INCLUDED

* η_e (%) = Eff. (%) x Cc

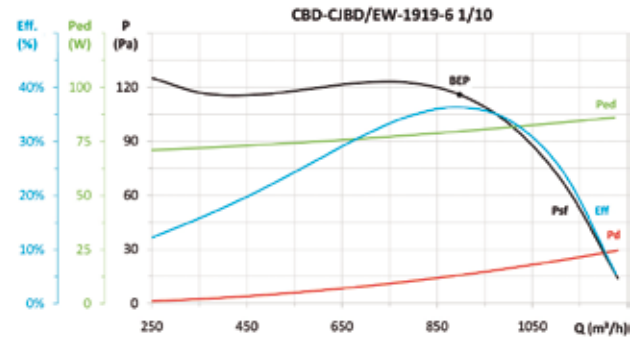

MC	EC	SR	Cc	η_a (%)*	N	[kW]	[m³/h]	[Pa]	[rpm]	VSD
A	S	-	-	-	-	0,080	897	115,9	960	INCLUDED

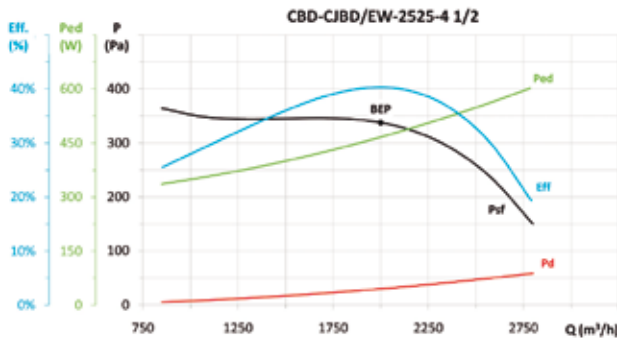

MC	EC	SR	Cc	η_a (%)*	N	[kW]	[m³/h]	[Pa]	[rpm]	VSD
A	S	1,00	1,11	44,8%	53,2	0,465	2000	337,4	1410	INCLUDED

* η_e (%) = Eff. (%) x Cc

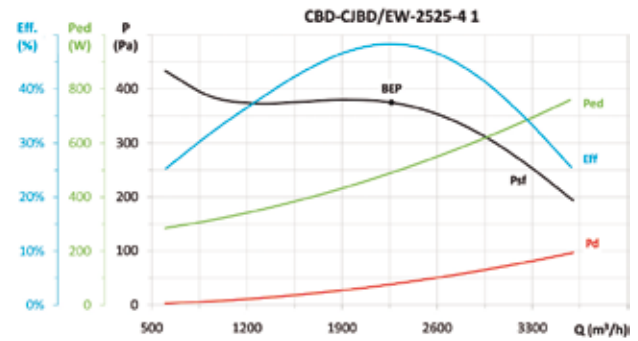

MC	EC	SR	Cc	η_a (%)*	N	[kW]	[m³/h]	[Pa]	[rpm]	VSD
A	S	1,00	1,11	53,6%	61,9	0,488	2265	374,7	1410	INCLUDED

* η_e (%) = Eff. (%) x Cc

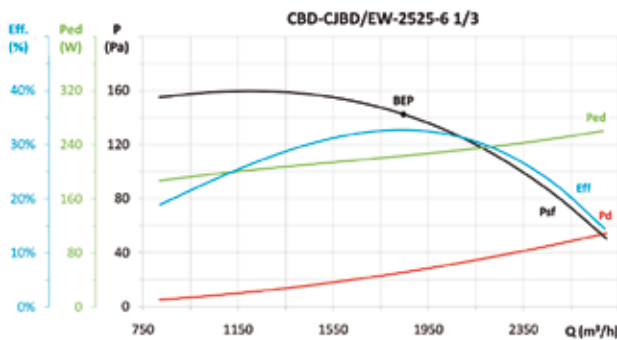

MC	EC	SR	Cc	η_a (%)*	N	[kW]	[m³/h]	[Pa]	[rpm]	VSD
A	S	1,00	1,13	37,1%	47,5	0,223	1846	142,5	960	INCLUDED

* η_e (%) = Eff. (%) x Cc

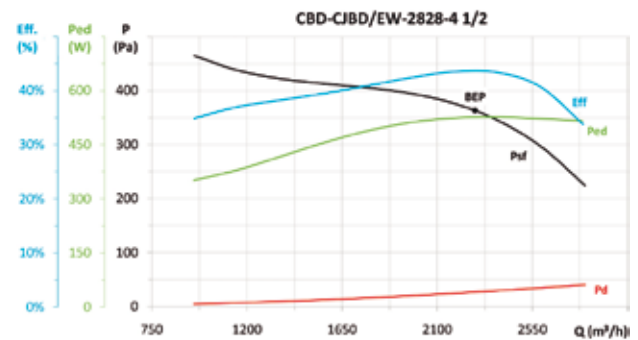

MC	EC	SR	Cc	η_a (%)*	N	[kW]	[m³/h]	[Pa]	[rpm]	VSD
A	S	1,00	1,11	48,3%	56,4	0,527	2279	363,1	1410	INCLUDED

* η_e (%) = Eff. (%) x Cc

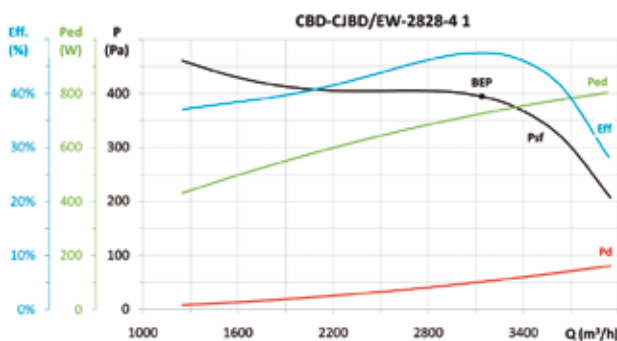

MC	EC	SR	Cc	η_a (%)*	N	[kW]	[m³/h]	[Pa]	[rpm]	VSD
A	S	1,00	1,10	52,1%	59,4	0,723	3138	394,1	1410	INCLUDED

* η_e (%) = Eff. (%) x Cc

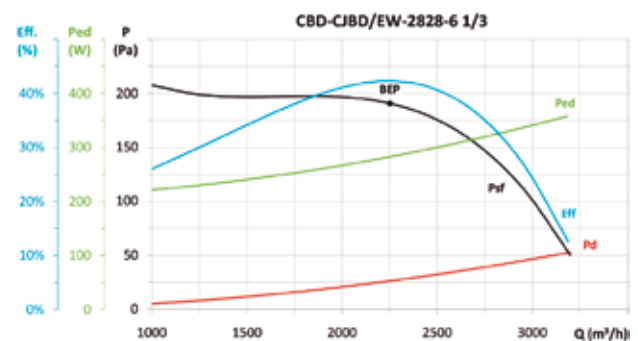

MC	EC	SR	Cc	η_a (%)*	N	[kW]	[m³/h]	[Pa]	[rpm]	VSD
A	S	1,00	1,13	47,6%	57,4	0,282	2251	190,6	960	INCLUDED

* η_e (%) = Eff. (%) x Cc



EFFICIENT WORK



Erp. Characteristic curves and ErP data

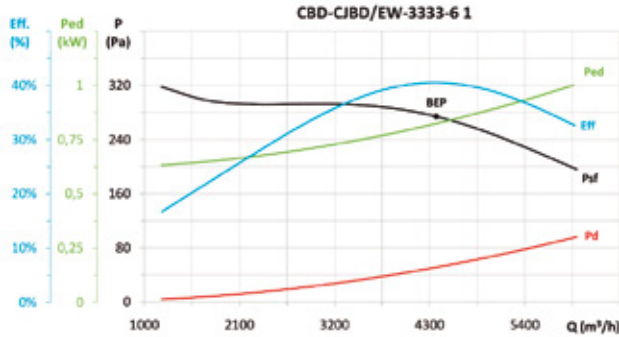

MC	EC	SR	Cc	η_e (%)*	N	[kW]	[m³/h]	[Pa]	[rpm]	VSD
A	S	1,00	1,09	44,3%	51,2	0,822	4377	274,1	960	INCLUDED

* η_e (%) = Eff. (%) x Cc

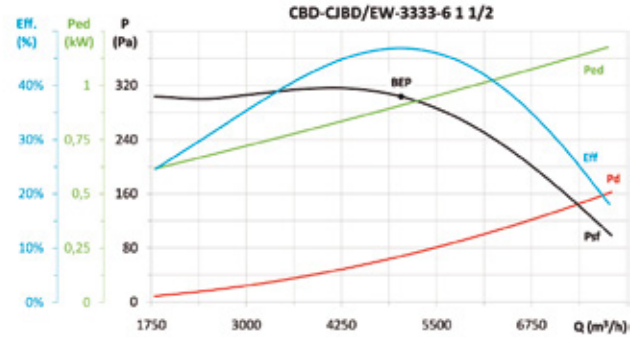

MC	EC	SR	Cc	η_e (%)*	N	[kW]	[m³/h]	[Pa]	[rpm]	VSD
A	S	1,00	1,09	51,1%	57,7	0,906	5035	303,7	960	INCLUDED

* η_e (%) = Eff. (%) x Cc

CMA/EW



VARIABLE SPEED DRIVE
VSD: Variable Speed Drive.
- VSD1/B
- VSD3/B

Supply included with fan

CONTROL
Supply optional accessory

SUPPLY
VSD1/B:
220-240 V 50/60 Hz
VSD3/B:
380-415 V 50/60 Hz

Centrifugal single-inlet, medium-pressure fans with casing and impeller made from cast aluminium fitted with industrial BRUSHLESS motor E.C.

Fan:

- Casing made from cast aluminium.
- Impeller made from cast aluminium.
- Models 324, 325 and 426 with polyamide impeller, sheet steel model 531-2T-3.
- Electronic variable speed drive (VSD), three-phase or single-phase, is supplied with fan.

Motor and electronic variable speed:

- High-efficiency Industrial Brushless Motors E.C., fitted with electronic variable speed (VSD), adjustable via external control input 0-10V.
- It is advisable to install an electronic variable speed drive (VSD) outside the working area.
- The external signal can be supplied through a manual or automatic control with 0-10 V output.
- Electronic variable speed drive (VSD), available with single-phase 220-240 V 50/60 Hz input (VSD1/B type) or three-phase 380-415 V 50/60 Hz (VSD3/B type).
- By default, the electronic variable speed drive (VSD) is delivered programmed for constant speed.

Working fan temperature:

- -25 °C +120 °C.
- Working temperature (VSD): -25 °C +50 °C.

Finish:

- Anticorrosive finish in polyester resin polymerised at 190°C, after alkaline degreasing with nanotechnology treatment and phosphate-free.

On request:

- Cast aluminium impellers for models 324, 325 and 426.

Order code with variable speed drive (VSD) included

CMA/EW — 531 — 2 — 1,5 — B — T — D

CMA/EW: High-efficiency centrifugal single-inlet, medium-pressure fans with casing and impeller made from cast aluminium, "Efficient work"

Impeller size

Number of poles:
2=2850 r/min

Motor power (CV)

Industrial Brushless Motors E.C.

M: Fitted with VSD1/B, electronic variable speed, single phase power supply 220-240 V 50/60 Hz.

T: Fitted with VSD3/B, electronic variable speed, three-phase power supply 380-415 V 50/60 Hz.

D: Standard version, VSD supplied programmed for constant speed.
P: Supplied with VSD programmed for pressure control and Si-Presión pressure transmitter
K: Supplied with VSD programmed for pressure control and built into a BOXPRES KIT/B box.

Technical characteristics

Model	Speed min/max (r/min)	Single-phase VSD 230 V 50/60 Hz		Three-phase VSD 400 V 50/60 Hz		Maximum electrical power (W)	Maximum airflow min/max (m³/h)	Sound pressure level min/max dB(A)	Weight approx. (Kg)
		Maximum current input (A)	Model VSD	Maximum current input (A)	Model VSD				
CMA/EW-218-2	300 / 2850	2.09	VSD1/B-0.37	0.61	VSD3/B-0.75	255	30 / 265	14 / 63	6.0
CMA/EW-324-2	300 / 2850	2.09	VSD1/B-0.37	0.61	VSD3/B-0.75	255	45 / 440	21 / 70	9.0
CMA/EW-325-2	300 / 2850	2.86	VSD1/B-0.37	0.84	VSD3/B-0.75	345	65 / 600	24 / 73	11.0
CMA/EW-426-2	300 / 2850	4.08	VSD1/B-0.37	1.20	VSD3/B-0.75	495	90 / 850	26 / 75	13.0
CMA/EW-527-2	300 / 2850	5.99	VSD1/B-0.37	1.76	VSD3/B-0.75	730	105 / 1000	31 / 80	14.8
CMA/EW-528-2-1	300 / 2850	8.15	VSD1/B-0.75	1.92	VSD3/B-0.75	925	130 / 1250	33 / 82	23.5
CMA/EW-528-2-1.5	300 / 2850	11.80	VSD1/B-0.75	2.78	VSD3/B-1.5	1345	185 / 1750	34 / 83	26.0
CMA/EW-531-2-1.5	300 / 2850	11.80	VSD1/B-0.75	2.78	VSD3/B-1.5	1345	190 / 1790	35 / 84	29.0
CMA/EW-531-2-2	300 / 2850	15.89	VSD1/B-1.5	3.74	VSD3/B-1.5	1810	210 / 2000	36 / 85	31.0
CMA/EW-531-2-3	300 / 2850	23.11	VSD1/B-2.2	5.45	VSD3/B-2.2	2630	255 / 2400	37 / 86	30.0
CMA/EW-540-2	300 / 2850	15.89	VSD1/B-1.5	3.74	VSD3/B-1.5	1810	275 / 2600	36 / 85	38.0
CMA/EW-545-2-3	300 / 2850	23.11	VSD1/B-2.2	5.45	VSD3/B-2.2	2630	275 / 2630	37 / 86	54.0



EFFICIENT WORK



Acoustic features at maximum speed

The specified values are determined according to free field measurements of sound levels in dB(A) at an equivalent distance of twice the fan's span plus the impeller's diameter, with a minimum of 1.5 m.

Sound power Lw(A) spectrum in dB(A) via frequency band in Hz.

Model	63	125	250	500	1000	2000	4000	8000	Model	63	125	250	500	1000	2000	4000	8000
CMA/EW-218-2	29	43	61	67	71	68	63	54	CMA/EW-528-2-1.5	49	63	81	87	91	88	83	74
CMA/EW-324-2	36	50	68	74	78	75	70	61	CMA/EW-531-2-1.5	50	64	82	88	92	89	84	75
CMA/EW-325-2	39	53	71	77	81	78	73	64	CMA/EW-531-2-2	51	65	83	89	93	90	85	76
CMA/EW-426-2	41	55	73	79	83	80	75	66	CMA/EW-531-2-3	52	66	84	90	94	91	86	77
CMA/EW-527-2	46	60	78	84	88	85	80	71	CMA/EW-540-2	54	67	85	91	96	92	87	79
CMA/EW-528-2-1	48	62	80	86	90	87	82	73	CMA/EW-545-2-3	55	68	86	92	97	93	88	80

Dimensions in mm

CMA/EW-218...531

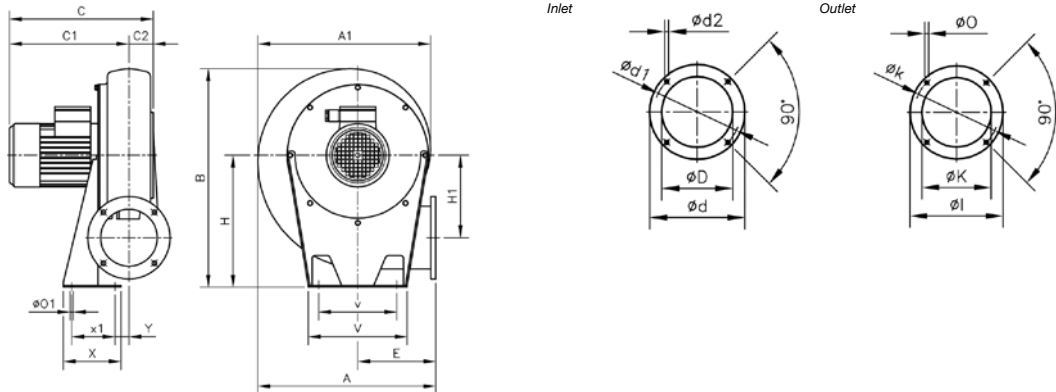

Model	A	A1	B	C	C1	C2	ØD	Ød	Ød1	Ød2	E	H	H1	Øl	ØK	Øk	Ø0	Ø01	V	v	X	x1	Y
CMA/EW-218-2	241	236	288	239	208	32	80	113	90	M5	110	170	114,5	90	54	76	5,5	7	140	100	80	50	20
CMA/EW-324-2	311	302	356	268	202	38	80	130	112	M5	145	205	145	108	62	90	7	9	173	125	90	60	20
CMA/EW-325-2	335	328	399	271	223	40	94	140	122	M6	155	235	152	120	80	102	7	9	180	145	110	80	20
CMA/EW-426-2	354	344	412	291	250	40	117	155	132	M6	162	240	163	140	90	119	7	13	210	160	105	65	26
CMA/EW-527-2	371	361	440	295	254	42	125	170	147	M6	168	260	170	155	100	129	7	13	220	170	120	80	20
CMA/EW-528-2-1	401	395	488	340	289	51	116	190	162	M6	178	290	177	190	130	160	11	13	230	180	140	100	20
CMA/EW-528-2-1.5	401	395	488	337	289	48	135	190	162	M6	178	290	177	190	130	160	11	13	230	180	140	100	20
CMA/EW-531-2-1.5	440	434	537	341	290	50	160	215	180	M6	193	320	200	200	140	175	11	13	240	190	160	120	21
CMA/EW-531-2-2	440	434	537	388	340	50	160	215	180	M6	193	320	200	200	140	175	11	13	240	190	160	120	21
CMA/EW-531-2-3	440	434	537	388	350	50	160	215	180	M6	193	320	200	200	140	175	11	13	240	190	160	120	21

CMA/EW-540-545

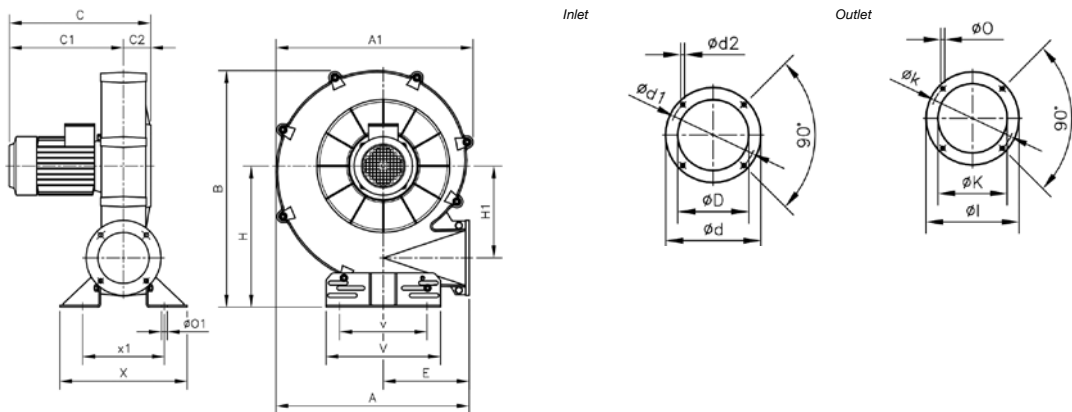

Model	A	A1	B	C	C1	C2	ØD	Ød	Ød1	Ød2	E	H	H1	Øl	ØK	Øk	Ø0	Ø01	V	v	X	x1
CMA/EW-540-2	567	580	695	375	320	80	170	240	205	M10	252	415	270	220	150	190	13	11	336	218	374	240
CMA/EW-545-2-3	651	646	776	423	344	115	180	255	220	M10	290	450	309	250	175	220	13	13	336	238	392	292

Positions

LG 270 standard supply. LG 180 position on request and with special fixing measures





Erp. Characteristic curves and ErP data

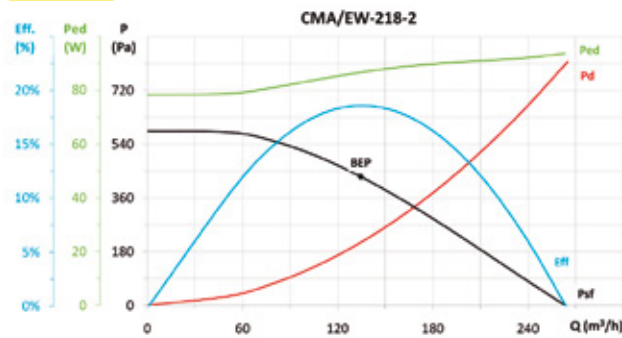

MC	EC	SR	Cc	η_a (%)*	N	[kW]	[m³/h]	[Pa]	[rpm]	VSD
A	S	-	-	-	-	0,087	135	431	2850	INCLUDED

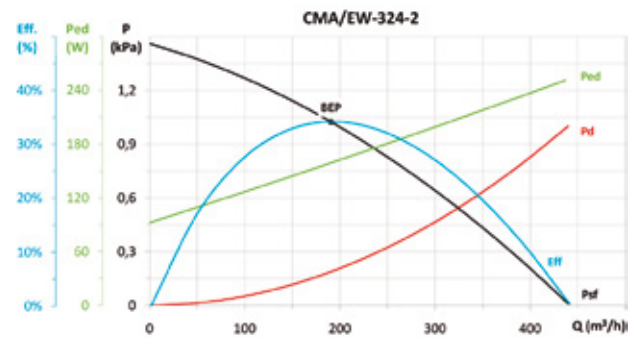

MC	EC	SR	Cc	η_a (%)*	N	[kW]	[m³/h]	[Pa]	[rpm]	VSD
A	S	1,01	1,14	39,1%	50,5	0,158	191	1024	2850	INCLUDED

* η_e (%) = Eff. (%) x Cc

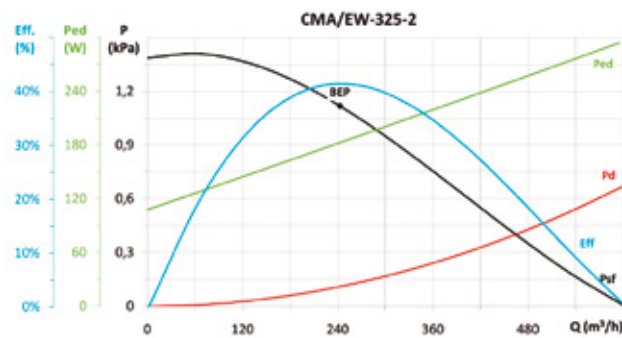

MC	EC	SR	Cc	η_a (%)*	N	[kW]	[m³/h]	[Pa]	[rpm]	VSD
A	S	1,01	1,14	47,2%	58,2	0,182	243	1118	2850	INCLUDED

* η_e (%) = Eff. (%) x Cc

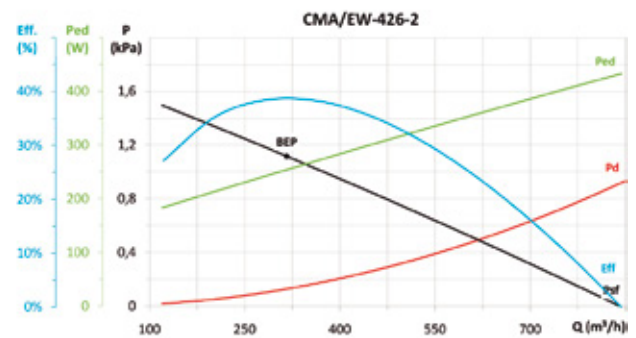

MC	EC	SR	Cc	η_a (%)*	N	[kW]	[m³/h]	[Pa]	[rpm]	VSD
A	S	1,01	1,13	43,7%	53,8	0,253	316	1117	2850	INCLUDED

* η_e (%) = Eff. (%) x Cc

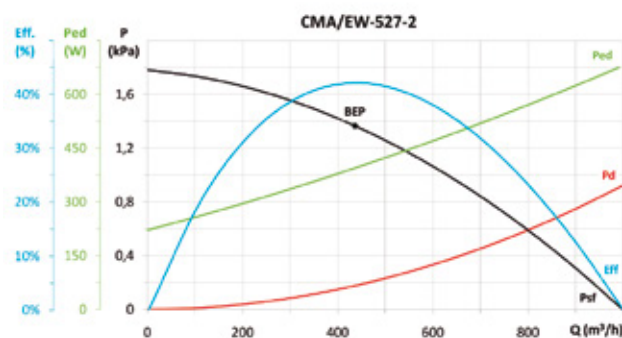

MC	EC	SR	Cc	η_a (%)*	N	[kW]	[m³/h]	[Pa]	[rpm]	VSD
A	S	1,02	1,12	47,0%	55,9	0,393	436	1365	2850	INCLUDED

* η_e (%) = Eff. (%) x Cc

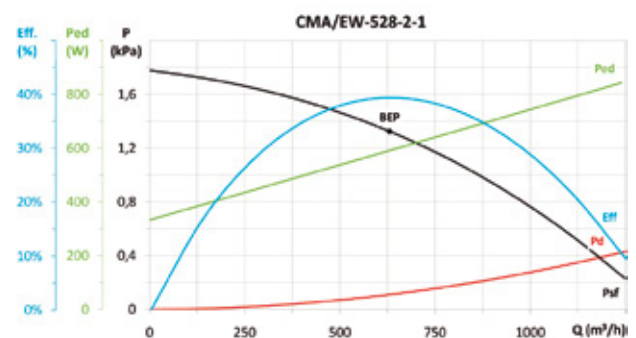

MC	EC	SR	Cc	η_a (%)*	N	[kW]	[m³/h]	[Pa]	[rpm]	VSD
A	S	1,01	1,10	43,5%	51,3	0,589	631	1324	2850	INCLUDED

* η_e (%) = Eff. (%) x Cc

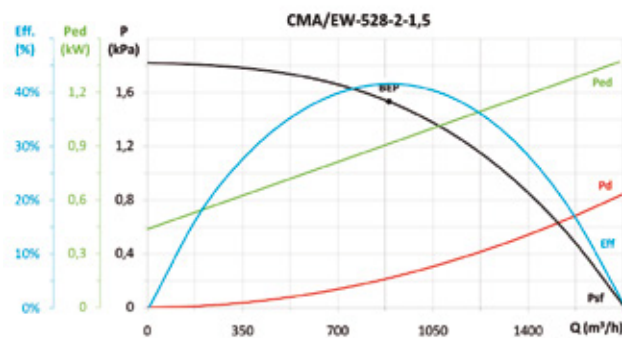

MC	EC	SR	Cc	η_a (%)*	N	[kW]	[m³/h]	[Pa]	[rpm]	VSD
A	S	1,02	1,09	45,3%	51,9	0,909	889	1530	2850	INCLUDED

* η_e (%) = Eff. (%) x Cc

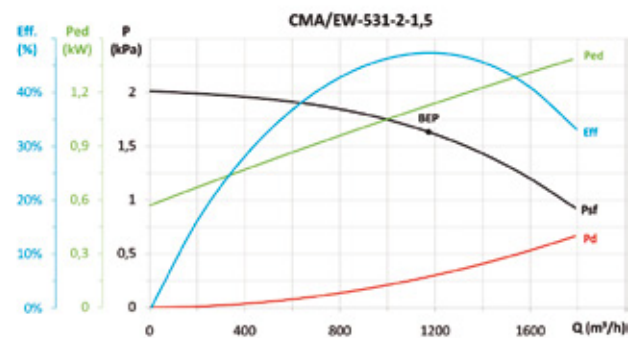

MC	EC	SR	Cc	η_a (%)*	N	[kW]	[m³/h]	[Pa]	[rpm]	VSD
A	S	1,02	1,08	51,3%	57,3	1,123	1173	1630	2850	INCLUDED

* η_e (%) = Eff. (%) x Cc



EFFICIENT WORK



Erp. Characteristic curves and ErP data

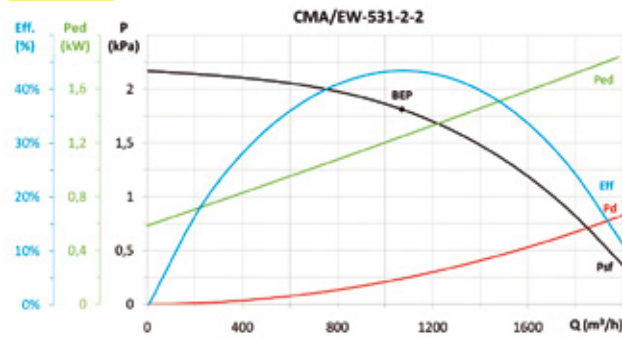

MC	EC	SR	Cc	η_e (%)*	N	[kW]	[m³/h]	[Pa]	[rpm]	VSD
A	S	1,02	1,08	46,9%	52,7	1,242	1071	1811	2850	INCLUDED

* η_e (%) = Eff. (%) x Cc

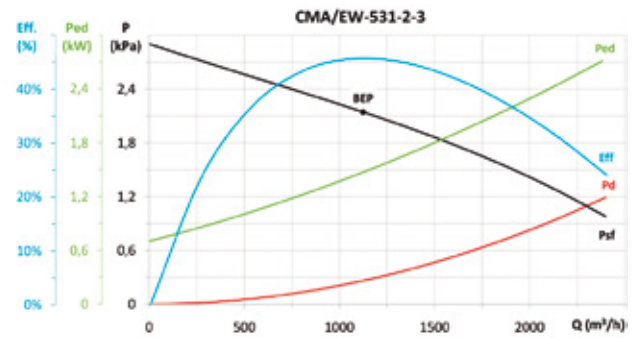

MC	EC	SR	Cc	η_e (%)*	N	[kW]	[m³/h]	[Pa]	[rpm]	VSD
A	S	1,02	1,08	49,2%	54,5	1,465	1125	2143	2850	INCLUDED

* η_e (%) = Eff. (%) x Cc

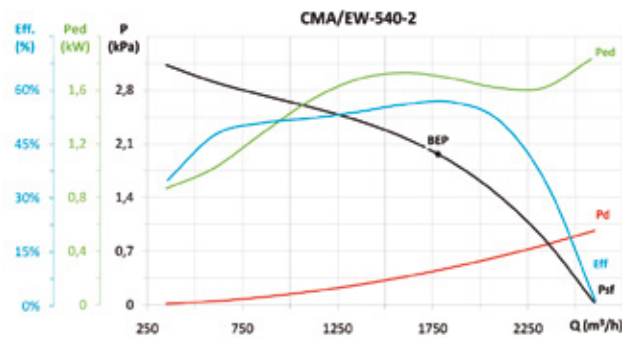

MC	EC	SR	Cc	η_e (%)*	N	[kW]	[m³/h]	[Pa]	[rpm]	VSD
A	S	1,02	1,07	60,9%	69,0	1,708	1778	1967	2850	INCLUDED

* η_e (%) = Eff. (%) x Cc

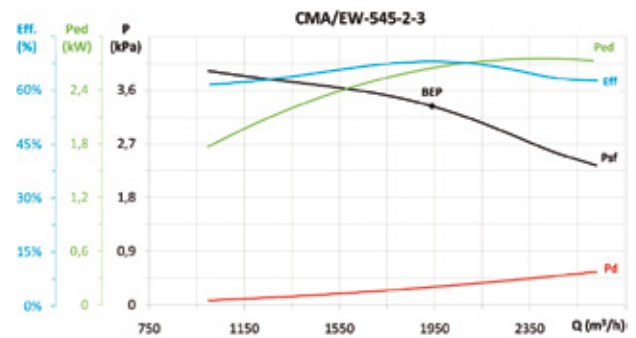

MC	EC	SR	Cc	η_e (%)*	N	[kW]	[m³/h]	[Pa]	[rpm]	VSD
A	S	1,04	1,06	72,0%	78,1	2,640	1939	3332	2850	INCLUDED

* η_e (%) = Eff. (%) x Cc

Accessories

See accessories section.



INT



RPA



B



ACE



S



REG



CONTROL UNITS AND SENSORS



CMP-L/EW

INDUSTRIAL BRUSHLESS MOTOR E.C.

VARIABLE SPEED DRIVE
 VSD: Variable Speed Drive
 . VSD1/B
 . VSD3/B
 Supply included with fan

CONTROL
 Supply optional accessory

SUPPLY
 VSD1/B:
 220-240 V 50/60 Hz
 VSD3/B:
 380-415 V 50/60 Hz

Centrifugal single-inlet, medium-pressure fans with direct motor and impeller with forward-facing blades fitted with industrial BRUSHLESS motor E.C.

Fan:

- Steel sheet casing
- Impeller with backward-curved blades made from robust sheet steel
- Electronic variable speed drive (VSD), three-phase or single-phase, is supplied with fan.

Motor and electronic variable speed:

- High-efficiency Industrial Brushless Motors E.C., fitted with electronic variable speed (VSD), adjustable via external control input 0-10V.
- It is advisable to install an electronic variable speed drive (VSD) outside the working area.
- The external signal can be supplied through a manual or automatic control with 0-10 V output.
- Electronic variable speed drive (VSD), available with single-phase 220-240 V 50/60 Hz input (VSD1/B type) or

three-phase 380-415 V 50/60 Hz (VSD3/B type).

- By default, the electronic variable speed drive (VSD) is delivered programmed for constant speed.
- Working fan temperature: -25 °C +120°C.
- Working temperature (VSD): -25 °C +50 °C.

Finish:

- Anticorrosive galvanized sheet steel.

Order code with variable speed drive (VSD) included

CMP-L/EW — 922 — 2 — 1.5 — B — T — D

CMP-L/EW: High-efficiency centrifugal single-inlet, medium-pressure fans with casing and sheet steel impeller, "Efficient work"

Impeller size

Number of poles:
 2=2850 r/min
 4=1400 r/min

Motor power (CV)

Industrial Brushless Motors E.C.

M: Fitted with VSD1/B, electronic variable speed, single phase power supply 220-240 V 50/60 Hz.
 T: Fitted with VSD3/B, electronic variable speed, three-phase power supply 380-415 V 50/60 Hz.

D: Standard version, VSD supplied programmed for constant speed.
 P: Supplied with VSD programmed for pressure control and Si-Presión pressure transmitter
 K: Supplied with VSD programmed for pressure control and built into a BOXPRES KIT/B box.

Technical characteristics

Model	Speed min/max (r/min)	Single-phase VSD 230 V 50/60 Hz		Three-phase VSD 400 V 50/60 Hz		Maximum electrical power (W)	Maximum airflow min/max (m³/h)	Sound pressure level min/max dB(A)	Weight approx. (Kg)
		Maximum current input (A)	Model VSD	Maximum current input (A)	Model VSD				
CMP-L/EW-512-2	300 / 2850	2.09	VSD1/B-0.37	0.61	VSD3/B-0.75	255	40 / 380	13 / 62	4.0
CMP-L/EW-512-4	300 / 1410	1.14	VSD1/B-0.37	0.34	VSD3/B-0.75	140	55 / 255	21 / 55	4.0
CMP-L/EW-514-2	300 / 2850	2.09	VSD1/B-0.37	0.61	VSD3/B-0.75	255	75 / 700	16 / 65	8.0
CMP-L/EW-514-4	300 / 1410	1.14	VSD1/B-0.37	0.34	VSD3/B-0.75	140	120 / 565	34 / 68	8.0
CMP-L/EW-616-2	300 / 2850	5.99	VSD1/B-0.37	1.76	VSD3/B-0.75	730	145 / 1380	20 / 69	9.5
CMP-L/EW-616-4	300 / 1410	1.44	VSD1/B-0.37	0.42	VSD3/B-0.75	175	180 / 850	27 / 61	9.5
CMP-L/EW-620-2	300 / 2850	5.99	VSD1/B-0.37	1.76	VSD3/B-0.75	730	80 / 765	19 / 68	9.5
CMP-L/EW-620-4	300 / 1410	1.44	VSD1/B-0.37	0.42	VSD3/B-0.75	175	170 / 810	27 / 61	9.5
CMP-L/EW-718-2	300 / 2850	8.15	VSD1/B-0.75	1.92	VSD3/B-0.75	925	155 / 1485	21 / 70	12.5
CMP-L/EW-718-4	300 / 1410	2.79	VSD1/B-0.37	0.82	VSD3/B-0.75	340	270 / 1280	29 / 63	12.5
CMP-L/EW-820-2	300 / 2850	11.80	VSD1/B-0.75	2.78	VSD3/B-1.5	1345	205 / 1950	24 / 73	15.0
CMP-L/EW-820-4	300 / 1410	2.79	VSD1/B-0.37	0.82	VSD3/B-0.75	340	355 / 1670	31 / 65	15.0
CMP-L/EW-922-2-1.5	300 / 2850	11.80	VSD1/B-0.75	2.78	VSD3/B-1.5	1345	175 / 1650	21 / 70	20.0
CMP-L/EW-922-2-2	300 / 2850	15.89	VSD1/B-1.5	3.74	VSD3/B-1.5	1810	210 / 2010	22 / 71	23.0
CMP-L/EW-922-2-3	300 / 2850	23.11	VSD1/B-2.2	5.45	VSD3/B-2.2	2630	275 / 2600	25 / 74	25.5
CMP-L/EW-922-4	300 / 1410	5.82	VSD1/B-0.75	1.37	VSD3/B-1.5	660	520 / 2450	32 / 66	19.0
CMP-L/EW-1025-2	300 / 2850	23.11	VSD1/B-2.2	5.45	VSD3/B-2.2	2630	220 / 2100	24 / 73	28.5
CMP-L/EW-1025-4	300 / 1410	11.25	VSD1/B-0.75	2.65	VSD3/B-1.5	1295	725 / 3400	36 / 70	38.5



EFFICIENT WORK



Acoustic features at maximum speed

The specified values are determined according to free field measurements of sound levels in dB(A) at an equivalent distance of twice the fan's span plus the impeller's diameter, with a minimum of 1.5 m.

Sound power Lw(A) spectrum in dB(A) via frequency band in Hz.

Model	63	125	250	500	1000	2000	4000	8000	Model	63	125	250	500	1000	2000	4000	8000
CMP-L/EW-512-2	37	47	58	65	69	66	64	57	CMP-L/EW-718-4	38	48	59	66	70	67	65	58
CMP-L/EW-512-4	30	40	51	58	62	59	57	50	CMP-L/EW-820-2	48	58	69	76	80	77	75	68
CMP-L/EW-514-2	40	50	61	68	72	69	67	60	CMP-L/EW-820-4	41	51	62	69	73	70	68	61
CMP-L/EW-514-4	33	43	54	61	65	62	60	53	CMP-L/EW-922-2-1.5	45	55	66	73	77	74	72	65
CMP-L/EW-616-2	44	54	65	72	76	73	71	64	CMP-L/EW-922-2-2	46	56	67	74	78	75	73	66
CMP-L/EW-616-4	36	46	57	64	68	65	63	56	CMP-L/EW-922-2-3	49	59	70	77	81	78	76	69
CMP-L/EW-620-2	43	53	64	71	75	72	70	63	CMP-L/EW-922-4	41	51	62	69	73	70	68	61
CMP-L/EW-620-4	36	46	57	64	68	65	63	56	CMP-L/EW-1025-2	48	58	69	76	80	77	75	68
CMP-L/EW-718-2	45	55	66	73	77	74	72	65	CMP-L/EW-1025-4	45	55	66	73	77	74	72	65

Dimensions in mm

CMP-L/EW-512...820

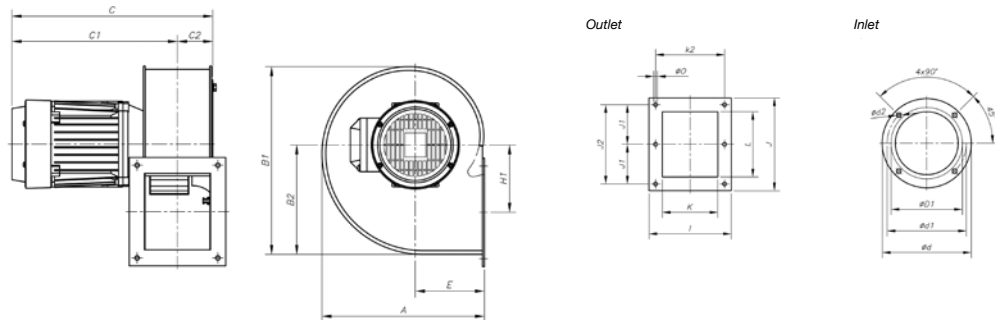

Model	A	B1	B2	C	C1	C2	øD1*	ød	ød1	ød2	E	H1	I	J	J1	J2	K	k2	L	øO
CMP-L/EW-512-2	185	206.5	118	251	212	39	112	140	132	M4	82.5	69	104	117	-	104.5	75	92	86	5.5
CMP-L/EW-512-4	185	206.5	118	251	212	39	112	140	132	M4	82.5	69	104	117	-	104.5	75	92	86	5.5
CMP-L/EW-514-2	225	254	150	281	236	45	140	169	151.5	M4	100	91	122	147	64	128	83	105	107	6.5
CMP-L/EW-514-4	225	254	150	281	236	45	140	169	151.5	M4	100	91	122	147	64	128	83	105	107	6.5
CMP-L/EW-616-2	258	297	173.5	320	264	56	160	204	180	M6	110	105.5	153	172	-	147	103	128	125	7
CMP-L/EW-616-4	258	297	173.5	283	227	56	160	204	180	M6	110	105.5	153	172	-	147	103	128	125	7
CMP-L/EW-620-2	298	347	202.5	321	265	56	200	247	230	M6	126	145.5	159	153	-	128	105	134	100	8
CMP-L/EW-620-4	298	347	202.5	283	227	56	200	247	230	M6	126	145.5	159	153	-	128	105	134	100	8
CMP-L/EW-718-2	303.5	348	201	355	294	61	180	238	210	M6	129.5	122	169	192	85	170	115	145	146	9
CMP-L/EW-718-4	303.5	348	201	331	270	61	180	238	210	M6	129.5	122	169	192	85	170	115	145	146	9
CMP-L/EW-820-2	322	377	223	369.5	301	68.5	200	247	230	M6	137.5	137	184	213	94.5	189	130	160	156	9
CMP-L/EW-820-4	322	377	223	345.5	277	68.5	200	247	230	M6	137.5	137	184	213	94.5	189	130	160	156	9

CMP-L/EW-922...1025

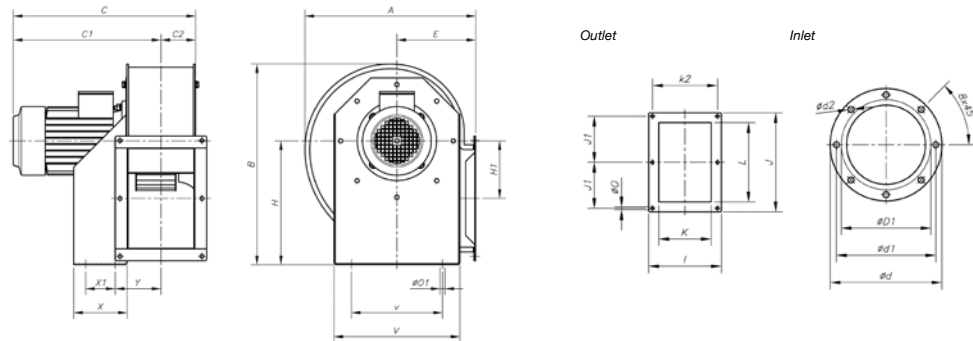

Model	A	B	C	C1	C2	øD1*	ød	ød1	ød2	E	H	H1	I	J	J1	K	k2	L	øO	øO1	V	v	X	X1	Y
CMP-L/EW-922-2-1.5	388.5	455	382.5	309	73.5	224	278	256	M8	180	280	134	204	282.5	128	140	180	215	9.5	10.5	290	220	114	50	105
CMP-L/EW-922-2-2	388.5	455	430.5	357	73.5	224	278	25	M8	180	280	134	204	282.5	128	140	180	215	9.5	10.5	290	220	114	50	105
CMP-L/EW-922-2-3	388.5	455	430.5	357	73.5	224	278	256	M8	180	280	134	204	282.5	128	140	180	215	9.5	10.5	290	220	114	50	105
CMP-L/EW-922-4T	388.5	455	382.5	309	73.5	224	278	256	M8	180	280	134	204	282.5	128	140	180	215	9.5	10.5	290	220	114	50	105
CMP-L/EW-1025-2	427	503	456	370	86	250	305	282	M8	197	310	144	229	312.5	145	165	205	250	9.5	12.5	315	228	134	74	115.5
CMP-L/EW-1025-4	427	503	456	370	86	250	305	282	M8	197	310	144	229	312.5	145	165	205	250	9.5	12.5	315	228	134	74	115.5

Positions

LG 270 standard supply. LG 180 and RD 180 positions on request and with special fixing measures



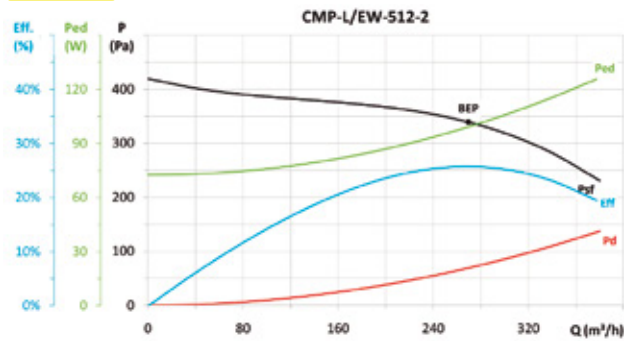

Erp. Characteristic curves and ErP data

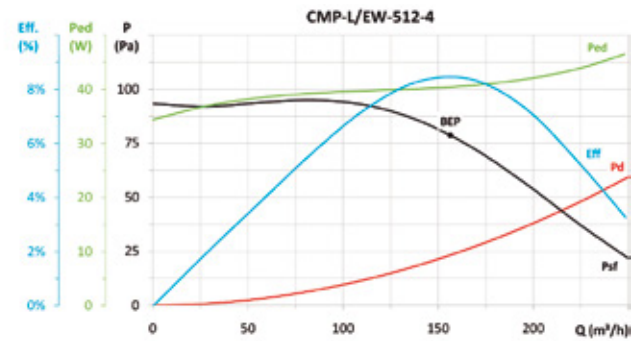
MC	EC	SR	Cc	η_b (%)*	N	[kW]	[m³/h]	[Pa]	[rpm]	VSD
A	S	-	-	-	-	0,099	270	339,2	2850	INCLUDED

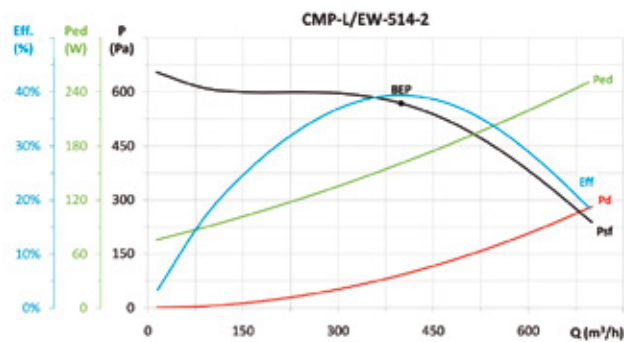

MC	EC	SR	Cc	η_b (%)*	N	[kW]	[m³/h]	[Pa]	[rpm]	VSD
A	S	-	-	-	-	0,040	156	78,7	1410	INCLUDED



MC	EC	SR	Cc	η_b (%)*	N	[kW]	[m³/h]	[Pa]	[rpm]	VSD
A	S	1,01	1,14	45,0%	56,4	0,160	399	568,1	2850	INCLUDED

* η_e (%) = Eff. (%) x Cc

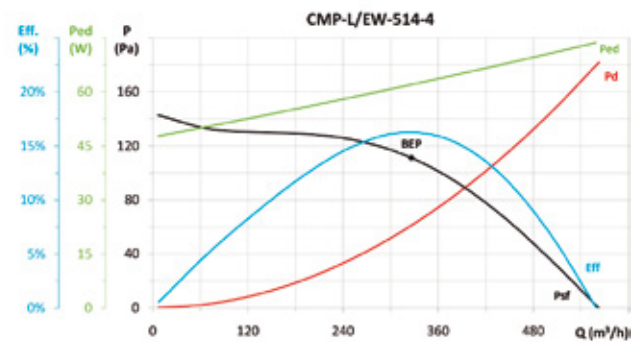

MC	EC	SR	Cc	η_b (%)*	N	[kW]	[m³/h]	[Pa]	[rpm]	VSD
A	S	-	-	-	-	0,062	326	111,2	1410	INCLUDED

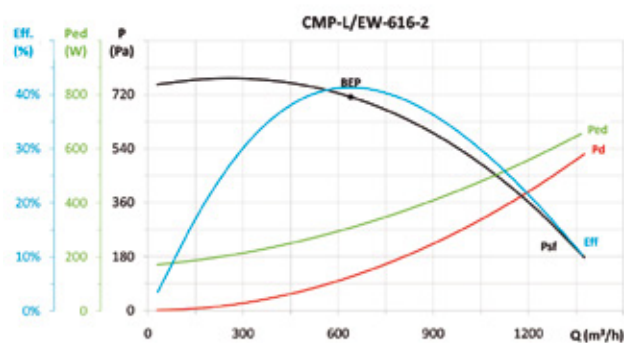

MC	EC	SR	Cc	η_b (%)*	N	[kW]	[m³/h]	[Pa]	[rpm]	VSD
A	S	1,01	1,12	46,4%	56,0	0,306	639	712,3	2850	INCLUDED

* η_e (%) = Eff. (%) x Cc

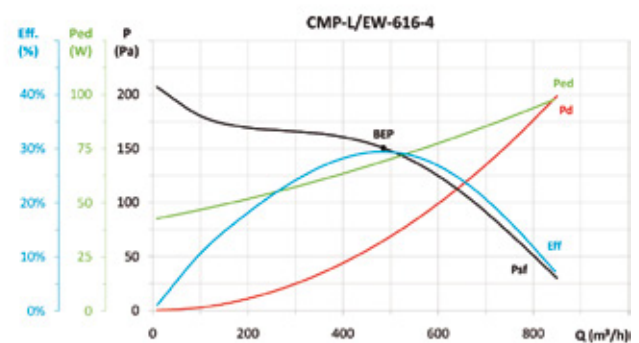

MC	EC	SR	Cc	η_b (%)*	N	[kW]	[m³/h]	[Pa]	[rpm]	VSD
A	S	-	-	-	-	0,069	485	150,6	1410	INCLUDED

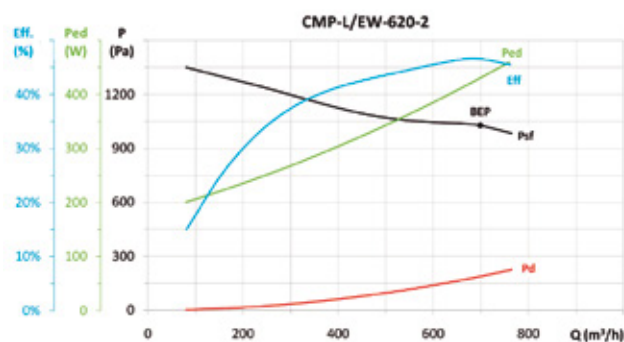

MC	EC	SR	Cc	η_b (%)*	N	[kW]	[m³/h]	[Pa]	[rpm]	VSD
A	S	1,01	1,11	51,9%	60,6	0,428	699	1027,3	2850	INCLUDED

* η_e (%) = Eff. (%) x Cc

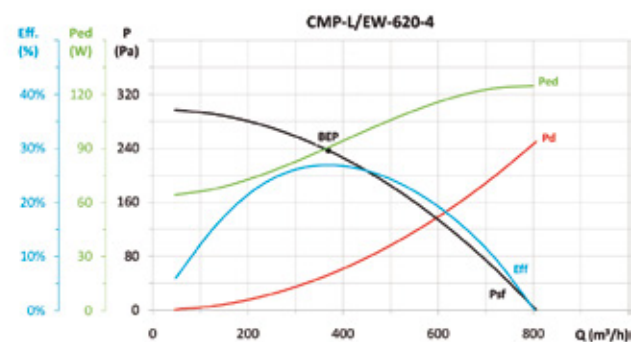

MC	EC	SR	Cc	η_b (%)*	N	[kW]	[m³/h]	[Pa]	[rpm]	VSD
A	S	-	-	-	-	0,090	369	236,7	1410	INCLUDED



EFFICIENT WORK



Erp. Characteristic curves and ErP data

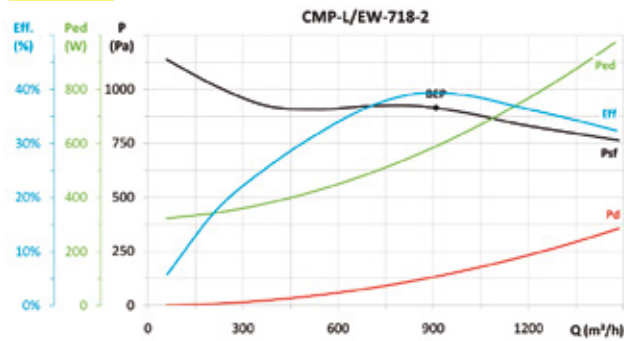

MC	EC	SR	Cc	η_e (%)*	N	[kW]	[m³/h]	[Pa]	[rpm]	VSD
A	S	1,01	1,10	43,5%	51,3	0,585	909	914,0	2850	INCLUDED

* η_e (%) = Eff. (%) x Cc

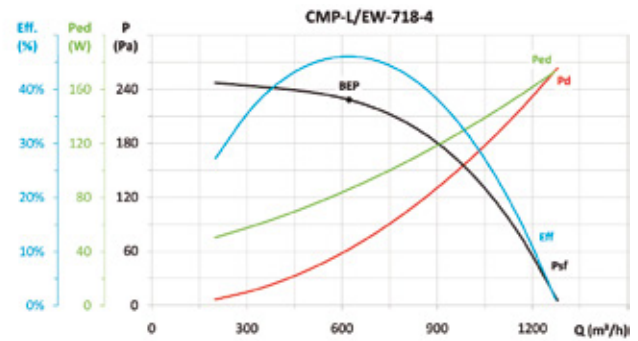

MC	EC	SR	Cc	η_e (%)*	N	[kW]	[m³/h]	[Pa]	[rpm]	VSD
A	S	-	-	-	-	0,085	622	228,3	1410	INCLUDED

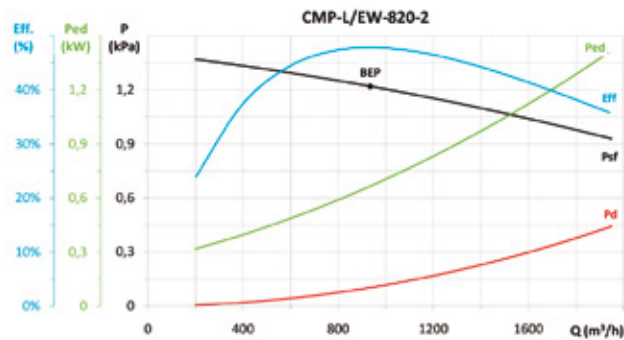

MC	EC	SR	Cc	η_e (%)*	N	[kW]	[m³/h]	[Pa]	[rpm]	VSD
A	S	1,01	1,10	52,6%	60,1	0,662	935	1220,0	2850	INCLUDED

* η_e (%) = Eff. (%) x Cc

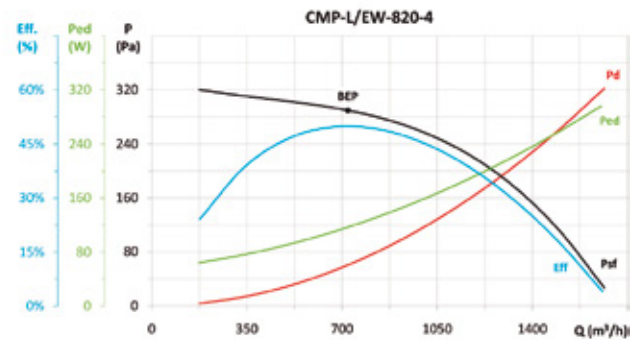

MC	EC	SR	Cc	η_e (%)*	N	[kW]	[m³/h]	[Pa]	[rpm]	VSD
A	S	-	-	-	-	0,116	721	289,6	1410	INCLUDED

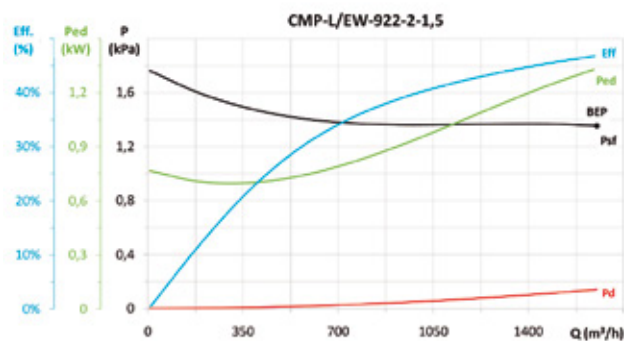

MC	EC	SR	Cc	η_e (%)*	N	[kW]	[m³/h]	[Pa]	[rpm]	VSD
A	S	1,01	1,08	50,5%	56,1	1,328	1652	1354,2	2850	INCLUDED

* η_e (%) = Eff. (%) x Cc

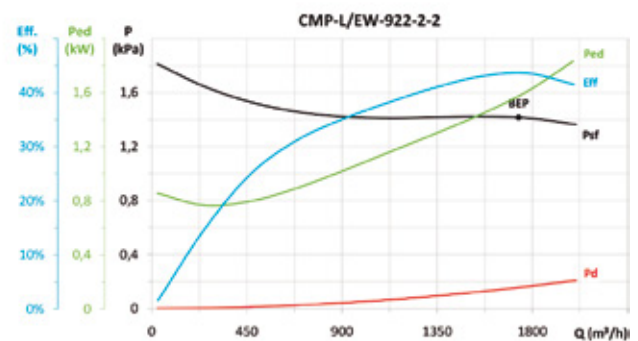

MC	EC	SR	Cc	η_e (%)*	N	[kW]	[m³/h]	[Pa]	[rpm]	VSD
A	S	1,02	1,07	46,9%	52,0	1,563	1736	1416,0	2850	INCLUDED

* η_e (%) = Eff. (%) x Cc

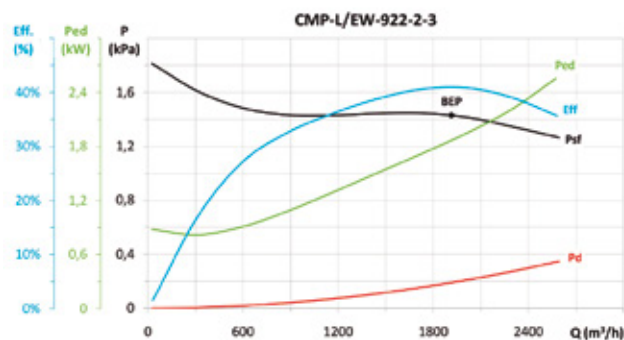

MC	EC	SR	Cc	η_e (%)*	N	[kW]	[m³/h]	[Pa]	[rpm]	VSD
A	S	1,02	1,07	43,8%	48,5	1,855	1915	1429,2	2850	INCLUDED

* η_e (%) = Eff. (%) x Cc

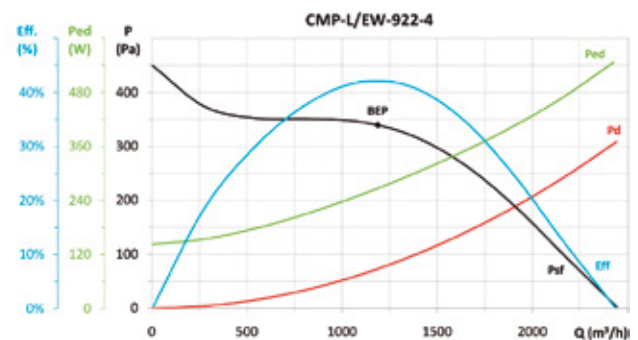

MC	EC	SR	Cc	η_e (%)*	N	[kW]	[m³/h]	[Pa]	[rpm]	VSD
A	S	1,00	1,13	47,6%	57,5	0,265	1187	339,3	1410	INCLUDED

* η_e (%) = Eff. (%) x Cc



Erp. Characteristic curves and ErP data

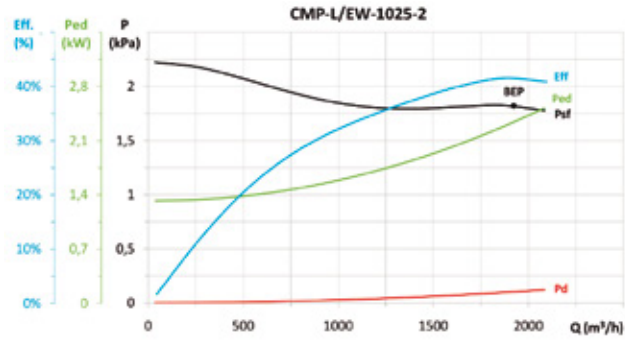

MC	EC	SR	Cc	η_s (%)*	N	[kW]	[m³/h]	[Pa]	[rpm]	VSD
A	S	1,02	1,06	44,2%	48,2	2,337	1923	1821,1	2850	INCLUDED

* η_e (%) = Eff. (%) x Cc

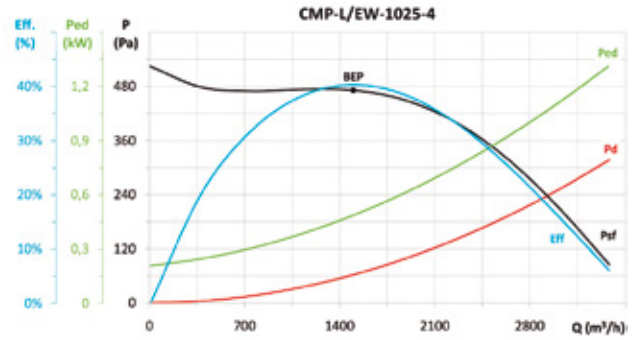

MC	EC	SR	Cc	η_s (%)*	N	[kW]	[m³/h]	[Pa]	[rpm]	VSD
A	S	1,01	1,11	44,7%	53,0	0,488	1501	471,5	1410	INCLUDED

* η_e (%) = Eff. (%) x Cc

Accessories

See accessories section.



INT



RPA



B



BD



BIC



ACE



S



REG



CONTROL UNITS AND SENSORS



EFFICIENT WORK



CMP/EW



**HIGHLY EFFICIENT
IE3-COMPLIANT
THREE-PHASE MOTORS**

High-efficiency centrifugal single-inlet, medium-pressure fans with a direct motor and impeller with forward-facing blades fitted with IE3 asynchronous motor adjustable electronically.



VARIABLE SPEED DRIVE
VSD: Variable Speed Drive
- VSD1/A-RFM
- VSD3/A-RFT
Supply on request

CONTROL
Supply optional accessory

SUPPLY
VSD1/A-RFM:
220-240 V 50/60 Hz
VSD3/A-RFT:
380-415 V 50/60 Hz

Fan:

- Steel sheet casing
- Impeller with backward-curved blades made from robust sheet steel

Motor and electronic variable speed:

- Motors with IE3 efficiency adjustable electronically.
- The variable speed drive VSD will be supplied as per order.
- Electronic variable speed drive (VSD) can be adjusted by external 0-10 V signal.
- It is advisable to install sinusoidal filters between the fan and the electronic variable speed drive (VSD) when they are far apart.
- Electronic variable speed drive (VSD), available with single-phase 220-240 V 50/60 Hz input (VSD1/B type) or three-phase 380-415 V 50/60 Hz (VSD3/B type).
- By default, the electronic variable speed drive (VSD) is delivered programmed for constant speed.
- Working fan temperature: -25 °C +120 °C.

Working temperature (VSD):

- 25 °C +50 °C.
- Class F motors, with ball bearings, IP55 protection.
- Three-phase 230/400 V. 50 Hz. (up to 5.5 CV.) and 400/690 V. 50 Hz. (power over 5.5 CV.)

Finish:

- Anticorrosive finish in polyester resin polymerised at 190°C, after alkaline degreasing with nanotechnology treatment and phosphate-free.

On request:

- Fan designed to transport air up to 250°C.
- Stainless steel fans

Fan order code

CMP/EW — 1128 — 2T — 4 — IE3

CMP/EW: High-efficiency centrifugal single-inlet, medium-pressure fans with casing and sheet steel impeller, "Efficient work"

Impeller size

Maximum speed:
2T=2950 rpm
4T=1450 rpm
6T=950 rpm

Motor power (CV)

Three-phase motor IE3

Order code with variable speed drive (VSD) included

CMP/EW — 1128 — 2T — 4 — IE3 — VSD1 — D

CMP/EW: High-efficiency centrifugal single-inlet, medium-pressure fans with casing and sheet steel impeller, "Efficient work"

Impeller size

Maximum speed:
2T=2950 rpm
4T=1450 rpm
6T=950 rpm

Motor power (CV)

Three-phase motor IE3

VSD1: Fitted with VSD1/A-RFM, electronic variable speed, single phase power supply 220-240 V 50/60 Hz.

VSD3: Fitted with VSD3/A-RFT, electronic variable speed, three-phase power supply 380-415 V 50/60 Hz.

D: Standard version, VSD supplied programmed for constant speed.
P: Supplied with VSD programmed for pressure control and Si-Presión pressure transmitter
K: Supplied with VSD programmed for pressure control and built into a BOXPRES KIT/B box. Only available for fans with motor power less than or equal to 2.2 kW.

Technical characteristics

Model	Speed min/max (r/min)	Single-phase VSD 230 V 50/60 Hz		Three-phase VSD 400 V 50/60 Hz		Maximum current Motor 50 Hz			Installed power (kW)	Maximum airflow min/max (m ³ /h)	Sound pressure level min/max dB(A)	Weight approx. (Kg)
		Maximum current input (A)	Model VSD	Maximum current input (A)	Model VSD	230V	400V (A)	690V				
CMP/EW-1025-2T-4	1165/2910	-	-	7.27	VSD3/A-RFT-5.5	10.00	5.77	-	3.00	1135 / 2830	57 / 77	37.6
CMP/EW-1128-2T-4	1165/2910	-	-	7.27	VSD3/A-RFT-5.5	10.00	5.77	-	3.00	890 / 2220	57 / 77	41.5
CMP/EW-1128-2T-5.5	1160/2900	-	-	9.44	VSD3/A-RFT-5.5	13.00	7.50	-	4.00	1285 / 3210	61 / 81	47.0
CMP/EW-1128-4T	575/1435	23.15	VSD1/A-RFM-3	6.43	VSD3/A-RFT-3	7.93	4.56	-	2.20	2005 / 5000	54 / 74	39.0
CMP/EW-1128-6T	375/940	8.69	VSD1/A-RFM-1	2.41	VSD3/A-RFT-1	3.36	1.93	-	0.75	1315 / 3300	40 / 60	28.5
CMP/EW-1231-4T-3	575/1435	23.15	VSD1/A-RFM-3	6.43	VSD3/A-RFT-3	7.93	4.56	-	2.20	1900 / 4740	53 / 73	47.0
CMP/EW-1231-4T-4	575/1440	-	-	7.20	VSD3/A-RFT-5.5	10.70	6.15	-	3.00	2360 / 5910	55 / 75	49.0
CMP/EW-1231-4T-5.5	580/1450	-	-	9.48	VSD3/A-RFT-5.5	13.90	8.00	-	4.00	2740 / 6850	57 / 77	56.0
CMP/EW-1231-6T	380/950	16.64	VSD1/A-RFM-2	4.62	VSD3/A-RFT-2	6.43	3.70	-	1.50	2045 / 5115	44 / 64	49.0
CMP/EW-1435-4T-4	575/1440	-	-	7.20	VSD3/A-RFT-5.5	10.70	6.15	-	3.00	2220 / 5560	56 / 76	53.0
CMP/EW-1435-4T-5.5	580/1450	-	-	9.48	VSD3/A-RFT-5.5	13.90	8.00	-	4.00	2505 / 6260	58 / 78	61.5
CMP/EW-1435-4T-7.5	585/1465	-	-	12.81	VSD3/A-RFT-7.5	-	10.30	5.97	5.50	2880 / 7210	60 / 80	75.5
CMP/EW-1435-6T	380/950	23.83	VSD1/A-RFM-3	6.62	VSD3/A-RFT-3	9.08	5.22	-	2.20	2560 / 6400	46 / 66	58.5
CMP/EW-1640-4T-5.5	580/1450	-	-	9.48	VSD3/A-RFT-5.5	13.90	8.00	-	4.00	2800 / 7000	57 / 77	78.5
CMP/EW-1640-4T-7.5	585/1465	-	-	12.81	VSD3/A-RFT-7.5	-	10.30	5.97	5.50	3210 / 8035	60 / 80	92.5
CMP/EW-1640-4T-10	585/1465	-	-	17.32	VSD3/A-RFT-10	-	13.90	8.06	7.50	3875 / 9710	62 / 82	103.5
CMP/EW-1640-6T	380/950	23.83	VSD1/A-RFM-3	6.62	VSD3/A-RFT-3	9.08	5.22	-	2.20	3240 / 8100	51 / 71	75.5
CMP/EW-1845-4T-7.5	585/1465	-	-	12.81	VSD3/A-RFT-7.5	-	10.30	5.97	5.50	3195 / 8000	62 / 82	93.5
CMP/EW-1845-4T-10	585/1465	-	-	17.32	VSD3/A-RFT-10	-	13.90	8.06	7.50	3995 / 10000	65 / 85	104.5
CMP/EW-1845-6T	380/950	23.83	VSD1/A-RFM-3	6.62	VSD3/A-RFT-3	9.08	5.22	-	2.20	3000 / 7500	57 / 77	84.0
CMP/EW-2050-4T-10	585/1465	-	-	17.32	VSD3/A-RFT-10	-	13.90	8.06	7.50	3595 / 9000	63 / 83	134.0
CMP/EW-2050-4T-15	590/1470	-	-	25.10	VSD3/A-RFT-15	-	21.40	12.40	11.00	5025 / 12525	67 / 87	153.0
CMP/EW-2050-4T-20	585/1465	-	-	34.41	VSD3/A-RFT-20	-	28.70	16.60	15.00	6590 / 16500	69 / 89	172.0
CMP/EW-2050-6T	580/1450	-	-	9.48	VSD3/A-RFT-5.5	13.90	8.00	-	4.00	4400 / 11000	59 / 79	146.0
CMP/EW-2563-6T	390/975	-	-	34.45	VSD3/A-RFT-20	-	28.00	16.20	15.00	8400 / 21000	66 / 86	251.0

Acoustic features at maximum speed

The specified values are determined according to free field measurements of sound levels in dB(A) at an equivalent distance of twice the fan's span plus the impeller's diameter, with a minimum of 1.5 m.

Sound power Lw(A) spectrum in dB(A) via frequency band in Hz.

Model	63	125	250	500	1000	2000	4000	8000	Model	63	125	250	500	1000	2000	4000	8000
CMP/EW-1025-2T-4	52	62	73	80	84	81	79	72	CMP/EW-1640-4T-5.5	55	64	75	82	86	84	82	75
CMP/EW-1128-2T-4	52	62	73	80	84	81	79	72	CMP/EW-1640-4T-7.5	58	67	78	85	89	87	85	78
CMP/EW-1128-2T-5.5	56	66	77	84	88	85	83	76	CMP/EW-1640-4T-10	60	69	80	87	91	89	87	80
CMP/EW-1128-4T	49	59	70	77	81	78	76	69	CMP/EW-1640-6T	49	58	69	76	80	78	76	69
CMP/EW-1128-6T	35	45	56	63	67	64	62	55	CMP/EW-1845-4T-7.5	61	71	82	89	93	91	89	81
CMP/EW-1231-4T-3	51	60	71	78	82	80	78	71	CMP/EW-1845-4T-10	64	74	85	92	96	94	92	84
CMP/EW-1231-4T-4	53	62	73	80	84	82	80	73	CMP/EW-1845-6T	56	66	77	84	88	86	84	76
CMP/EW-1231-4T-5.5	55	64	75	82	86	84	82	75	CMP/EW-2050-4T-10	62	72	83	90	94	92	90	82
CMP/EW-1231-6T	42	51	62	69	73	71	69	62	CMP/EW-2050-4T-15	66	76	87	94	98	96	94	86
CMP/EW-1435-4T-4	54	63	74	81	85	83	81	74	CMP/EW-2050-4T-20	68	78	89	96	100	98	96	88
CMP/EW-1435-4T-5.5	56	65	76	83	87	85	83	76	CMP/EW-2050-6T	58	68	79	86	90	88	86	78
CMP/EW-1435-4T-7.5	58	67	78	85	89	87	85	78	CMP/EW-2563-6T	67	77	88	95	99	96	94	87
CMP/EW-1435-6T	44	53	64	71	75	73	71	64									



EFFICIENT WORK



Dimensions in mm

CMP/EW-1025...1231

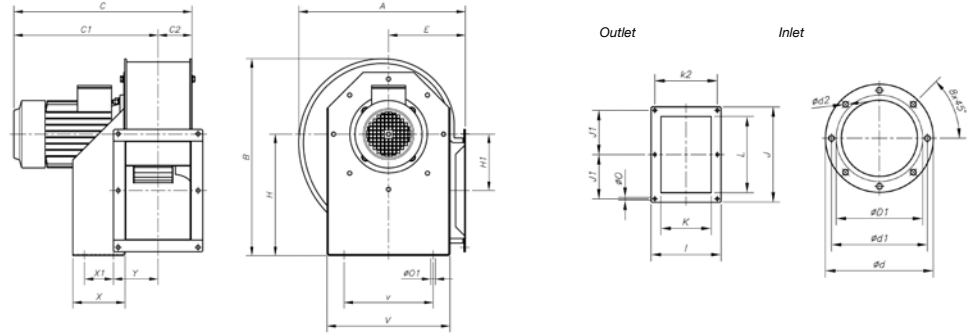

CMP/EW-1435...2563

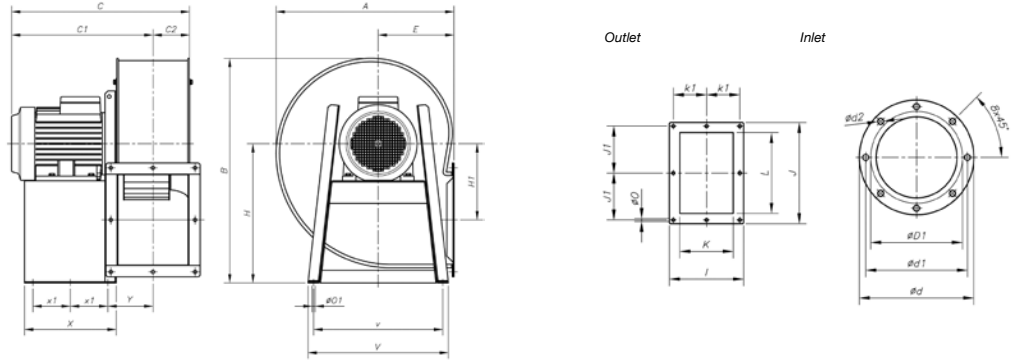

Model	A	B	C	C1	C2	C2øD1*	ød	ød1	ød2	E	H	H1	I	J	J1	K	k1	k2	L	øO	øO1	V	v	X	X1	Y
CMP/EW-1025-2T-4	427	503	486	400	86	250	305	282	M8	197	310	144	229	312.5	145	165	-	205	250	9.5	12.5	315	228	134	74	115.5
CMP/EW-1128-2T-4	472	553	500.5	407	93.5	280	348	320	M8	216	340	152	244	364	170	180	-	220	296.5	9.5	12.5	348	245	144	95	122.5
CMP/EW-1128-2T-5.5	472	553	523.5	430	93.5	280	348	320	M8	216	340	152	244	364	170	180	-	220	296.5	9.5	12.5	348	245	144	95	122.5
CMP/EW-1128-4T	472	553	500.5	407	93.5	280	348	320	M8	216	340	152	244	364	170	180	-	220	296.5	9.5	12.5	348	245	144	95	122.5
CMP/EW-1128-6T	472	553	470.5	377	93.5	280	348	320	M8	216	340	152	244	364	170	180	-	220	296.5	9.5	12.5	348	245	144	95	122.5
CMP/EW-1231-4T-3	526	630	520.5	417	103.5	315	382	354	M8	238	390	179.5	264	382.5	180	200	-	240	320	11.5	13	382	322	183	140	126
CMP/EW-1231-4T-4	526	630	520.5	417	103.5	315	382	354	M8	238	390	179.5	264	382.5	180	200	-	240	320	11.5	13	382	322	183	140	126
CMP/EW-1231-4T-5.5	526	630	543.5	440	103.5	315	382	354	M8	238	390	179.5	264	382.5	180	200	-	240	320	11.5	13	382	322	183	140	126
CMP/EW-1231-6T	526	630	520.5	417	103.5	315	382	354	M8	238	390	179.5	264	382.5	180	200	-	240	320	11.5	13	382	322	183	140	126
CMP/EW-1435-4T-4	573.5	715	549	431	118	355	422	394	M8	250	445	242.5	292	342.5	159	228	133	-	280	11.5	12	456	420	333	136.5	150
CMP/EW-1435-4T-5.5	573.5	715	572	454	118	355	422	394	M8	250	445	242.5	292	342.5	159	228	133	-	280	11.5	12	456	420	333	136.5	150
CMP/EW-1435-4T-7.5	573.5	715	610	492	118	355	422	394	M8	250	445	242.5	292	342.5	159	228	133	-	280	11.5	12	456	420	333	136.5	150
CMP/EW-1435-6T	573.5	715	572	454	118	355	422	394	M8	250	445	242.5	292	342.5	159	228	133	-	280	11.5	12	456	420	333	136.5	150
CMP/EW-1640-4T-5.5	634	799	596	465	130	400	464	438	M8	270	495	271	336	404	185	250	150	-	321	11.5	12	500	460	327	133.5	162.5
CMP/EW-1640-4T-7.5	634	799	634	504	130	400	464	438	M8	270	495	271	336	404	185	250	150	-	321	11.5	12	500	460	327	133.5	162.5
CMP/EW-1640-4T-10	634	799	634	504	130	400	464	438	M8	270	495	271	336	404	185	250	150	-	321	11.5	12	500	460	327	133.5	162.5
CMP/EW-1640-6T	634	799	596	466	130	400	464	438	M8	270	495	271	336	404	185	250	150	-	321	11.5	12	500	460	327	133.5	162.5
CMP/EW-1845-4T-7.5	711	901	668	521	147	450	515	485	M8	302	560	305	370	444	202	284	164	-	361	11.5	12	538	502	340	140	179.5
CMP/EW-1845-4T-10	711	901	668	521	147	450	515	485	M8	302	560	305	370	444	202	284	164	-	361	11.5	12	538	502	340	140	179.5
CMP/EW-1845-6T	711	901	630	483	147	450	515	485	M8	302	560	305	370	444	202	284	164	-	361	11.5	12	538	502	340	140	179.5
CMP/EW-2050-4T-10	797	987	700.5	538	162.5	500	565	535	M10	345	610	313	411	544	250	315	182.5	-	451	11.5	12	653	615	435	188	196
CMP/EW-2050-4T-15	797	987	805.5	643	162.5	500	565	535	M10	345	610	313	411	544	250	315	182.5	-	451	11.5	12	653	615	435	188	196
CMP/EW-2050-4T-20	797	987	805.5	643	162.5	500	565	535	M10	345	610	313	411	544	250	315	182.5	-	451	11.5	12	653	615	435	188	196
CMP/EW-2050-6T	797	987	700.5	538	162.5	500	565	535	M10	345	610	313	411	544	250	315	182.5	-	451	11.5	12	653	615	435	188	196
CMP/EW-2563-6T	1027	1213	1016	805	211	630	710	675	M10	460	742	378	512	706	330	410	230	-	600	17	14	590	540	450	200	239

Positions

LG 270 standard supply. LG 180 and RD 180 positions on request and with special fixing measures





Erp. Characteristic curves and ErP data

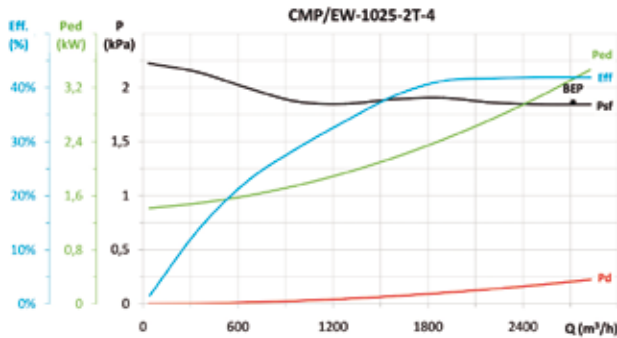

MC	EC	SR	Cc	η_e (%)*	N	[kW]	[m³/h]	[Pa]	[rpm]	VSD
A	S	1,02	1,05	44,5%	47,6	3,320	2717	1862,8	2917	NECESSARY

* η_e (%) = Eff. (%) x Cc

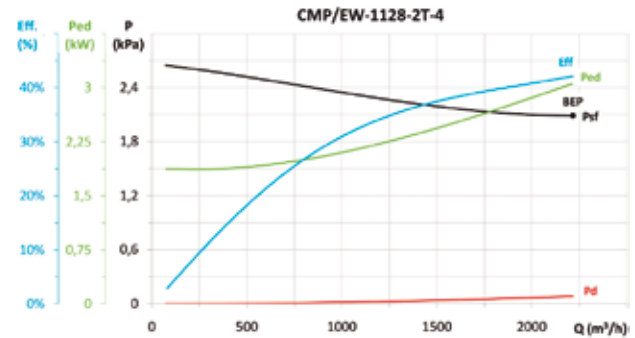

MC	EC	SR	Cc	η_e (%)*	N	[kW]	[m³/h]	[Pa]	[rpm]	VSD
A	S	1,02	1,05	44,4%	47,7	3,054	2216	2089,1	2924	NECESSARY

* η_e (%) = Eff. (%) x Cc

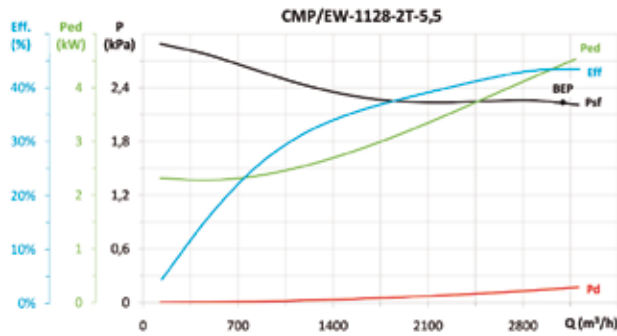

MC	EC	SR	Cc	η_e (%)*	N	[kW]	[m³/h]	[Pa]	[rpm]	VSD
A	S	1,02	1,04	45,5%	47,8	4,409	3095	2236	2906	NECESSARY

* η_e (%) = Eff. (%) x Cc

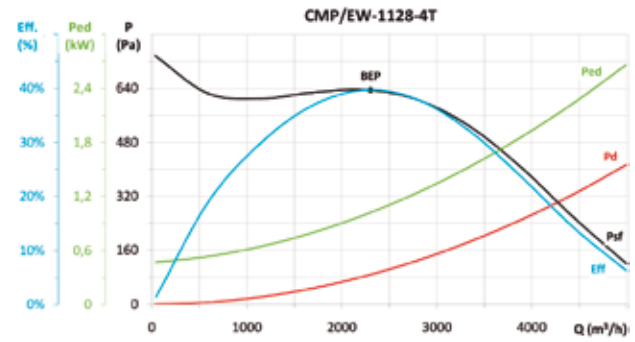

MC	EC	SR	Cc	η_e (%)*	N	[kW]	[m³/h]	[Pa]	[rpm]	VSD
A	S	1,01	1,09	43,2%	49,4	1,022	2303	634,5	1475	NECESSARY

* η_e (%) = Eff. (%) x Cc

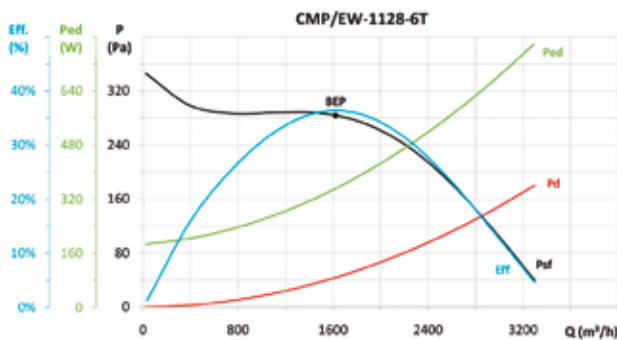

MC	EC	SR	Cc	η_e (%)*	N	[kW]	[m³/h]	[Pa]	[rpm]	VSD
A	S	1,00	1,12	40,7%	49,9	0,351	1622	283,9	979	NECESSARY

* η_e (%) = Eff. (%) x Cc

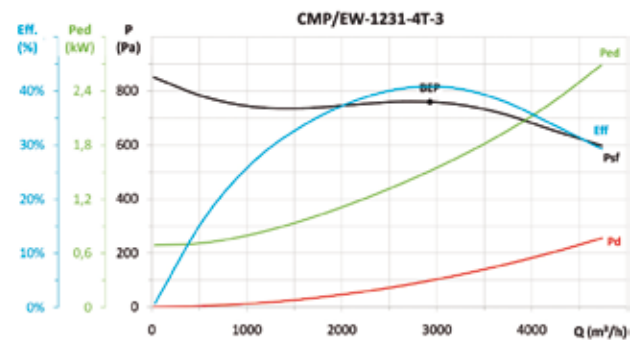

MC	EC	SR	Cc	η_e (%)*	N	[kW]	[m³/h]	[Pa]	[rpm]	VSD
A	S	1,01	1,08	43,9%	49,1	1,512	2927	759,5	1463	NECESSARY

* η_e (%) = Eff. (%) x Cc

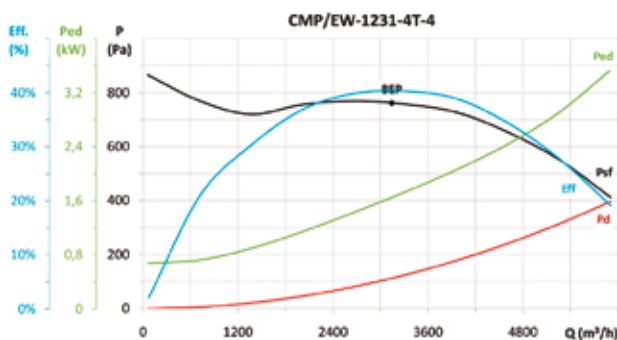

MC	EC	SR	Cc	η_e (%)*	N	[kW]	[m³/h]	[Pa]	[rpm]	VSD
A	S	1,01	1,07	43,2%	48,2	1,650	3143	761,5	1472	NECESSARY

* η_e (%) = Eff. (%) x Cc

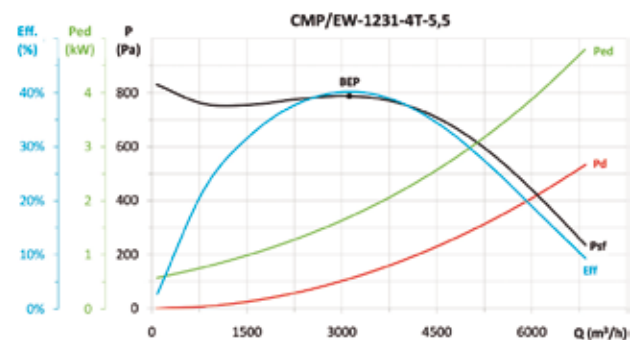

MC	EC	SR	Cc	η_e (%)*	N	[kW]	[m³/h]	[Pa]	[rpm]	VSD
A	S	1,01	1,07	43,1%	47,9	1,699	3120	787,7	1482	NECESSARY

* η_e (%) = Eff. (%) x Cc



EFFICIENT WORK



Erp. Characteristic curves and ErP data

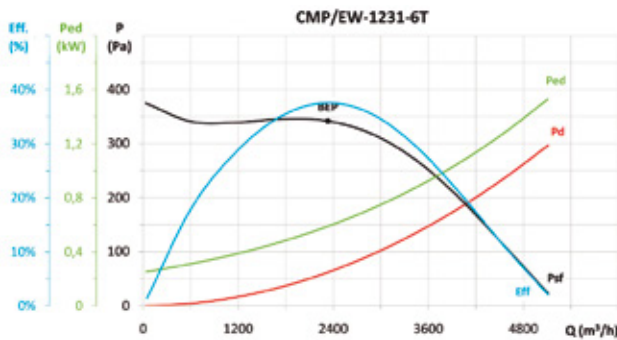

MC	EC	SR	Cc	η_e (%)*	N	[kW]	[m³/h]	[Pa]	[rpm]	VSD
A	S	1,01	1,10	41,5%	49,3	0,589	2332	341,9	985	NECESSARY

* η_e (%) = Eff. (%) x Cc

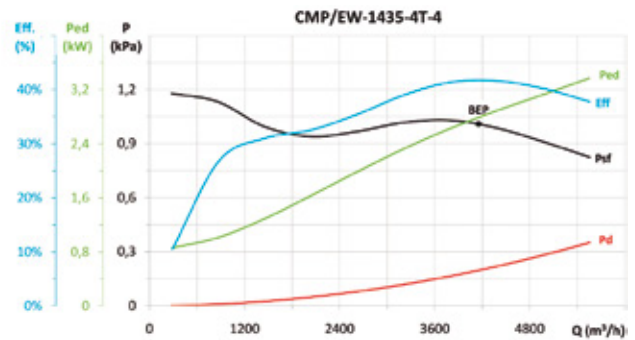

MC	EC	SR	Cc	η_e (%)*	N	[kW]	[m³/h]	[Pa]	[rpm]	VSD
A	S	1,01	1,06	44,2%	47,7	2,788	4153	1009,6	1453	NECESSARY

* η_e (%) = Eff. (%) x Cc

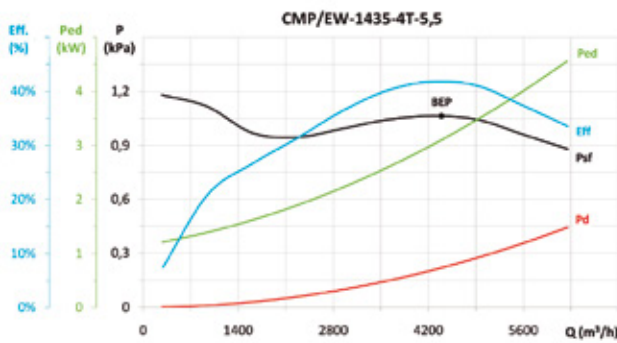

MC	EC	SR	Cc	η_e (%)*	N	[kW]	[m³/h]	[Pa]	[rpm]	VSD
A	S	1,01	1,05	44,1%	47,4	3,099	4394	1062,9	1467	NECESSARY

* η_e (%) = Eff. (%) x Cc

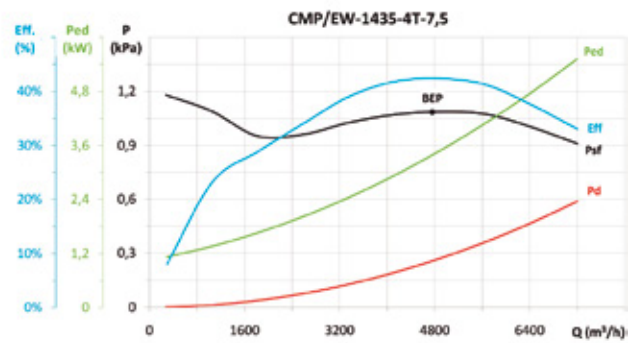

MC	EC	SR	Cc	η_e (%)*	N	[kW]	[m³/h]	[Pa]	[rpm]	VSD
A	S	1,01	1,05	44,6%	47,6	3,384	4761	1084,8	1481	NECESSARY

* η_e (%) = Eff. (%) x Cc

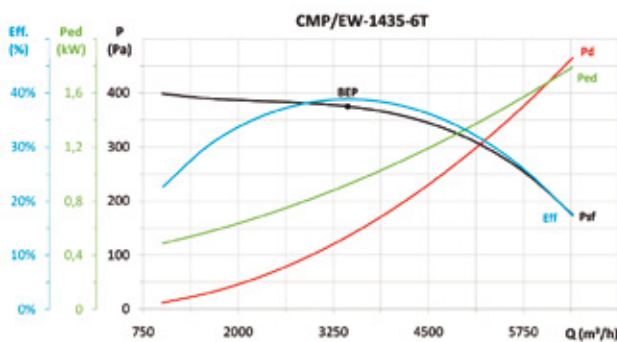

MC	EC	SR	Cc	η_e (%)*	N	[kW]	[m³/h]	[Pa]	[rpm]	VSD
A	S	1,01	1,09	42,3%	48,9	0,923	3441	374,9	983	NECESSARY

* η_e (%) = Eff. (%) x Cc

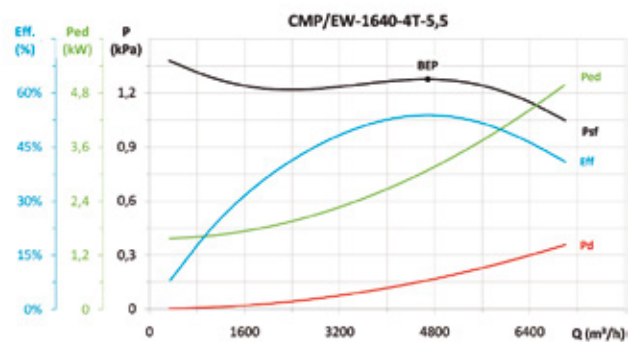

MC	EC	SR	Cc	η_e (%)*	N	[kW]	[m³/h]	[Pa]	[rpm]	VSD
A	S	1,01	1,05	56,8%	60,0	3,084	4685	1276,2	1467	NECESSARY

* η_e (%) = Eff. (%) x Cc

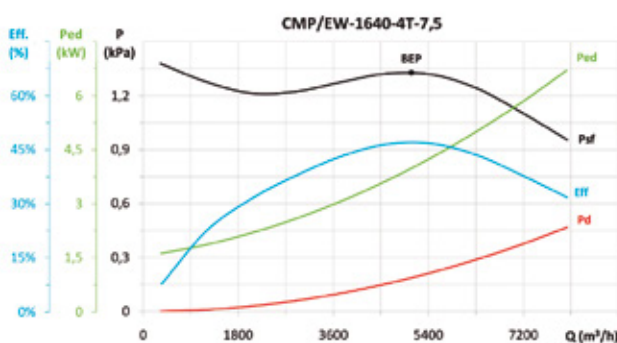

MC	EC	SR	Cc	η_e (%)*	N	[kW]	[m³/h]	[Pa]	[rpm]	VSD
A	S	1,01	1,05	49,2%	51,8	3,982	5080	1327,6	1478	NECESSARY

* η_e (%) = Eff. (%) x Cc

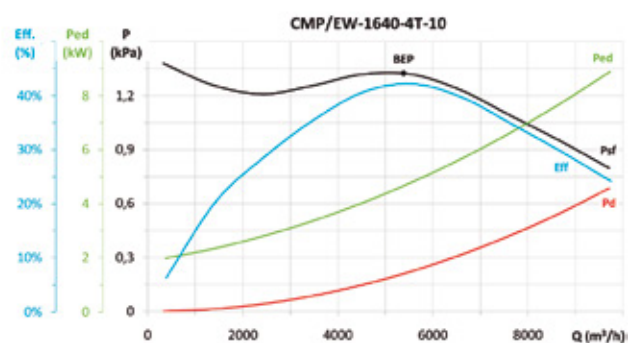

MC	EC	SR	Cc	η_e (%)*	N	[kW]	[m³/h]	[Pa]	[rpm]	VSD
A	S	1,02	1,04	44,0%	46,1	4,690	5382	1324,3	1481	NECESSARY

* η_e (%) = Eff. (%) x Cc



Erp. Characteristic curves and ErP data

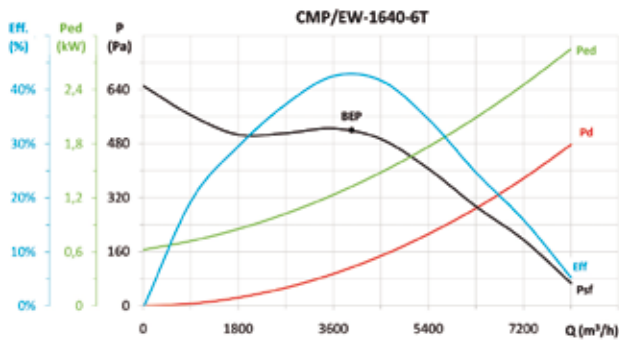

MC	EC	SR	Cc	η_e (%)*	N	[kW]	[m³/h]	[Pa]	[rpm]	VSD
A	S	1,01	1,08	46,5%	52,0	1,324	3946	519,9	976	NECESSARY

* η_e (%) = Eff. (%) x Cc

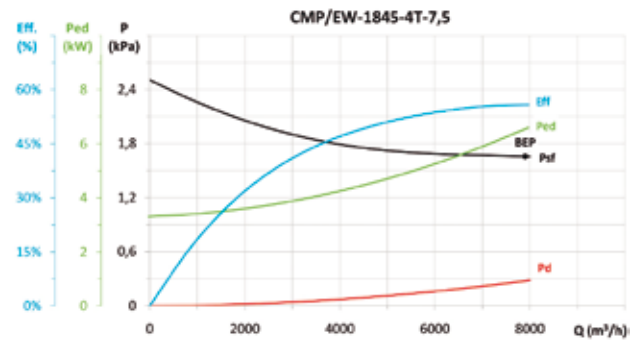

MC	EC	SR	Cc	η_e (%)*	N	[kW]	[m³/h]	[Pa]	[rpm]	VSD
A	S	1,04	1,04	58,1%	59,3	6,521	7900	1659,1	1464	NECESSARY

* η_e (%) = Eff. (%) x Cc

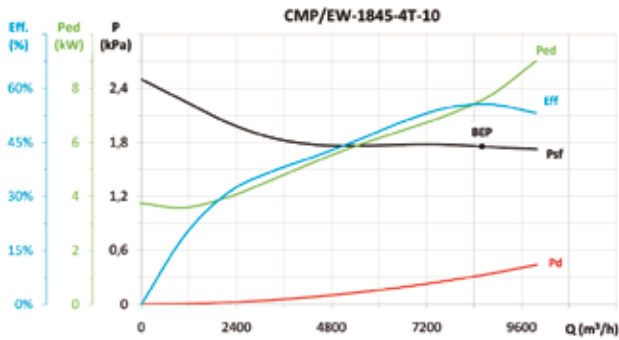

MC	EC	SR	Cc	η_e (%)*	N	[kW]	[m³/h]	[Pa]	[rpm]	VSD
A	S	1,02	1,04	57,8%	58,6	7,538	8599	1754,7	1469	NECESSARY

* η_e (%) = Eff. (%) x Cc

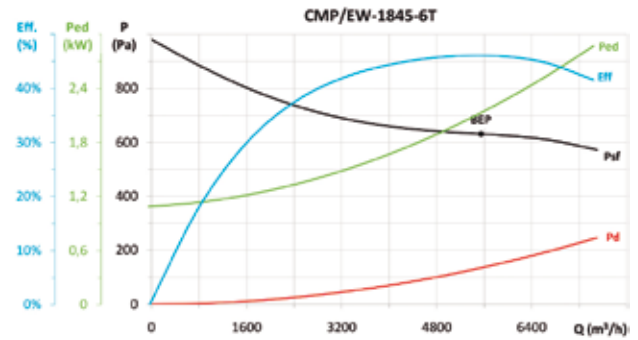

MC	EC	SR	Cc	η_e (%)*	N	[kW]	[m³/h]	[Pa]	[rpm]	VSD
A	S	1,01	1,07	49,1%	53,4	2,109	5546	631,1	962	NECESSARY

* η_e (%) = Eff. (%) x Cc

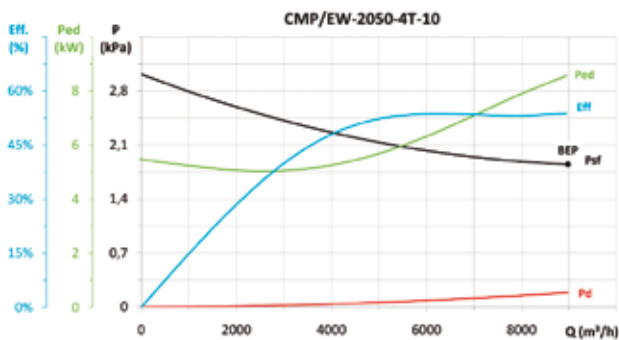

MC	EC	SR	Cc	η_e (%)*	N	[kW]	[m³/h]	[Pa]	[rpm]	VSD
A	S	1,02	1,04	56,0%	56,4	8,565	8977	1847,8	1465	NECESSARY

* η_e (%) = Eff. (%) x Cc

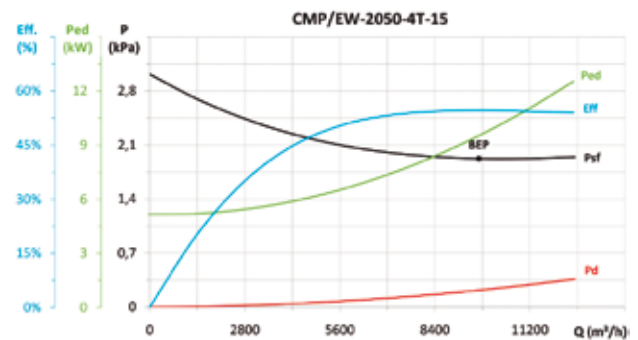

MC	EC	SR	Cc	η_e (%)*	N	[kW]	[m³/h]	[Pa]	[rpm]	VSD
A	S	1,02	1,04	56,8%	57,0	9,478	9695	1921,9	1477	NECESSARY

* η_e (%) = Eff. (%) x Cc

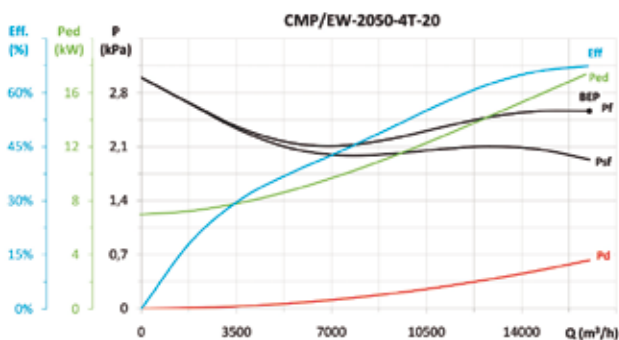

MC	EC	SR	Cc	η_e (%)*	N	[kW]	[m³/h]	[Pa]	[rpm]	VSD
B	T	1,03	1,04	70,1%	69,8	17,416	16500	2561,2	1464	NECESSARY

* η_e (%) = Eff. (%) x Cc

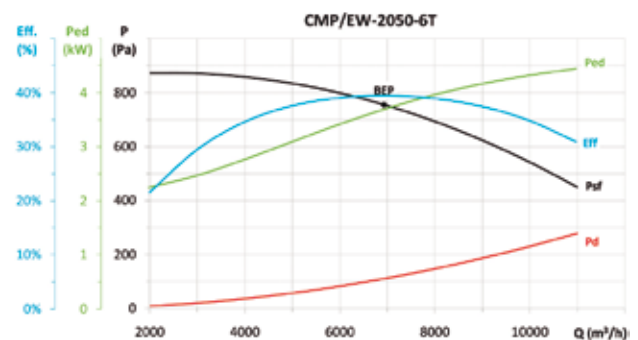

MC	EC	SR	Cc	η_e (%)*	N	[kW]	[m³/h]	[Pa]	[rpm]	VSD
A	S	1,01	1,05	41,4%	44,1	3,684	6929	755,4	1458	NECESSARY

* η_e (%) = Eff. (%) x Cc



EFFICIENT WORK



Erp. Characteristic curves and ErP data

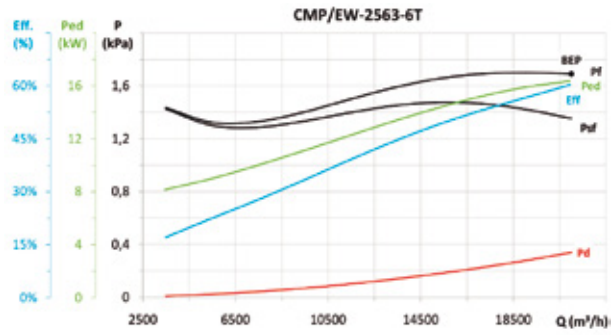

MC	EC	SR	Cc	η_v (%)*	N	[kW]	[m³/h]	[Pa]	[rpm]	VSD
B	T	1,02	1,04	62,7%	62,4	16,362	21000	1691,3	976	NECESSARY

* η_e (%) = Eff. (%) x Cc

Accessories

See accessories section.



INT



VSD1/A-RFM
VSD3/A-RFT



AET



RPA



B



BD



BIC



ACE



S



REG



CONTROL UNITS
AND SENSORS

CMR-L/EW



VARIABLE SPEED DRIVE
VSD: Variable Speed Drive.
• VSD1/B
• VSD3/B
Supply included with fan

CONTROL
Supply optional accessory

SUPPLY
VSD1/B:
220-240 V 50/60 Hz
VSD3/B:
380-415 V 50/60 Hz

Centrifugal single-inlet, medium-pressure fans with direct motor and impeller with backward-facing blades fitted with industrial BRUSHLESS motor E.C.

Fan:

- Steel sheet casing
- Impeller with backward-curved blades made from robust sheet steel
- Electronic variable speed (VSD), three-phase or single-phase, is supplied with fan.

Motor and electronic variable speed:

- High-efficiency Industrial Brushless Motors E.C., fitted with electronic variable speed (VSD), adjustable via external control input 0-10V.
- It is advisable to install an electronic variable speed drive (VSD) outside the working area.
- The external signal can be supplied through a manual or automatic control with 0-10 V output.
- Electronic variable speed drive (VSD), available with single-phase 220-240 V 50/60 Hz input (VSD1/B type) or three-phase 380-415 V 50/60 Hz (VSD3/B type).
- By default, the electronic variable

speed drive (VSD) is delivered programmed for constant speed.

- Working fan temperature: -25 °C +120 °C.
- Working temperature (VSD): -25 °C +50 °C.

Finish:

- Anticorrosive finish in polyester resin polymerised at 190°C, after alkaline degreasing with nanotechnology treatment and phosphate-free.

On request:

- Stainless steel fans

Order code with variable speed drive (VSD) included

CMR-L/EW — 622 — 2 — B — T — D

CMR-L/EW: High efficiency robust centrifugal single-inlet, medium-pressure fans fitted with an impeller with backward-facing blades, "Efficient work"

Impeller size

Number of poles:
2=2850 r/min

Industrial Brushless Motors E.C.

M: Fitted with VSD1/B, electronic variable speed, single phase power supply 220-240 V 50/60 Hz.

T: Fitted with VSD3/B, electronic variable speed, three-phase power supply 380-415 V 50/60 Hz.

D: Standard version, VSD supplied programmed for constant speed.

P: Supplied with VSD programmed for pressure control and Si-Presión pressure transmitter

K: Supplied with VSD programmed for pressure control and built into a BOXPRES KIT/B box.

Technical characteristics

Model	Speed min/max (r/min)	Single-phase VSD 230 V 50/60 Hz		Three-phase VSD 400 V 50/60 Hz		Maximum electrical power (W)	Maximum airflow min/max (m³/h)	Sound pressure level min/max dB(A)	Weight approx. (Kg)
		Maximum current input (A)	Model VSD	Maximum current input (A)	Model VSD				
CMR-L/EW-622-2	300 / 2850	2.86	VSD1/B-0.37	0.84	VSD3/B-0.75	345	110 / 1040	25 / 74	11.6
CMR-L/EW-625-2	300 / 2850	4.08	VSD1/B-0.37	1.20	VSD3/B-0.75	495	135 / 1280	26 / 75	13.7
CMR-L/EW-728-2	300 / 2850	5.99	VSD1/B-0.37	1.76	VSD3/B-0.75	730	190 / 1800	27 / 76	17.6
CMR-L/EW-731-2	300 / 2850	8.15	VSD1/B-0.75	1.92	VSD3/B-0.75	925	245 / 2350	28 / 77	22.8

Acoustic features at maximum speed

The specified values are determined according to free field measurements of sound levels in dB(A) at an equivalent distance of twice the fan's span plus the impeller's diameter, with a minimum of 1.5 m.

Sound power Lw(A) spectrum in dB(A) via frequency band in Hz.

Model	63	125	250	500	1000	2000	4000	8000	Model	63	125	250	500	1000	2000	4000	8000
CMR-L/EW-622-2	59	72	72	85	80	80	80	73	CMR-L/EW-728-2	61	74	74	87	82	82	82	75
CMR-L/EW-625-2	60	73	73	86	81	81	81	74	CMR-L/EW-731-2	62	75	75	88	83	83	83	76



EFFICIENT WORK



Dimensions in mm

CMR-L/EW-622...731

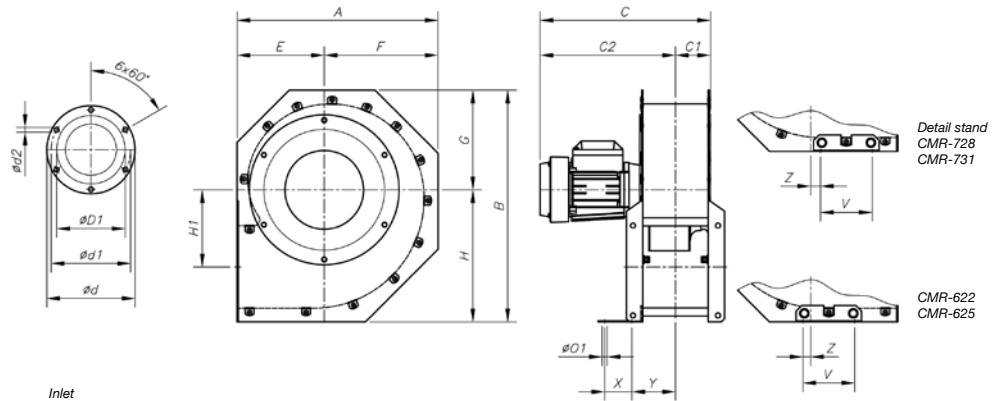

Model	Inlet																		
	A	B	C	C1	C2	$\phi D1^*$	ϕd	$\phi d1$	$\phi d2$	E	F	G	H	H1	$\phi O1$	V	X	Y	Z
CMR-L/EW-622-2	364	415.5	338.5	64	274.5	162	284	256	9.5	160	204	178	237.5	141.5	9	95	50	80	14
CMR-L/EW-625-2	407	457	343.5	66.5	277	160	315	282	9.5	183	224	195.5	261.5	155	9	95	50	82.5	6
CMR-L/EW-728-2	453.5	506.5	357.5	72.5	285	192	354	320	9.5	205	248.5	216	290.5	176	9	95	50	88.2	6.5
CMR-L/EW-731-2	507	564	374	70	304	192	382	354	9.5	230	277	240.5	323.5	197.5	9	95	50	85.2	20.5

* Recommended nominal diameter for duct.

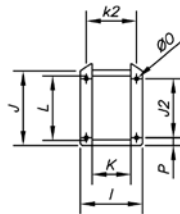

Outlet

Model	I	J	J2	K	k2	L	ϕO	S
CMR-L/EW-622-2	180	191.5	165	120	156	150	9	12
CMR-L/EW-625-2	185	207.5	181.5	125	161	167.5	9	12
CMR-L/EW-728-2	196.5	234.5	202	136.5	172.5	187.5	9	12
CMR-L/EW-731-2	190.5	250.5	227.5	130.5	166.5	211	9	12



Erp. Characteristic curves and ErP data

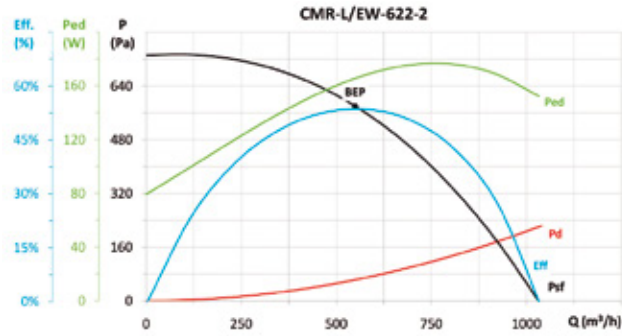

MC	EC	SR	Cc	η_b (%)*	N	[kW]	[m³/h]	[Pa]	[rpm]	VSD
A	S	1,01	1,14	61,2%	79,9	0,165	550	580	2850	INCLUDED

* η_e (%) = Eff. (%) x Cc

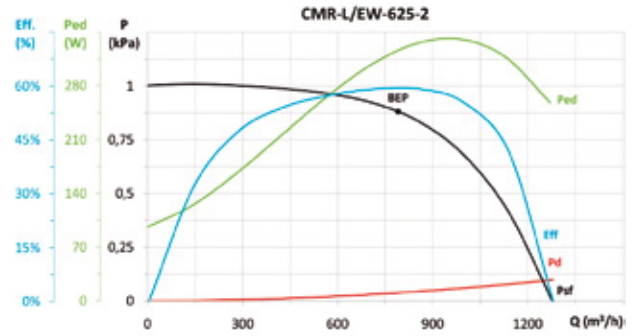

MC	EC	SR	Cc	η_b (%)*	N	[kW]	[m³/h]	[Pa]	[rpm]	VSD
A	S	1,01	1,12	66,7%	82,3	0,325	791	881	2850	INCLUDED

* η_e (%) = Eff. (%) x Cc

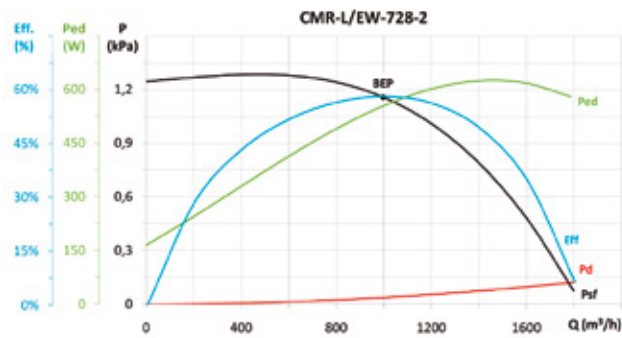

MC	EC	SR	Cc	η_b (%)*	N	[kW]	[m³/h]	[Pa]	[rpm]	VSD
A	S	1,01	1,11	64,2%	77,4	0,552	997	1157	2850	INCLUDED

* η_e (%) = Eff. (%) x Cc

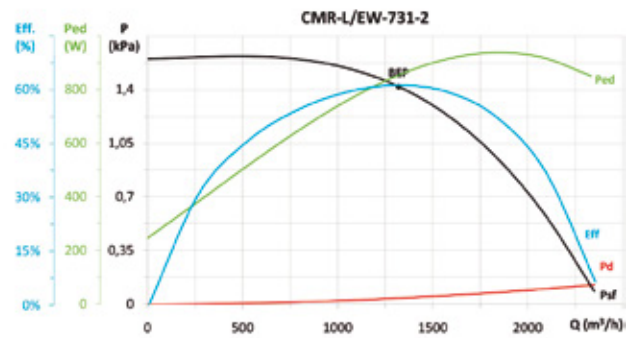

MC	EC	SR	Cc	η_b (%)*	N	[kW]	[m³/h]	[Pa]	[rpm]	VSD
A	S	1,01	1,09	66,9%	78,1	0,851	1320	1419	2850	INCLUDED

* η_e (%) = Eff. (%) x Cc

Accessories

See accessories section.



INT



RPA



B



BD



BIC



ACE



S



REG



CONTROL UNITS
AND SENSORS



EFFICIENT WORK



CMR/EW



**HIGHLY EFFICIENT
IE3-COMPLIANT
THREE-PHASE MOTORS**



VARIABLE SPEED DRIVE
VSD: Variable Speed Drive.
· VSD1/A-RFM
· VSD3/A-RFT
Supply on request

CONTROL
Supply optional accessory

SUPPLY
VSD1/A-RFM:
220-240 V 50/60 Hz
VSD3/A-RFT:
380-415 V 50/60 Hz

High-efficiency centrifugal single-inlet, medium-pressure fans with a direct motor and impeller with backward-facing blades fitted with IE3 asynchronous motor adjustable electronically.

Fan:

- Steel sheet casing
- Impeller with backward-curved blades made from robust sheet steel

Motor and electronic variable speed:

- Motors with IE3 efficiency adjustable electronically.
- The variable speed drive VSD will be supplied as per order.
- Electronic variable speed drive (VSD) can be adjusted by external 0-10 V signal.
- It is advisable to install sinusoidal filters between the fan and the electronic variable speed drive (VSD) when they are far apart.
- Electronic variable speed drive (VSD), available with single-phase 220-240 V 50/60 Hz input (VSD1/B type) or three-phase 380-415 V 50/60 Hz (VSD3/B type).
- By default, the electronic variable speed drive (VSD) is delivered programmed for constant speed.
- Working fan temperature:
-25 °C +120 °C.
- Working temperature (VSD):
-25 °C +50 °C.

- Class F motors with ball bearings, IP55 protection.
- Three-phase 230/400 V. 50 Hz. (up to 5.5 CV.) and 400/690 V 50 Hz. (power over 5.5 CV.)

Finish:

- Anticorrosive finish in polyester resin polymerised at 190°C, after alkaline degreasing with nanotechnology treatment and phosphate-free.

On request:

- Fan designed to transport air up to 250°C.
- Stainless steel fans

Fan order code

CMR/EW — 1031 — 2T — IE3

CMR/EW: High efficiency robust centrifugal single-inlet, medium-pressure fans fitted with an impeller with backward-facing blades, "Efficient work"

Impeller size

Number of motor poles:
2T=2900 r/min
4T=1440 r/min
6T=950 r/min

Three-phase motor IE3

CMR/EW — 1031 — 2T — IE3 — VSD1 — D

CMR/EW: High efficiency robust centrifugal single-inlet, medium-pressure fans fitted with an impeller with backward-facing blades, "Efficient work"

Impeller size

Number of motor poles:
2T=2900 r/min
4T=1440 r/min
6T=950 r/min

Three-phase motor IE3

VSD1: Fitted with VSD1/A-RFM, electronic variable speed, single phase power supply 220-240 V 50/60 Hz.

VSD3: Fitted with VSD3/A-RFT, electronic variable speed, three-phase power supply 380-415 V 50/60 Hz.

D: Standard version, VSD supplied programmed for constant speed.
P: Supplied with VSD programmed for pressure control and Si-Presión pressure transmitter
K: Supplied with VSD programmed for pressure control and built into a BOXPRES KIT/B box. Only available for fans with motor power less than or equal to 2.2 kW.

Technical characteristics

Model	Speed min/max (r/min)	Single-phase VSD 230 V 50/60 Hz		Three-phase VSD 400 V 50/60 Hz		Maximum Motor 50 Hz 690V			Installed power (kW)	Maximum airflow min/max (m³/h)	Sound pressure level min/max dB(A)	Weight approx. (Kg)
		Maximum current input (A)	Model VSD	Maximum current input (A)	Model VSD	230V	400V (A)	690V				
CMR/EW-1031-2T	1150/2875	16.15	VSD1/A-RFM-2	4.49	VSD3/A-RFT-2	5.34	3.07	-	1.50	2065 / 5160	60 / 80	44.3
CMR/EW-1135-2T	1165/2910	23.25	VSD1/A-RFM-3	6.46	VSD3/A-RFT-3	7.32	4.21	-	2.20	3125 / 7800	63 / 83	54.9
CMR/EW-1240-2T	1160/2900	-	-	9.44	VSD3/A-RFT-5.5	13.00	7.50	-	4.00	4440 / 11100	66 / 86	93.5
CMR/EW-1240-4T	570/1420	8.32	VSD1/A-RFM-1	2.31	VSD3/A-RFT-1	2.82	1.62	-	0.75	2330 / 5800	51 / 71	70.5
CMR/EW-1445-2T	1175/2935	-	-	17.45	VSD3/A-RFT-10	-	13.90	8.06	7.50	6605 / 16500	67 / 87	126.0
CMR/EW-1445-4T	580/1455	11.87	VSD1/A-RFM-2	3.30	VSD3/A-RFT-2	4.07	2.34	-	1.10	3200 / 8030	52 / 72	92.5
CMR/EW-1650-2T	1170/2925	-	-	25.48	VSD3/A-RFT-15	-	19.60	11.40	11.00	7540 / 18850	69 / 89	178.0
CMR/EW-1650-4T	575/1440	15.78	VSD1/A-RFM-2	4.38	VSD3/A-RFT-2	5.41	3.11	-	1.50	4195 / 10500	54 / 74	114.0
CMR/EW-1650-6T	375/940	8.69	VSD1/A-RFM-1	2.41	VSD3/A-RFT-1	3.36	1.93	-	0.75	2955 / 7410	44 / 64	114.0
CMR/EW-1856-4T	575/1440	-	-	7.20	VSD3/A-RFT-5.5	10.70	6.15	-	3.00	6050 / 15150	59 / 79	152.0
CMR/EW-1856-6T	380/945	12.43	VSD1/A-RFM-2	3.45	VSD3/A-RFT-2	4.68	2.69	-	1.10	4040 / 10050	50 / 70	146.5
CMR/EW-2063-4T	585/1465	-	-	12.81	VSD3/A-RFT-7.5	-	10.30	5.97	5.50	9765 / 24450	60 / 80	226.0
CMR/EW-2063-6T	380/950	16.64	VSD1/A-RFM-2	4.62	VSD3/A-RFT-2	6.43	3.70	-	1.50	6440 / 16100	51 / 71	208.5
CMR/EW-2271-4T	590/1470	-	-	25.10	VSD3/A-RFT-15	-	21.40	12.40	11.00	13890 / 34610	65 / 85	315.0
CMR/EW-2271-6T	390/970	-	-	7.39	VSD3/A-RFT-5.5	12.00	6.91	-	3.00	9145 / 22750	56 / 76	293.5
CMR/EW-2380-4T	590/1475	-	-	49.98	VSD3/A-RFT-30	-	40.60	23.50	22.00	19200 / 48000	63 / 83	416.0
CMR/EW-2380-6T	390/970	-	-	17.59	VSD3/A-RFT-10	-	14.80	8.58	7.50	12060 / 30000	55 / 75	363.0

Acoustic features at maximum speed

The specified values are determined according to free field measurements of sound levels in dB(A) at an equivalent distance of twice the fan's span plus the impeller's diameter, with a minimum of 1.5 m.

Sound power Lw(A) spectrum in dB(A) via frequency band in Hz.

Model	63	125	250	500	1000	2000	4000	8000	Model	63	125	250	500	1000	2000	4000	8000
CMR/EW-1031-2T	65	78	78	91	86	86	86	79	CMR/EW-1856-4T	69	78	91	87	90	91	85	71
CMR/EW-1135-2T	72	79	77	89	87	93	92	79	CMR/EW-1856-6T	61	69	81	83	80	81	71	60
CMR/EW-1240-2T	68	83	81	93	90	94	96	83	CMR/EW-2063-4T	80	85	91	93	91	88	81	73
CMR/EW-1240-4T	56	70	76	79	79	80	70	59	CMR/EW-2063-6T	69	70	82	82	81	83	73	63
CMR/EW-1445-2T	73	85	83	95	93	97	99	89	CMR/EW-2271-4T	83	84	93	96	98	99	95	82
CMR/EW-1445-4T	59	72	78	83	80	83	78	64	CMR/EW-2271-6T	73	73	87	86	90	90	79	68
CMR/EW-1650-2T	73	81	85	99	97	99	99	88	CMR/EW-2380-4T	76	78	94	91	96	97	93	82
CMR/EW-1650-4T	64	74	82	84	83	85	76	66	CMR/EW-2380-6T	68	70	86	83	88	89	85	74
CMR/EW-1650-6T	53	65	72	77	73	69	62	54									

Dimensions in mm

CMR/EW-1031...2271

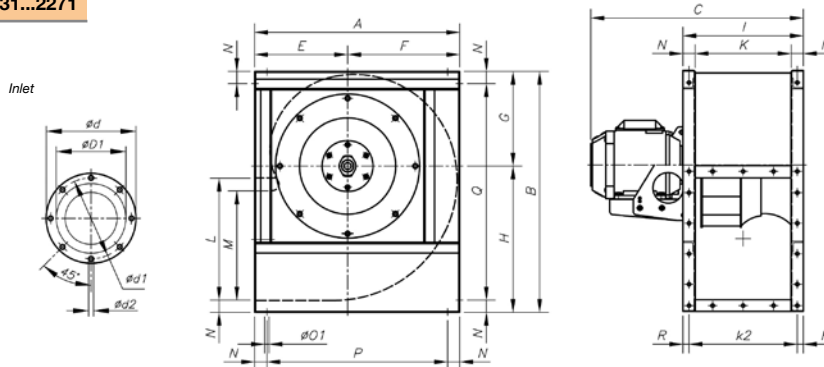

Model	A	B	C	øD1*	ød	ød1	ød2	E	F	G	H	I	K	k2	L	M	N	øO1	P	Q	R
CMR/EW-1031-2T	542	626	567	315	383	356	M8	250	292	245	381	320	250	285	315	276	35	11	472	556	17.5
CMR/EW-1135-2T	600	696	583	355	425	398	M8	275	325	273	423	350	280	315	355	310	35	11	530	626	17.5
CMR/EW-1240-2T	673	790	728	400	472	444	M10	305	368	310	480	395	315	355	400	358	40	11	593	710	20
CMR/EW-1240-4T	673	790	590	400	472	444	M10	305	368	310	480	395	315	355	400	358	40	11	593	710	20
CMR/EW-1445-2T	765	880	810	450	522	494	M10	350	415	339	541	445	355	405	450	404	45	11	675	790	20
CMR/EW-1445-4T	765	880	649	450	522	494	M10	350	415	339	541	445	355	405	450	404	45	11	675	790	20
CMR/EW-1650-2T	832	970	961	500	582	555	M10	375	457	378	592	490	400	450	500	445	45	13	742	880	20
CMR/EW-1650-4T	832	970	715	500	582	555	M10	375	457	378	592	490	400	450	500	445	45	13	742	880	20
CMR/EW-1650-6T	832	970	695	500	582	555	M10	375	457	378	592	490	400	450	500	445	45	13	742	880	20
CMR/EW-1856-4T	925	1084	832	560	645	615	M10	415	510	426	658	550	450	500	560	493	50	13	825	984	25
CMR/EW-1856-6T	925	1084	771	560	645	615	M10	415	510	426	658	550	450	500	560	493	50	13	825	984	25
CMR/EW-2063-4T	1037	1218	973	630	720	688	M10	465	572	477	741	620	500	560	630	530	60	13	917	1098	30
CMR/EW-2063-6T	1037	1218	893	630	720	688	M10	465	572	477	741	620	500	560	630	530	60	13	917	1098	30
CMR/EW-2271-4T	1173	1375	1126	710	800	768	M12	525	648	538	837	690	560	625	710	603	65	13	1043	1245	32.5
CMR/EW-2271-6T	1173	1375	1039	710	800	768	M12	525	648	538	837	690	560	625	710	603	65	13	1043	1245	32.5



EFFICIENT WORK



Dimensions in mm

CMR/EW-2380

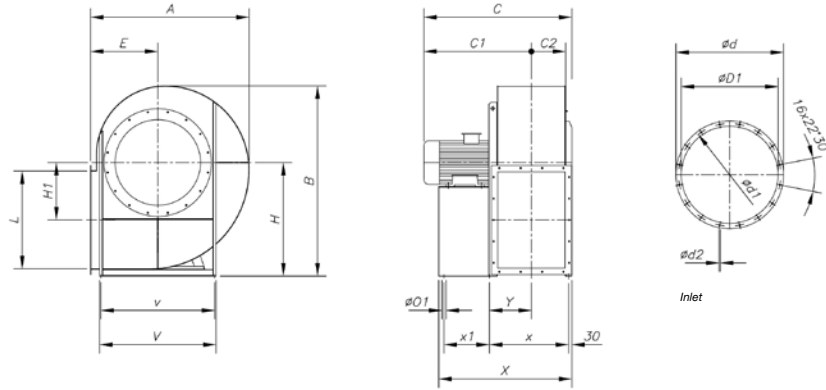

Model	A	B	C	C1	C2	øD1*	ød	ød1	ød2	E	H	H1	L	øO1	V	v	X	x	x1	Y
CMR/EW-2380-4T	1350	1660	1245	899	286	808	906	861	11.5	560	1000	500	800	17	930	870	1102.5	667.5	370	352.5
CMR/EW-2380-6T	1350	1660	1030	744	286	808	906	861	11.5	56	1000	500	800	17	930	870	1102.5	667.5	370	352.5

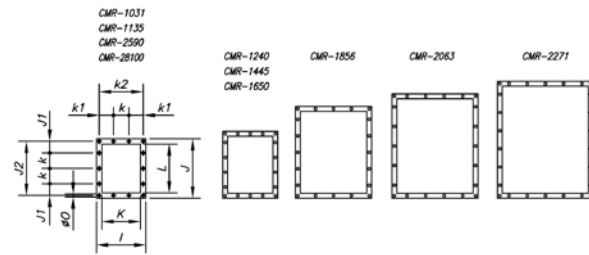

Outlet

Model	I	J	J1	J2	K	k	k1	k2	L	øO
CMR/EW-1031	320	385	75	350	250	100	92.5	285	315	11
CMR/EW-1135	350	425	95	390	280	100	107.5	315	355	11
CMR/EW-1240	395	480	70	440	315	100	77.5	355	400	11
CMR/EW-1445	445	540	99	498	355	100	102.5	405	450	11
CMR/EW-1650	490	590	87.5	550	400	125	100	450	500	13
CMR/EW-1856	550	660	55	610	450	125	125	500	560	13
CMR/EW-2063	620	750	95	690	500	125	92.5	560	630	13
CMR/EW-2271	690	840	75	775	560	125	62.5	625	710	13
CMR/EW-2380	680	920	160	871	560	200	140	639	800	14

Positions

LG 270 standard supply

Models 2380, 2590 and 28100 fixed positions LG 270 (other positions on request only)

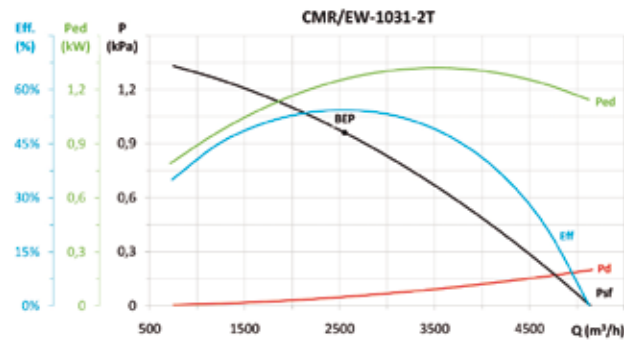

Erp. Characteristic curves and ErP data

MC	EC	SR	Cc	η_e (%)*	N	[kW]	[m³/h]	[Pa]	[rpm]	VSD
A	S	1,01	1,08	58,8%	68,2	1,254	2553	961,3	2916	NECESSARY

* η_e (%) = Eff. (%) x Cc

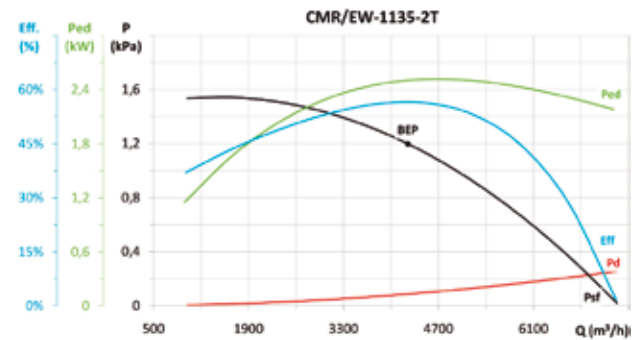

MC	EC	SR	Cc	η_e (%)*	N	[kW]	[m³/h]	[Pa]	[rpm]	VSD
A	S	1,01	1,06	60,0%	66,3	2,500	4249	1198,6	2916	NECESSARY

* η_e (%) = Eff. (%) x Cc

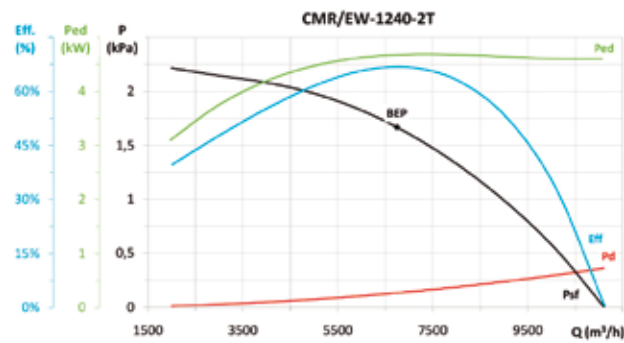

MC	EC	SR	Cc	η_e (%)*	N	[kW]	[m³/h]	[Pa]	[rpm]	VSD
A	S	1,02	1,04	69,6%	73,1	4,675	6744	1667,2	2901	NECESSARY

* η_e (%) = Eff. (%) x Cc

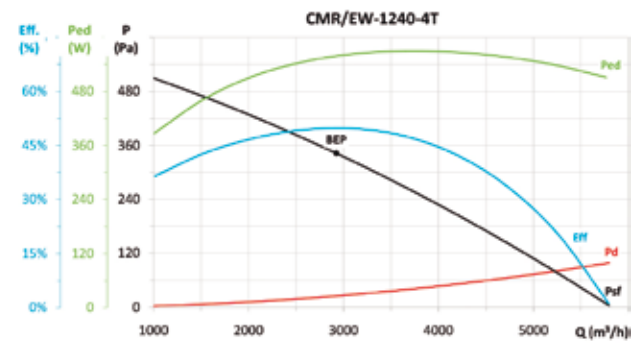

MC	EC	SR	Cc	η_e (%)*	N	[kW]	[m³/h]	[Pa]	[rpm]	VSD
A	S	1,00	1,11	55,1%	68,2	0,558	2924	342,3	1453	NECESSARY

* η_e (%) = Eff. (%) x Cc

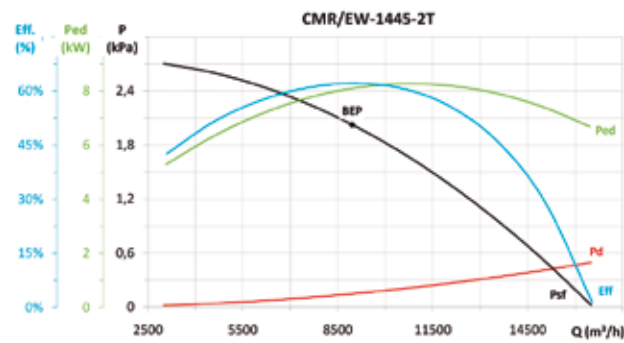

MC	EC	SR	Cc	η_e (%)*	N	[kW]	[m³/h]	[Pa]	[rpm]	VSD
A	S	1,02	1,04	64,6%	65,6	8,103	8951	2025,7	2939	NECESSARY

* η_e (%) = Eff. (%) x Cc

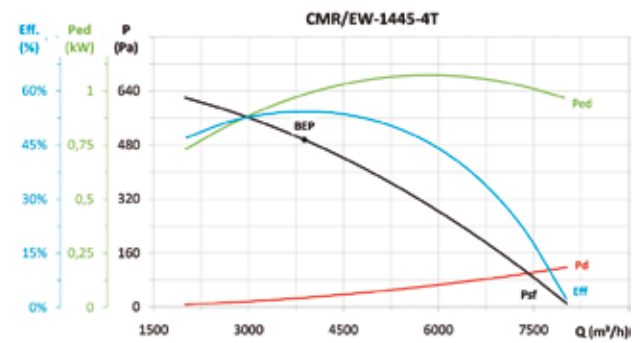

MC	EC	SR	Cc	η_e (%)*	N	[kW]	[m³/h]	[Pa]	[rpm]	VSD
A	S	1,01	1,09	59,1%	69,7	0,983	3883	495,3	1468	NECESSARY

* η_e (%) = Eff. (%) x Cc

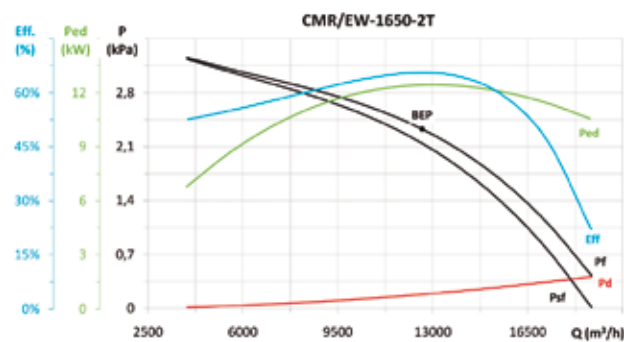

MC	EC	SR	Cc	η_e (%)*	N	[kW]	[m³/h]	[Pa]	[rpm]	VSD
B	T	1,02	1,04	68,2%	68,0	12,431	12602	2328,0	2927	NECESSARY

* η_e (%) = Eff. (%) x Cc

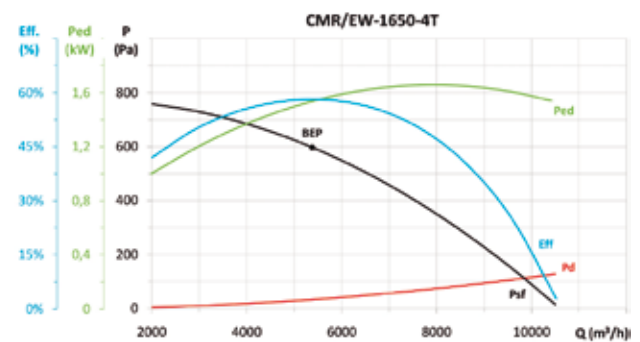

MC	EC	SR	Cc	η_e (%)*	N	[kW]	[m³/h]	[Pa]	[rpm]	VSD
A	S	1,01	1,08	62,5%	71,1	1,535	5378	597,4	1449	NECESSARY

* η_e (%) = Eff. (%) x Cc



EFFICIENT WORK



Erp. Characteristic curves and ErP data

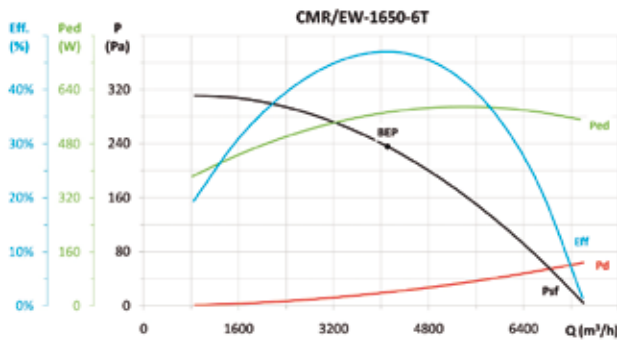

MC	EC	SR	Cc	η_e (%)*	N	[kW]	[m³/h]	[Pa]	[rpm]	VSD
A	S	1,00	1,10	52,0%	65,0	0,572	4109	235,7	966	NECESSARY

* η_e (%) = Eff. (%) x Cc

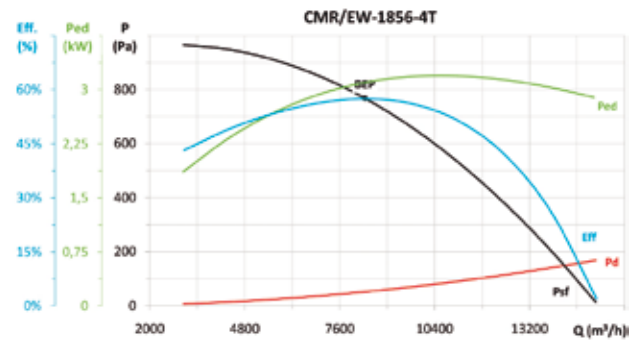

MC	EC	SR	Cc	η_e (%)*	N	[kW]	[m³/h]	[Pa]	[rpm]	VSD
A	S	1,01	1,05	60,6%	65,9	3,096	8342	768,0	1448	NECESSARY

* η_e (%) = Eff. (%) x Cc

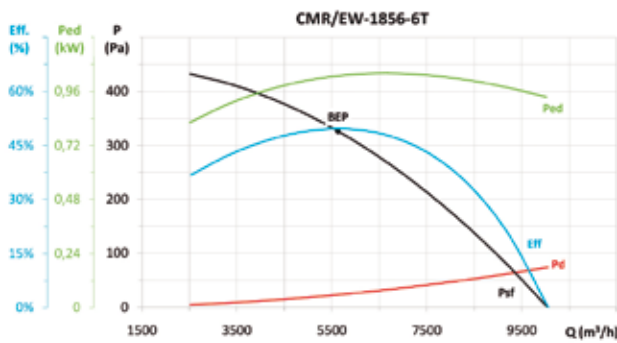

MC	EC	SR	Cc	η_e (%)*	N	[kW]	[m³/h]	[Pa]	[rpm]	VSD
A	S	1,00	1,09	53,9%	64,3	1,028	5632	326,1	960	NECESSARY

* η_e (%) = Eff. (%) x Cc

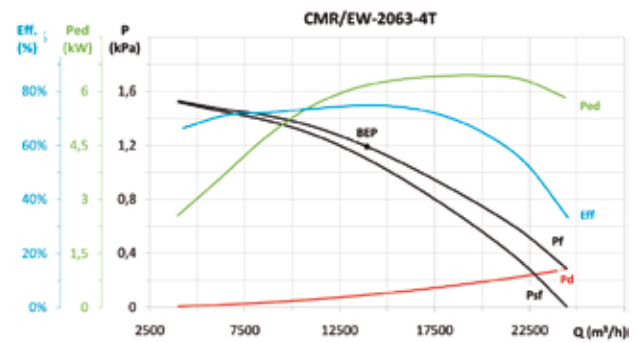

MC	EC	SR	Cc	η_e (%)*	N	[kW]	[m³/h]	[Pa]	[rpm]	VSD
B	T	1,01	1,04	77,8%	80,0	6,161	13932	1190,7	1466	NECESSARY

* η_e (%) = Eff. (%) x Cc

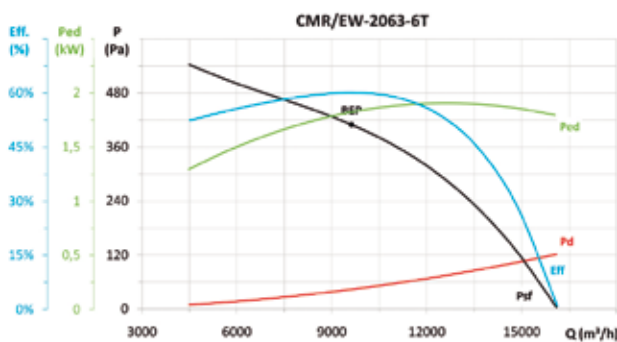

MC	EC	SR	Cc	η_e (%)*	N	[kW]	[m³/h]	[Pa]	[rpm]	VSD
A	S	1,00	1,07	64,3%	72,1	1,822	9620	409,7	952	NECESSARY

* η_e (%) = Eff. (%) x Cc

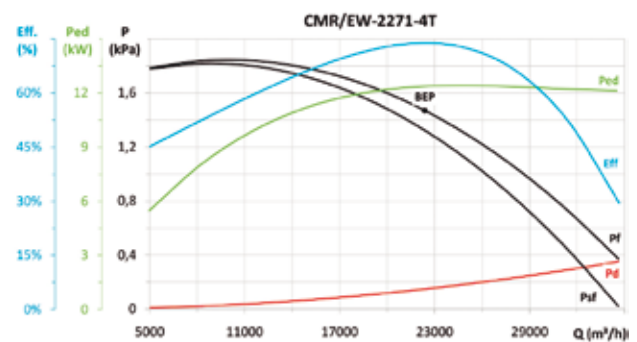

MC	EC	SR	Cc	η_e (%)*	N	[kW]	[m³/h]	[Pa]	[rpm]	VSD
B	T	1,01	1,04	76,8%	76,7	12,369	22380	1469,6	1470	NECESSARY

* η_e (%) = Eff. (%) x Cc

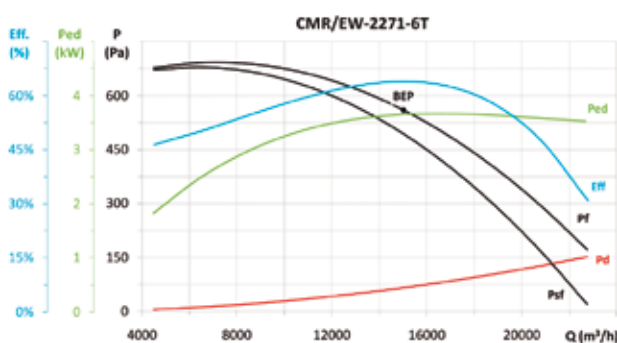

MC	EC	SR	Cc	η_e (%)*	N	[kW]	[m³/h]	[Pa]	[rpm]	VSD
B	T	1,01	1,05	67,1%	71,7	3,654	15016	560,2	970	NECESSARY

* η_e (%) = Eff. (%) x Cc

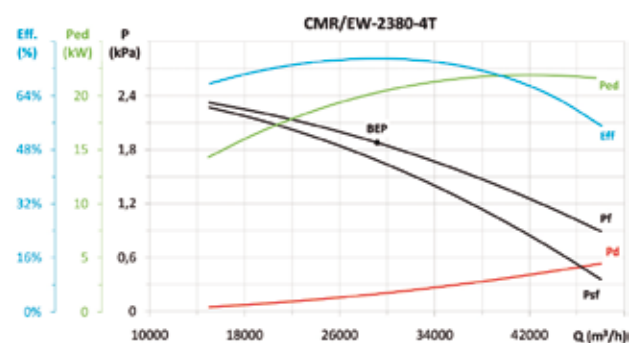

MC	EC	SR	Cc	η_e (%)*	N	[kW]	[m³/h]	[Pa]	[rpm]	VSD
B	T	1,02	1,04	78,0%	77,3	20,266	29151	1877,3	1480	NECESSARY

* η_e (%) = Eff. (%) x Cc



Erp. Characteristic curves and ErP data

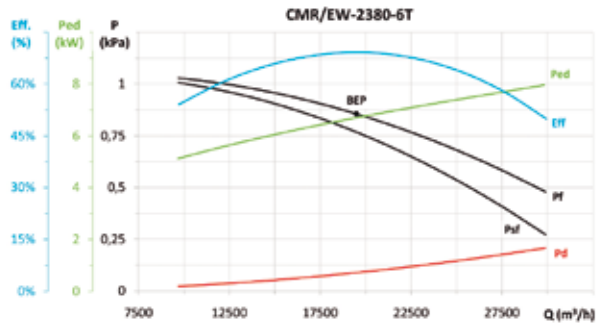

MC	EC	SR	Cc	η_e (%)*	N	[kW]	[m³/h]	[Pa]	[rpm]	VSD
B	T	1,01	1,04	72,0%	73,8	6,696	19494	855,7	977	NECESSARY

* η_e (%) = Eff. (%) x Cc

Accessories

See accessories section.





EFFICIENT WORK



CAS-L/EW



INDUSTRIAL BRUSHLESS MOTOR E.C.



Centrifugal single-inlet, high-pressure fans with sheet steel casing and aluminium impeller fitted with industrial BRUSHLESS motor E.C.

Fan:

- Steel sheet casing
- Impeller with backward-facing blades made from cast aluminium.
- Electronic variable speed (VSD), three-phase or single-phase, is supplied with fan.

Motor and electronic variable speed:

- High-efficiency Industrial Brushless Motors E.C., fitted with electronic variable speed (VSD), adjustable via external control input 0-10V.
 - It is advisable to install an electronic variable speed drive (VSD) outside the working area.
 - The external signal can be supplied through a manual or automatic control with 0-10 V output.
 - Electronic variable speed drive (VSD), available with single-phase 220-240 V 50/60 Hz input (VSD1/B type) or three-phase 380-415 V 50/60 Hz (VSD3/B type).
- Working fan temperature: -25 °C +120°C.
 - Working temperature (VSD): -25 °C +50 °C.

Finish:

- Anticorrosive finish in polyester resin polymerised at 190°C, after alkaline degreasing with nanotechnology treatment and phosphate-free.

On request:

- Fan designed to transport air up to 250°C.
- Stainless steel fans
- Acoustic silencer at inlet.

Order code with variable speed drive (VSD) included

CAS-L/EW — 242 — 2 — 0.33 — B — T — D

CAS-L/EW: High-efficiency centrifugal single-inlet, high-pressure fans with sheet steel and aluminium impeller, "Efficient work"

Impeller size

Number of motor poles: 2=2850 r/min

Motor power (CV)

Industrial Brushless Motors E.C.

M: Fitted with VSD1/B, electronic variable speed, single phase power supply 220-240 V 50/60 Hz.

T: Fitted with VSD3/B, electronic variable speed, three-phase power supply 380-415 V 50/60 Hz.

D: Standard version, VSD supplied programmed for constant speed.

P: Supplied with VSD programmed for pressure control and Si-PreSi3n pressure transmitter
K: Supplied with VSD programmed for pressure control and built into a BOXPRES KIT/B box.

Technical characteristics

Model	Speed min/max (r/min)	Single-phase VSD 230 V 50/60 Hz		Three-phase VSD 400 V 50/60 Hz		Maximum electrical power (W)	Maximum airflow min/max (m³/h)	Sound pressure level min/max dB(A)	Weight approx. (Kg)
		Maximum current input (A)	Model VSD	Maximum current input (A)	Model VSD				
CAS-L/EW-242-2-0.33	300 / 2850	2.86	VSD1/B-0.37	0.84	VSD3/B-0.75	345	45 / 450	24 / 73	30.0
CAS-L/EW-242-2-0.5	300 / 2850	4.08	VSD1/B-0.37	1.20	VSD3/B-0.75	495	70 / 650	24 / 73	31.0
CAS-L/EW-248-2-0.75	300 / 2850	5.99	VSD1/B-0.37	1.76	VSD3/B-0.75	730	45 / 420	25 / 74	43.5
CAS-L/EW-248-2-1	300 / 2850	8.15	VSD1/B-0.75	1.92	VSD3/B-0.75	925	55 / 500	26 / 75	45.0
CAS-L/EW-248-2-1.5	300 / 2850	11.80	VSD1/B-0.75	2.78	VSD3/B-1.5	1345	105 / 990	27 / 76	46.5
CAS-L/EW-254-2-1.5	300 / 2850	11.80	VSD1/B-0.75	2.78	VSD3/B-1.5	1345	65 / 600	27 / 76	56.5
CAS-L/EW-254-2-2	300 / 2850	15.89	VSD1/B-1.5	3.74	VSD3/B-1.5	1810	85 / 800	29 / 78	61.5
CAS-L/EW-254-2-3	300 / 2850	23.11	VSD1/B-2.2	5.45	VSD3/B-2.2	2630	135 / 1300	31 / 80	63.0
CAS-L/EW-260-2-3	300 / 2850	23.11	VSD1/B-2.2	5.45	VSD3/B-2.2	2630	95 / 900	30 / 79	78.0



Acoustic features at maximum speed

The specified values are determined according to free field measurements of sound levels in dB(A) at an equivalent distance of twice the fan's span plus the impeller's diameter, with a minimum of 1.5 m.

Sound power Lw(A) spectrum in dB(A) via frequency band in Hz.

Model	63	125	250	500	1000	2000	4000	8000	Model	63	125	250	500	1000	2000	4000	8000
242-2-0,33	50	61	67	76	83	82	79	72	254-2-1,5	55	66	71	81	88	87	84	77
242-2-0,5	50	61	67	76	83	82	79	72	254-2-2	57	68	73	83	90	89	86	79
248-2-0,75	51	62	68	77	84	83	80	73	254-2-3	56	68	76	85	90	92	89	82
248-2-1	52	63	69	78	85	84	81	74	260-2-2	53	69	69	83	88	88	85	78
248-2-1,5	53	64	70	79	86	85	82	75	260-2-3	55	71	71	85	90	90	87	80

Dimensions in mm

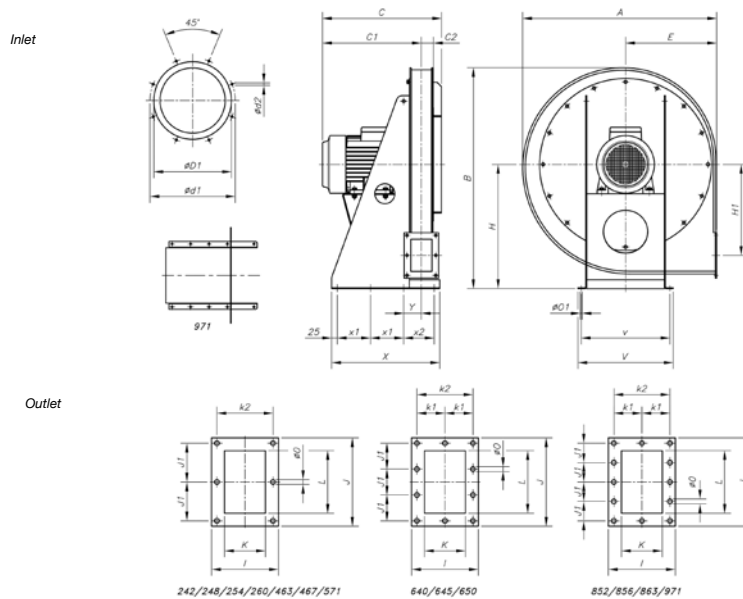

Model	A	B	C	C1	C2	øD1	ød1	ød2	E	H	H1	I	J	J1	K	k1	k2	L	øO	øO1	V	v	X	x1	x2	Y
CAS-L/EW-242-2-0.33	576	662	282	219	33	100	130	M8	270	375	270	120	155	65	60	-	95	95	11	12	305	275	260	75	-	61
CAS-L/EW-242-2-0.5	576	662	310	247	33	100	130	M8	270	375	270	120	155	65	60	-	95	95	11	12	305	275	260	75	-	61
CAS-L/EW-248-2-0.75	639	728	315	249	36	112	140	M8	300	410	297	126	165	70	66	-	101	105	11	12	320	290	300	90	-	64
CAS-L/EW-248-2-1	639	728	340	274	36	112	140	M8	300	410	297	126	165	70	66	-	101	105	11	12	320	290	300	90	-	64
CAS-L/EW-248-2-1.5	639	728	340	274	36	112	140	M8	300	410	297	126	165	70	66	-	101	105	11	12	320	290	300	90	-	64
CAS-L/EW-254-2-1.5	699	788	365	294.5	40.5	125	155	M8	330	440	322	135	175	75	75	-	110	115	11	14	340	310	330	100	-	68.5
CAS-L/EW-254-2-2	699	788	413	342.5	40.5	125	155	M8	330	440	322	135	175	75	75	-	110	115	11	14	340	310	330	100	-	68.5
CAS-L/EW-254-2-3	699	788	443	372.5	40.5	125	155	M8	330	440	322	135	175	75	75	-	110	115	11	14	340	310	330	100	-	68.5
CAS-L/EW-260-2-3	782	875	419	343.5	47.5	150	175	M8	370	485	362	145	185	80	85	-	120	125	11	14	380	350	370	115	-	73.5

Positions

LG 270 standard supply
 LG 180 positions on request
 and with special fixing measurements.



Supplied on request
 RD 180 positions with special
 fixing measurements.





EFFICIENT WORK



Erp. Characteristic curves and ErP data

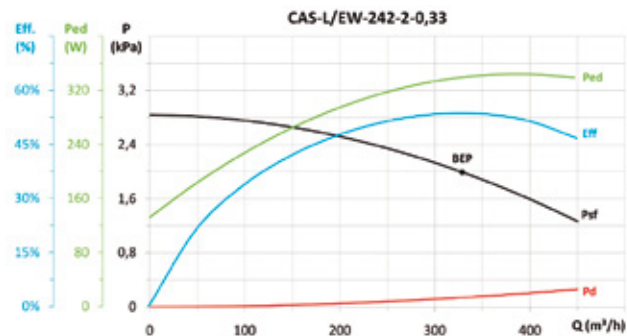

MC	EC	SR	Cc	η_b (%)*	N	[kW]	[m³/h]	[Pa]	[rpm]	VSD
A	S	1,02	1,12	60,1%	75,6	0,339	329	1992	2850	INCLUDED

* η_e (%) = Eff. (%) x Cc

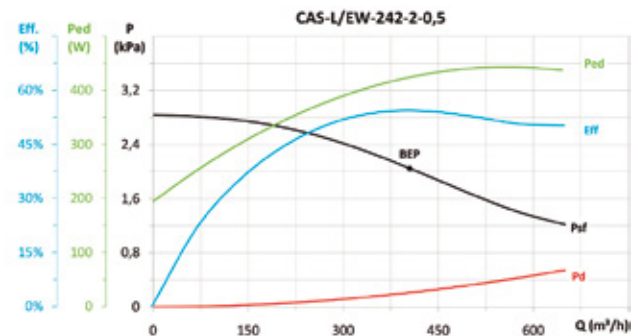

MC	EC	SR	Cc	η_b (%)*	N	[kW]	[m³/h]	[Pa]	[rpm]	VSD
A	S	1,02	1,11	60,6%	75,0	0,423	405	2049	2850	INCLUDED

* η_e (%) = Eff. (%) x Cc

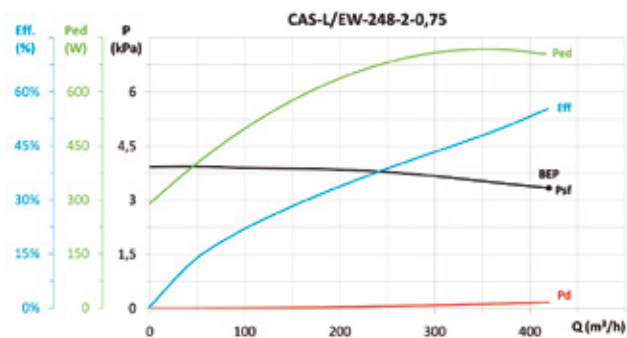

MC	EC	SR	Cc	η_b (%)*	N	[kW]	[m³/h]	[Pa]	[rpm]	VSD
A	S	1,03	1,10	60,7%	72,8	0,704	420	3337,1	2850	INCLUDED

* η_e (%) = Eff. (%) x Cc

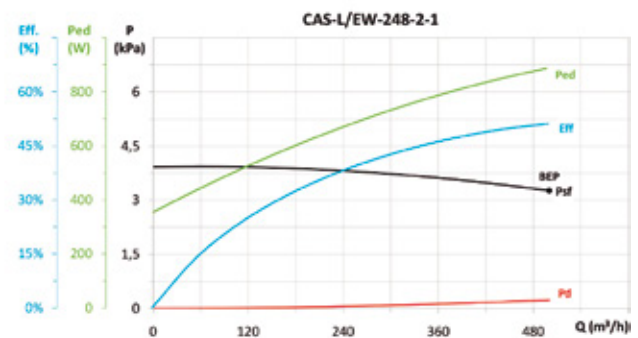

MC	EC	SR	Cc	η_b (%)*	N	[kW]	[m³/h]	[Pa]	[rpm]	VSD
A	S	1,03	1,09	55,8%	66,9	0,886	500	3263,7	2850	INCLUDED

* η_e (%) = Eff. (%) x Cc

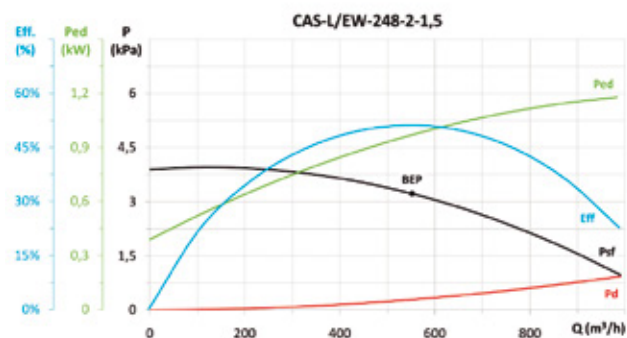

MC	EC	SR	Cc	η_b (%)*	N	[kW]	[m³/h]	[Pa]	[rpm]	VSD
A	S	1,03	1,09	55,7%	66,3	0,966	552	3224,0	2850	INCLUDED

* η_e (%) = Eff. (%) x Cc

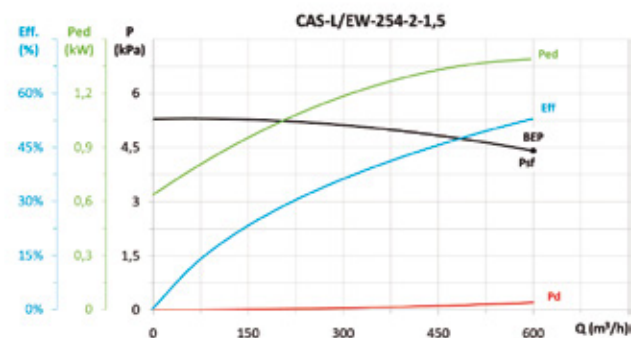

MC	EC	SR	Cc	η_b (%)*	N	[kW]	[m³/h]	[Pa]	[rpm]	VSD
A	S	1,05	1,08	57,0%	66,0	1,390	600	4411,5	2850	INCLUDED

* η_e (%) = Eff. (%) x Cc

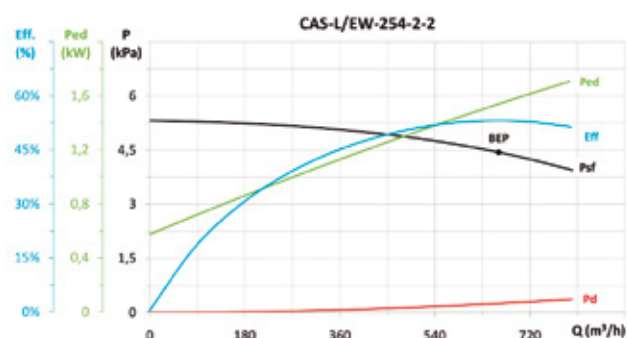

MC	EC	SR	Cc	η_b (%)*	N	[kW]	[m³/h]	[Pa]	[rpm]	VSD
A	S	1,05	1,08	57,1%	65,7	1,534	661	4437,9	2850	INCLUDED

* η_e (%) = Eff. (%) x Cc

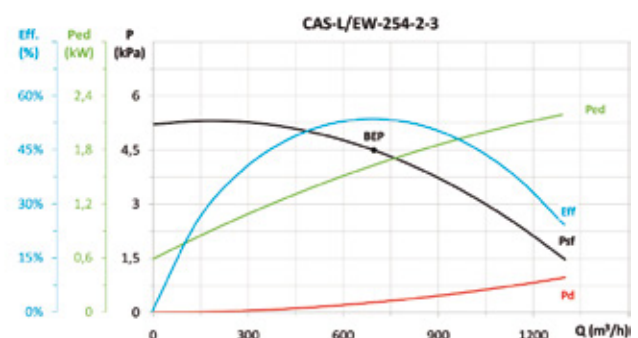

MC	EC	SR	Cc	η_b (%)*	N	[kW]	[m³/h]	[Pa]	[rpm]	VSD
A	S	1,05	1,07	57,5%	65,8	1,624	697	4497,5	2850	INCLUDED

* η_e (%) = Eff. (%) x Cc



Erp. Characteristic curves and ErP data

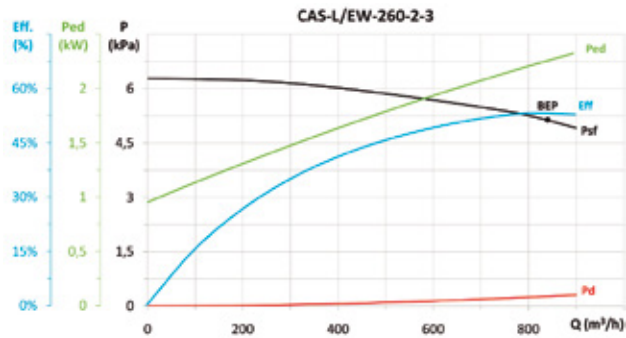

MC	EC	SR	Cc	η_a [%]*	N	[kW]	[m³/h]	[Pa]	[rpm]	VSD
A	S	1,05	1,06	56,7%	63,5	2,250	840	5140,6	2850	INCLUDED

* η_e (%) = Eff. (%) x Cc

Accessories

See accessories section.



CAS/EW



**HIGHLY EFFICIENT
IE3-COMPLIANT
THREE-PHASE MOTORS**



VARIABLE SPEED DRIVE
VSD: Variable Speed Drive.
· VSD1/A-RFM
· VSD3/A-RFT
Supply on request

CONTROL
Supply optional accessory

SUPPLY
VSD1/A-RFM:
220-240 V 50/60 Hz
VSD3/A-RFT:
380-415 V 50/60 Hz

High-efficiency centrifugal single-inlet, high-pressure fans with casing and sheet steel impeller, fitted with IE3 asynchronous motor adjustable electronically.

Fan:

- Steel sheet casing
- Impeller with backward-facing blades made from galvanised sheet steel, except models 640, 645 and 650 which have a cast aluminium impeller.

Motor and electronic variable speed:

- Motors with IE3 efficiency adjustable electronically.
- The variable speed drive VSD will be supplied as per order.
- Electronic variable speed drive (VSD) can be adjusted by external 0-10 V signal.
- It is advisable to install sinusoidal filters between the fan and the electronic variable speed drive (VSD) when they are far apart.
- Electronic variable speed drive (VSD), available with single-phase 220-240 V 50/60 Hz input (VSD1/B type) or three-phase 380-415 V 50/60 Hz (VSD3/B type).
- By default, the electronic variable speed drive (VSD) is delivered programmed for constant speed.
- Working fan temperature:
-25 °C +120 °C.
- Working temperature (VSD):
-25 °C +50 °C.

- Class F motors with ball bearings, IP55 protection.

- Three-phase 230/400 V. 50 Hz. (up to c) and 400/690 V. 50 Hz. (power over 5.5 CV)

Finish:

- Anticorrosive finish in polyester resin polymerised at 190°C, after alkaline degreasing with nanotechnology treatment and phosphate-free.

On request:

- Fan designed to transport air up to 250°C.
- Stainless steel fans

Fan order code

CAS/EW — 463 — 2T — 5.5 — IE3

CAS/EW: High-efficiency centrifugal single-inlet, high-pressure fans with casing and sheet steel impeller, "Efficient work"

Impeller size

Number of motor poles:
2=2850 r/min

Motor power (CV)

Three-phase motor IE3

CAS/EW — 463 — 2T — 5.5 — IE3 — VSD1 — D

CAS/EW: High-efficiency centrifugal single-inlet, high-pressure fans with casing and sheet steel impeller, "Efficient work"

Impeller size

Number of motor poles:
2=2850 r/min

Motor power (CV)

Three-phase motor IE3

VSD1: Fitted with VSD1/A-RFM, electronic variable speed, single phase power supply 220-240 V 50/60 Hz.

VSD3: Fitted with VSD3/A-RFT, electronic variable speed, three-phase power supply 380-415 V 50/60 Hz.

D: Standard version, VSD supplied programmed for constant speed.
P: Supplied with VSD programmed for pressure control and Si-Presión pressure transmitter
K: Supplied with VSD programmed for pressure control and built into a BOXPRES KIT/B box. Only available for fans with motor power less than or equal to 2.2 kW.

Technical characteristics

Model	Speed min/max (r/min)	Single-phase VSD 230 V 50/60 Hz		Three-phase VSD 400 V 50/60 Hz		Maximum current Motor 50 Hz			Installed power (kW)	Maximum airflow min/max (m³/h)	Sound pressure level min/max dB(A)	Weight approx. (Kg)
		Maximum current input (A)	Model VSD	Maximum current input (A)	Model VSD	230V	400V (A)	690V				
CAS/EW-463-2T-5.5	1160/2900	-	-	9.44	VSD3/A-RFT-5.5	13.00	7.50	-	4.00	460 / 1150	62 / 82	57
CAS/EW-463-2T-7.5	1170/2930	-	-	12.91	VSD3/A-RFT-7.5	-	10.10	5.86	5.50	800 / 2000	63 / 83	58
CAS/EW-467-2T-7.5	1170/2930	-	-	12.91	VSD3/A-RFT-7.5	-	10.10	5.86	5.50	620 / 1550	64 / 84	69
CAS/EW-467-2T-10	1175/2935	-	-	17.45	VSD3/A-RFT-10	-	13.90	8.06	7.50	1040 / 2600	65 / 85	70
CAS/EW-571-2T-10	1175/2935	-	-	17.45	VSD3/A-RFT-10	-	13.90	8.06	7.50	800 / 2000	66 / 86	64
CAS/EW-571-2T-15	1170/2925	-	-	25.48	VSD3/A-RFT-15	-	19.60	11.40	11.00	1380 / 3450	67 / 87	65
CAS/EW-640-2T-2	1150/2875	16.15	VSD1/A-RFM-2	4.49	VSD3/A-RFT-2	5.34	3.07	-	1.50	1040 / 2600	57 / 77	56
CAS/EW-645-2T-3	1165/2910	23.25	VSD1/A-RFM-3	6.46	VSD3/A-RFT-3	7.32	4.21	-	2.20	800 / 2000	56 / 76	55
CAS/EW-645-2T-4	1165/2910	-	-	7.27	VSD3/A-RFT-5.5	10.00	5.77	-	3.00	1200 / 3000	61 / 81	55
CAS/EW-650-2T-5.5	1160/2900	-	-	9.44	VSD3/A-RFT-5.5	13.00	7.50	-	4.00	1400 / 3500	61 / 81	59
CAS/EW-650-2T-7.5	1170/2930	-	-	12.91	VSD3/A-RFT-7.5	-	10.10	5.86	5.50	1895 / 4750	63 / 83	52
CAS/EW-852-2T-7.5	1170/2930	-	-	12.91	VSD3/A-RFT-7.5	-	10.10	5.86	5.50	1400 / 3500	61 / 81	68
CAS/EW-852-2T-10	1175/2935	-	-	17.45	VSD3/A-RFT-10	-	13.90	8.06	7.50	2200 / 5500	65 / 85	68
CAS/EW-856-2T-15	1170/2925	-	-	25.48	VSD3/A-RFT-15	-	19.60	11.40	11.00	3000 / 7500	65 / 85	63
CAS/EW-863-2T-15	1170/2925	-	-	25.48	VSD3/A-RFT-15	-	19.60	11.40	11.00	1600 / 4000	64 / 84	67
CAS/EW-863-2T-20	1180/2945	-	-	33.97	VSD3/A-RFT-20	-	27.60	16.00	15.00	2805 / 7000	66 / 86	69
CAS/EW-971-2T-25	1180/2945	-	-	41.67	VSD3/A-RFT-25	-	33.50	19.40	18.50	2325 / 5800	67 / 87	67
CAS/EW-971-2T-30	1180/2955	-	-	49.39	VSD3/A-RFT-30	-	38.80	22.50	22.00	3235 / 8100	68 / 88	68
CAS/EW-1250-2T-15/A	1170/2925	-	-	25.48	VSD3/A-RFT-15	-	19.60	11.40	11.00	4800 / 12000	64 / 84	75
CAS/EW-1456-2T-25/A	1180/2945	-	-	41.67	VSD3/A-RFT-25	-	33.50	19.40	18.50	7210 / 18000	67 / 87	80
CAS/EW-790-2T-20	1180/2945	-	-	33.97	VSD3/A-RFT-20	-	27.60	16.00	15.00	840 / 2100	68 / 88	73
CAS/EW-980-2T-30	1180/2955	-	-	49.39	VSD3/A-RFT-30	-	38.80	22.50	22.00	1915 / 4800	67 / 87	61

Acoustic features at maximum speed

The specified values are determined according to free field measurements of sound levels in dB(A) at an equivalent distance of twice the fan's span plus the impeller's diameter, with a minimum of 1.5 m.

Sound power Lw(A) spectrum in dB(A) via frequency band in Hz.

Model	63	125	250	500	1000	2000	4000	8000	Model	63	125	250	500	1000	2000	4000	8000
CAS/EW-463-2-5.5	57	69	82	91	93	93	89	80	CAS/EW-852-2-7.5	68	72	82	88	92	92	89	84
CAS/EW-463-2-7.5	58	70	83	92	94	94	90	81	CAS/EW-852-2-10	68	76	86	93	96	96	92	84
CAS/EW-467-2-7.5	69	74	83	95	95	97	93	85	CAS/EW-856-2-15	63	76	90	96	96	94	90	84
CAS/EW-467-2-10	70	75	84	96	96	98	94	86	CAS/EW-863-2-15	67	81	87	96	96	95	92	87
CAS/EW-571-2-10	64	76	86	96	99	99	94	86	CAS/EW-863-2-20	69	81	92	99	98	95	93	87
CAS/EW-571-2-15	65	77	87	97	100	100	95	87	CAS/EW-971-2-25	67	81	90	102	98	96	93	89
CAS/EW-640-2-2	56	67	75	82	88	84	83	76	CAS/EW-971-2-30	68	82	91	103	99	97	94	90
CAS/EW-645-2-3	55	66	74	81	87	83	82	75	CAS/EW-1250-2-15/A	75	88	97	94	91	86	82	73
CAS/EW-645-2-4	55	66	77	86	90	91	87	79	CAS/EW-1456-2-25/A	80	93	102	99	96	90	87	78
CAS/EW-650-2-5.5	59	75	84	90	93	90	85	78	CAS/EW-790-2-20	73	77	88	99	105	96	89	83
CAS/EW-650-2-7.5	52	68	81	91	96	93	85	78	CAS/EW-980-2-30	61	70	76	91	105	97	94	90

Positions

LG 270 standard supply
LG 180 positions on request
and with special fixing measurements.



Supplied on request
RD 180 positions with special
fixing measurements.





EFFICIENT WORK



Dimensions in mm

CAS/EW-463...971

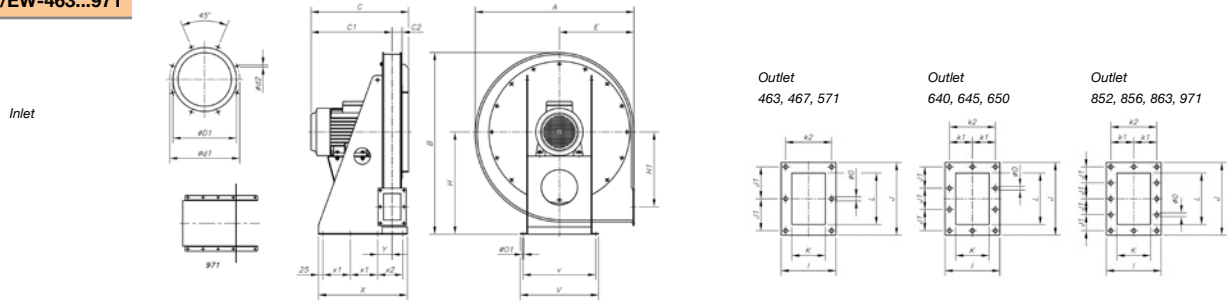

Model	A	B	C	C1	$\phi D1$	$\phi D2$	$\phi d1$	x ϕ	β	E	H	H1	I	J	J1	J2	K	K1	L	M	$\phi O1$	V	v	X	X1	X2	Y
CAS-463-2T-5.5	782	875	459	383.5	200	M8	240	-	-	370	485	362	145	185	80	-	85	-	125	-	14	380	380	370	115	-	73.5
CAS-463-2T-7.5	782	875	517	441.5	200	M8	240	-	-	370	485	362	145	185	80	-	85	-	125	-	14	380	380	370	115	-	73.5
CAS-467-2T-7.5	833	945	530	442	224	M8	258	-	-	390	530	395	150	190	82.5	-	90	-	130	-	14	405	405	300	125	-	76
CAS-467-2T-10	833	945	530	442	224	M8	258	-	-	390	530	395	150	190	82.5	-	90	-	130	-	14	405	405	300	125	-	76
CAS-571-2T-10	873	995	536	445.5	250	M8	275	-	-	410	560	410	155	205	90	-	95	-	145	-	14	430	430	350	150	-	79.5
CAS-571-2T-15	873	995	671	580.5	250	M8	275	-	-	410	560	410	155	205	90	-	95	-	145	-	14	430	430	410	180	-	79.5
CAS-640-2T-2	639	728	446	350.5	250	M8	275	-	-	300	410	250	185	260	78	-	125	80	200	-	14	340	340	350	100	-	93.5
CAS-645-2T-3	699	788	461	358	250	M8	275	-	-	330	440	267.5	200	284	86	-	140	87.5	224	-	14	380	380	380	115	-	101
CAS-645-2T-4	699	788	491	388	250	M8	275	-	-	330	440	267.5	200	284	86	-	140	87.5	224	-	14	380	380	380	115	-	101
CAS-650-2T-5.5	782	875	534	421	250	M8	275	-	-	370	485	300	220	310	95	-	160	97.5	250	-	14	405	405	490	125	190	111
CAS-650-2T-7.5	782	875	572	459	250	M8	275	-	-	370	485	300	220	310	95	-	160	97.5	250	-	14	405	405	490	125	190	111
CAS-852-2T-7.5	833	945	603	470	380	M8	310	-	-	390	530	320	240	340	78	-	180	107.5	280	-	14	430	430	540	150	190	122
CAS-852-2T-10	833	945	603	470	380	M8	310	-	-	390	530	320	240	340	78	-	180	107.5	280	-	14	430	430	540	150	190	122
CAS-856-2T-15	833	945	708	575	355	M8	395	-	-	390	530	320	240	340	78	-	180	107.5	280	-	14	430	430	600	180	190	122
CAS-863-2T-15	873	995	728	585	355	M8	410	-	-	410	560	325	260	375	87.5	-	200	117.5	315	-	14	430	430	620	180	210	132
CAS-863-2T-20	873	995	728	585	355	M8	410	-	-	410	560	325	260	375	87.5	-	200	117.5	315	-	14	430	430	620	180	210	132
CAS-971-2T-25	1012	1170	759	598	400	M10	450	-	-	460	670	420	294	425	100	-	224	132	355	-	14	550	550	500	150	150	145
CAS-971-2T-30	1012	1170	881	720	400	M10	450	-	-	460	670	420	294	425	100	-	224	132	355	-	14	550	550	500	150	150	145

CAS/EW-790...980

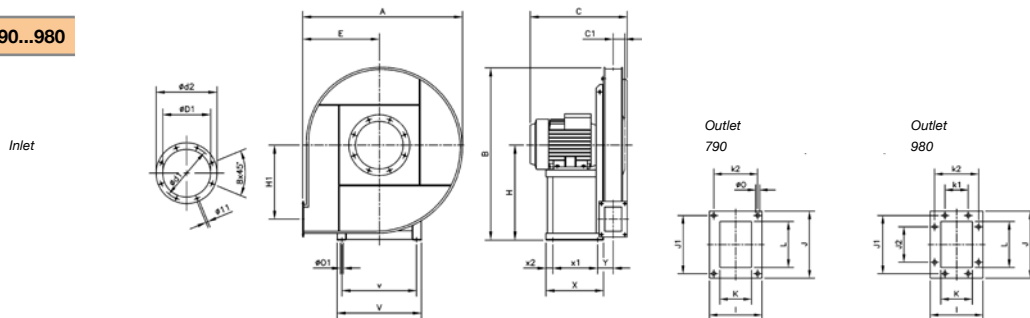

Model	A	B	C	C1	$\phi D1$	$\phi D2$	$\phi d1$	x ϕ	β	E	H	H1	I	J	J1	J2	K	K1	L	M	$\phi O1$	V	v	X	X1	X2	Y
CAS-790-2T-20	1100	1180	650	58	185	255	219	-	-	530	630	520	140	172	140	-	80	-	112	-	14	440	440	425	340	30	103
CAS-980-2T-30	1120	1250	725	90	255	325	292	-	-	530	710	530	210	270	241	112	140	112	200	-	14	440	440	425	340	35	145

CAS/EW-1250...1456

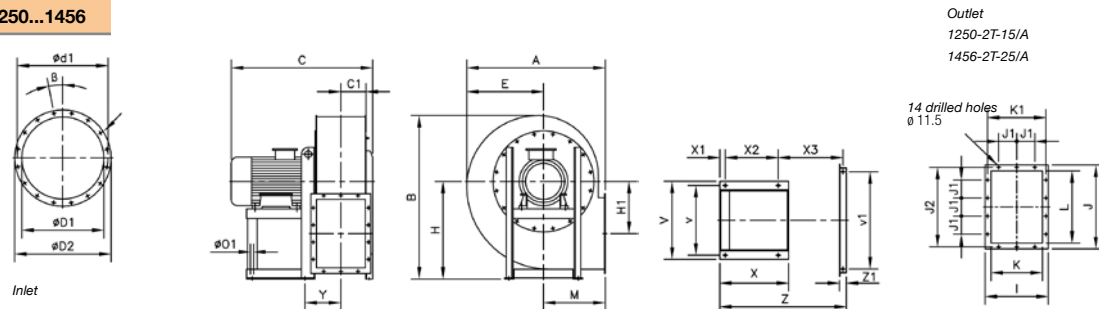

Model	A	B	C	C1	$\phi D1$	$\phi D2$	$\phi d1$	x ϕ	β	E	H	H1	I	J	J1	J2	K	K1	L	M	$\phi O1$	V	v	X	X1	X2	Y
CAS-1250-2T-15/A	865	1055	885	160	361	441	405	8x11.5	22°30'	510	630	365	360	480	125	448	280	332	400	355	14	440	440	425	30	340	202
CAS-1456-2T-25/A	970	1185	900	163	456	535	497	12x12	15°	555	710	410	395	530	125	497	315	366	450	400	14	440	440	425	30	340	219

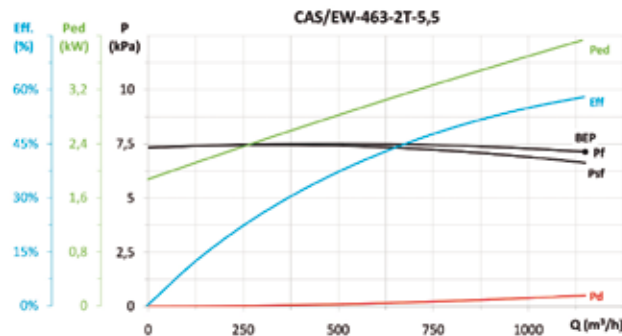
Erp. Characteristic curves and ErP data

MC	EC	SR	Cc	η_s (%)*	N	[kW]	[m³/h]	[Pa]	[rpm]	VSD
B	T	1,07	1,05	60,7%	65,0	3,931	1150	7135	2916	NECESSARY

* η_e (%) = Eff. (%) x Cc

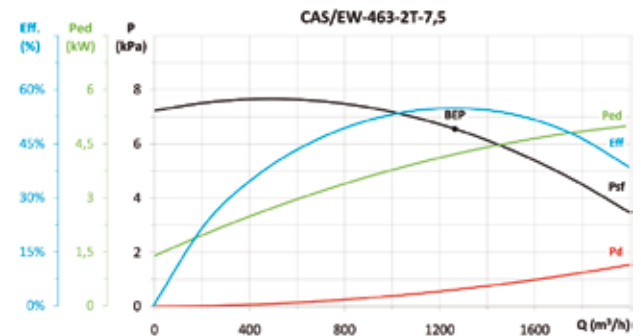

MC	EC	SR	Cc	η_s (%)*	N	[kW]	[m³/h]	[Pa]	[rpm]	VSD
A	S	1,07	1,04	57,3%	61,3	4,195	1264	6557,2	2954	NECESSARY

* η_e (%) = Eff. (%) x Cc

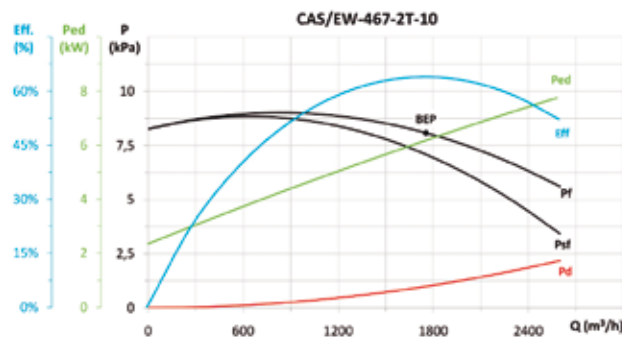

MC	EC	SR	Cc	η_s (%)*	N	[kW]	[m³/h]	[Pa]	[rpm]	VSD
B	T	1,08	1,04	66,5%	68,7	6,152	1754	8078,7	2954	NECESSARY

* η_e (%) = Eff. (%) x Cc

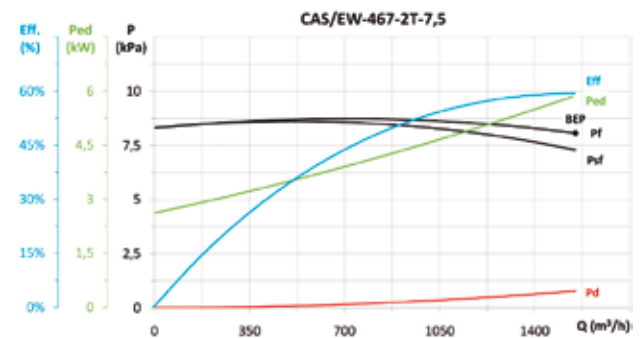

MC	EC	SR	Cc	η_s (%)*	N	[kW]	[m³/h]	[Pa]	[rpm]	VSD
B	T	1,08	1,04	61,8%	64,3	5,845	1550	8070,3	2936	NECESSARY

* η_e (%) = Eff. (%) x Cc

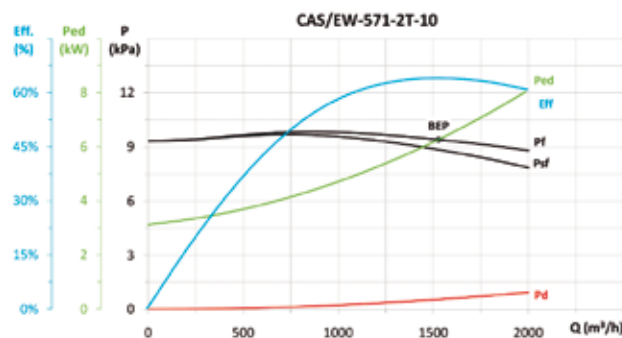

MC	EC	SR	Cc	η_s (%)*	N	[kW]	[m³/h]	[Pa]	[rpm]	VSD
B	T	1,09	1,04	66,6%	68,7	6,231	1528	9400,4	2953	NECESSARY

* η_e (%) = Eff. (%) x Cc

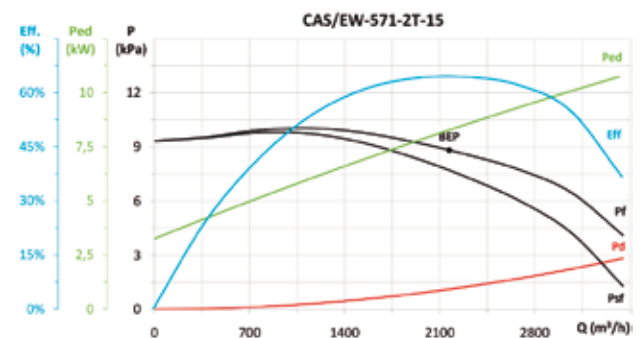

MC	EC	SR	Cc	η_s (%)*	N	[kW]	[m³/h]	[Pa]	[rpm]	VSD
B	T	1,09	1,04	67,1%	68,0	8,238	2170	8822,4	2951	NECESSARY

* η_e (%) = Eff. (%) x Cc

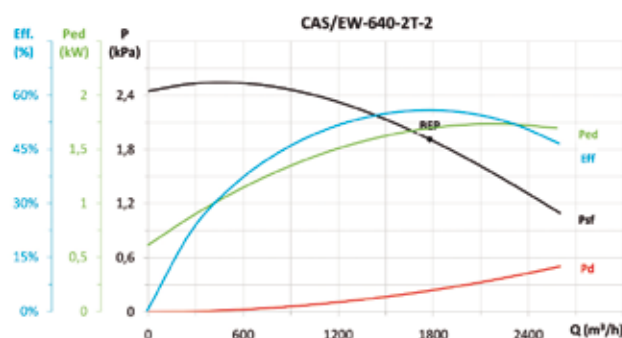

MC	EC	SR	Cc	η_s (%)*	N	[kW]	[m³/h]	[Pa]	[rpm]	VSD
A	S	1,02	1,07	59,8%	67,9	1,693	1778	1912,7	2886	NECESSARY

* η_e (%) = Eff. (%) x Cc

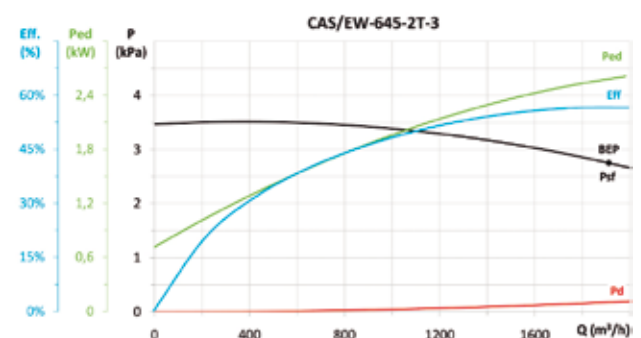

MC	EC	SR	Cc	η_s (%)*	N	[kW]	[m³/h]	[Pa]	[rpm]	VSD
A	S	1,03	1,06	60,1%	66,3	2,576	1912	2750,8	2913	NECESSARY

* η_e (%) = Eff. (%) x Cc



EFFICIENT WORK



Erp. Characteristic curves and ErP data

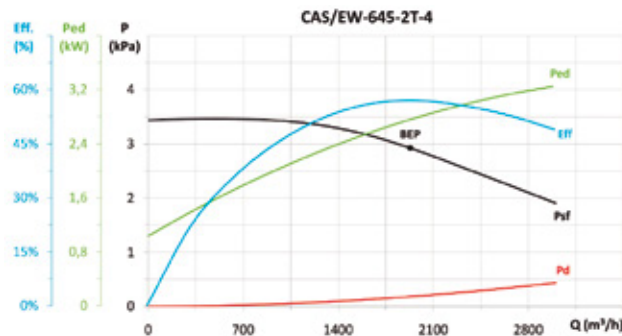

MC	EC	SR	Cc	η_e (%)*	N	[kW]	[m³/h]	[Pa]	[rpm]	VSD
A	S	1,03	1,06	60,3%	66,2	2,750	1930	2925,2	2932	NECESSARY

* η_e (%) = Eff. (%) x Cc

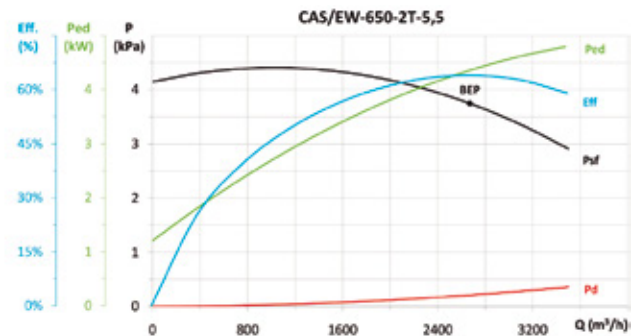

MC	EC	SR	Cc	η_e (%)*	N	[kW]	[m³/h]	[Pa]	[rpm]	VSD
A	S	1,04	1,04	66,8%	70,6	4,344	2671	3747,6	2908	NECESSARY

* η_e (%) = Eff. (%) x Cc

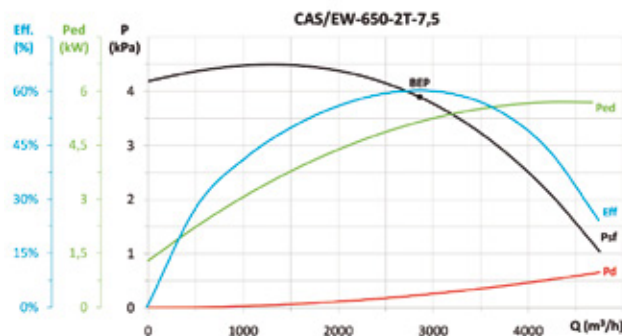

MC	EC	SR	Cc	η_e (%)*	N	[kW]	[m³/h]	[Pa]	[rpm]	VSD
A	S	1,04	1,04	62,6%	65,6	5,136	2858	3893,6	2944	NECESSARY

* η_e (%) = Eff. (%) x Cc

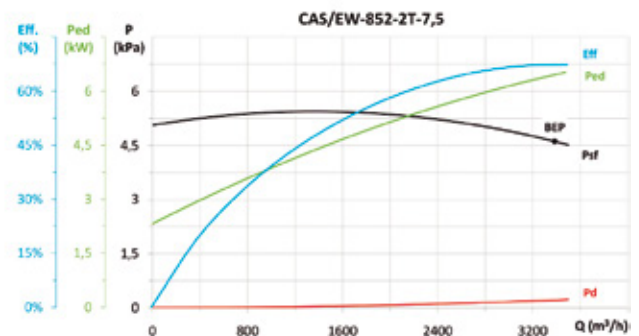

MC	EC	SR	Cc	η_e (%)*	N	[kW]	[m³/h]	[Pa]	[rpm]	VSD
A	S	1,05	1,04	70,1%	72,1	6,438	3385	4613,0	2930	NECESSARY

* η_e (%) = Eff. (%) x Cc

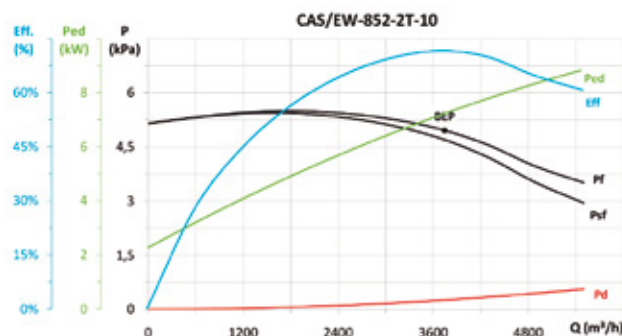

MC	EC	SR	Cc	η_e (%)*	N	[kW]	[m³/h]	[Pa]	[rpm]	VSD
B	T	1,05	1,04	74,5%	76,0	7,202	3744	4959,4	2946	NECESSARY

* η_e (%) = Eff. (%) x Cc

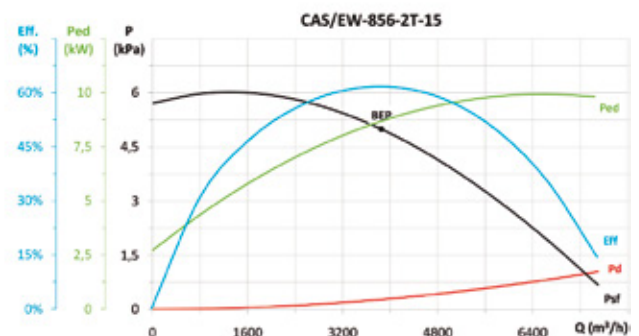

MC	EC	SR	Cc	η_e (%)*	N	[kW]	[m³/h]	[Pa]	[rpm]	VSD
A	S	1,05	1,04	64,2%	64,8	8,657	3851	4993,7	2949	NECESSARY

* η_e (%) = Eff. (%) x Cc

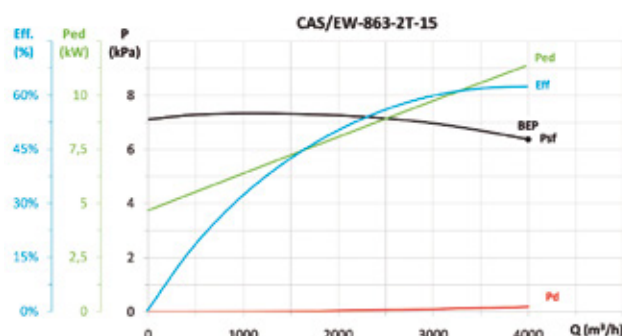

MC	EC	SR	Cc	η_e (%)*	N	[kW]	[m³/h]	[Pa]	[rpm]	VSD
A	S	1,06	1,04	64,9%	64,8	11,344	3998	6372,7	2933	NECESSARY

* η_e (%) = Eff. (%) x Cc

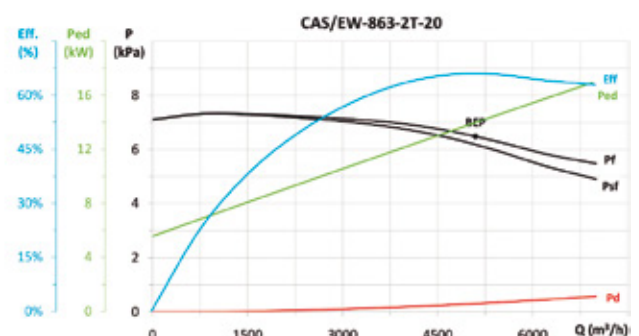

MC	EC	SR	Cc	η_e (%)*	N	[kW]	[m³/h]	[Pa]	[rpm]	VSD
B	T	1,06	1,04	68,7%	68,4	13,911	5097	6485,8	2955	NECESSARY

* η_e (%) = Eff. (%) x Cc



Erp. Characteristic curves and ErP data

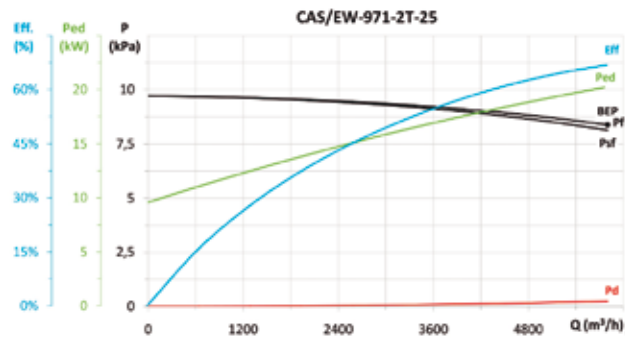

MC	EC	SR	Cc	η_e (%)*	N	[kW]	[m³/h]	[Pa]	[rpm]	VSD
B	T	1,08	1,04	69,5%	68,8	20,204	5800	8386,5	2946	NECESSARY

* η_e (%) = Eff. (%) x Cc

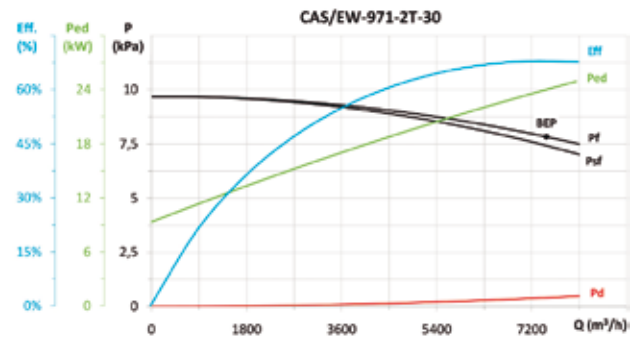

MC	EC	SR	Cc	η_e (%)*	N	[kW]	[m³/h]	[Pa]	[rpm]	VSD
B	T	1,08	1,04	70,7%	69,8	23,927	7478	7832,6	2956	NECESSARY

* η_e (%) = Eff. (%) x Cc

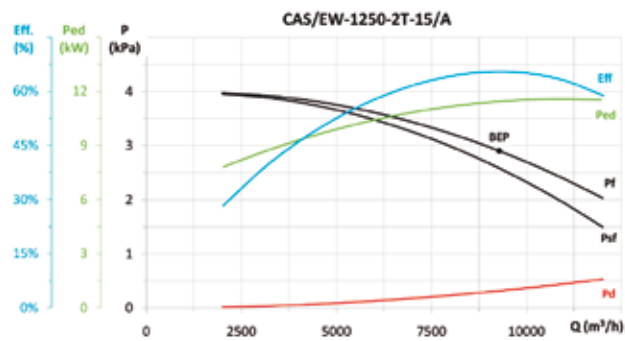

MC	EC	SR	Cc	η_e (%)*	N	[kW]	[m³/h]	[Pa]	[rpm]	VSD
B	T	1,03	1,04	68,1%	68,0	11,435	9279	2904,1	2932	NECESSARY

* η_e (%) = Eff. (%) x Cc

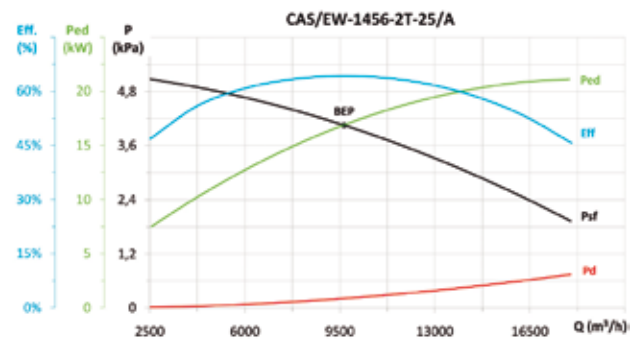

MC	EC	SR	Cc	η_e (%)*	N	[kW]	[m³/h]	[Pa]	[rpm]	VSD
A	S	1,04	1,04	66,8%	66,3	16,913	9659	4051,3	2955	NECESSARY

* η_e (%) = Eff. (%) x Cc

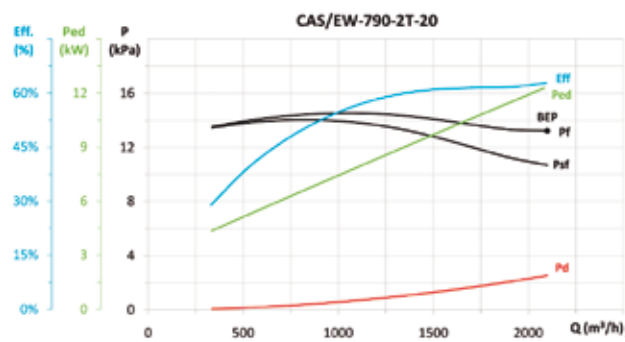

MC	EC	SR	Cc	η_e (%)*	N	[kW]	[m³/h]	[Pa]	[rpm]	VSD
B	T	1,13	1,04	65,3%	65,1	12,280	2100	13220	2959	NECESSARY

* η_e (%) = Eff. (%) x Cc

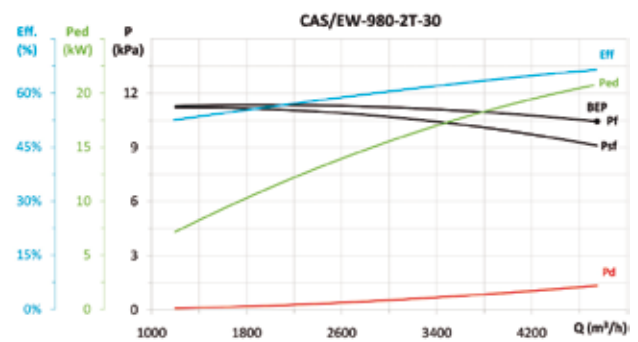

MC	EC	SR	Cc	η_e (%)*	N	[kW]	[m³/h]	[Pa]	[rpm]	VSD
B	T	1,10	1,04	69,1%	68,4	20,726	4750	10439	2962	NECESSARY

* η_e (%) = Eff. (%) x Cc

Accessories

See accessories section.



INT

VSD1/A-RFM
VSD3/A-RFT

AET

RPA

B

BIC

ACE

CJACUS

S

REG

CONTROL UNITS
AND SENSORS



EFFICIENT WORK



F-400



HIGHLY EFFICIENT
IE3-COMPLIANT
THREE-PHASE MOTORS

TCR/R/EW CJTCR/R/EW



VARIABLE SPEED DRIVE
VSD: Variable Speed Drive.
· VSD1/A-RFM
· VSD3/A-RFT
Supply on request

CONTROL
Supply optional accessory

SUPPLY
VSD1/A-RFM:
220-240 V 50/60 Hz
VSD3/A-RFT:
380-415 V 50/60 Hz

400°C/2h high-efficiency centrifugal fans and extraction units with backward-curved impeller fitted with IE3 asynchronous motor adjustable electronically.

TCR/R/EW: 400°C/2h robust high-efficiency centrifugal single-inlet fans to work outside fire danger zones fitted with impeller with backward-curved blades fitted with IE3 asynchronous motor adjustable electronically

CJTCR/R/EW: 400°C/2h robust high-efficiency single-inlet fans with soundproofed plate to work outside fire danger zones, fitted with IE3 asynchronous motor adjustable electronically

Fan:

- Steel sheet casing
- Impeller with backward-curved blades made from robust sheet steel and heat-resistant paint
- Approval according to Standard EN-12101-3-2002.

Motor and electronic variable speed:

- Motors with IE3 efficiency adjustable electronically.
- The variable speed drive VSD will be supplied as per order.
- Electronic variable speed drive (VSD) can be adjusted by external 0-10 V signal.
- It is advisable to install sinusoidal filters between the fan and the electronic variable speed drive (VSD) when they are far apart.
- Electronic variable speed drive (VSD), available with single-phase 220-240 V 50/60 Hz input (VSD1/B type) or three-phase 380-415 V 50/60 Hz (VSD3/B type).
- By default, the electronic variable speed drive (VSD) is delivered programmed for constant speed.
- Working temperature (VSD):
-25 °C +50 °C.

- Class F motors, with ball bearings, IP55 protection.
- Three-phase 230/400 V 50 Hz. (up to 5.5 CV.) and 400/690 V 50 Hz. (power over 5.5 CV.)
- Max. air temperature to transport: S1 Service -20°C+ 250°C for ongoing use, S2 Service S2 200°C/2h, 300°C/2h and 400°C/2h

Finish:

- Anticorrosive finish in polyester resin polymerised at 190°C, after alkaline degreasing with nanotechnology treatment and phosphate-free.
- CJTCR/R/EW: Anticorrosive galvanized sheet steel



Fan order code

TCR/R/EW — 1240 — 2T — IE3

TCR/R/EW: 400°C/2h High-efficiency centrifugal fans with backward-curved impeller, "Efficient work"
CJTCR/R/EW: 400°C/2h highly-efficient extraction units with backward-curved impeller, "Efficient work"

Impeller size

Number of poles:
2T=2850 r/min
4T=1400 r/min
6T=900 r/min

Three-phase motors IE3

Order code with variable speed drive (VSD) included

TCR/R/EW — 1240 — 2T — IE3 — VSD1 — D

TCR/R/EW: 400°C/2h high-efficiency centrifugal fans with backward-curved impeller, "Efficient work"
CJTCR/R/EW: High-efficiency 400°C/2h extraction units with backward-curved impeller, "Efficient work"

Impeller size

Number of poles:
2T=2850 r/min
4T=1400 r/min
6T=900 r/min

Three-phase motor IE3

VSD1: Fitted with VSD1/A-RFM, electronic variable speed, single phase power supply 220-240 V 50/60 Hz.
VSD3: Fitted with VSD3/A-RFT, electronic variable speed, three-phase power supply 380-415 V 50/60 Hz.

D: Standard version, VSD supplied programmed for constant speed.
P: Supplied with VSD programmed for pressure control and Si-Presión pressure transmitter
K: Supplied with VSD programmed for pressure control and built into a BOXPRES KIT/B box.
Only available for fans with motor power less than or equal to 2.2 kW.

Technical characteristics

Model	Speed min/max (r/min)	Single-phase VSD 230 V 50/60 Hz		Three-phase VSD 400 V 50/60 Hz		Maximum current Motor 50 Hz		Installed power (kW)	Maximum airflow min/max (m ³ /h)	Sound pressure level Lp dB(A)		Weight approx. (Kg)		
		Maximum current input (A)	Model VSD	Maximum current input (A)	Model VSD	230V	400V 690V			TCR/R/EW min/max	CJTCR/R/EW min/max	TCR/R/EW min/max	CJTCR/R/EW min/max	
TCR/R/EW CJTCR/R/EW	1240-2T 1160/2900	-	-	9.44	VSD3/A-RFT-5.5	13	7.5	-	4.00	4440 / 11100	66 / 86	61 / 81	93	147
TCR/R/EW CJTCR/R/EW	1240-4T 570/1420	8.32	VSD1/A-RFM-1	2.31	VSD3/A-RFT-1	2.82	1.62	-	0.75	2330 / 5800	51 / 71	46 / 66	71	125
TCR/R/EW CJTCR/R/EW	1445-2T 1175/2935	-	-	17.45	VSD3/A-RFT-10	-	13.9	8.06	7.50	6605 / 16500	67 / 87	62 / 82	126	210
TCR/R/EW CJTCR/R/EW	1445-4T 580/1455	11.87	VSD1/A-RFM-2	3.30	VSD3/A-RFT-2	4.07	2.34	-	1.10	3200 / 8030	52 / 72	47 / 67	93	177
TCR/R/EW CJTCR/R/EW	1650-4T 575/1440	15.78	VSD1/A-RFM-2	4.38	VSD3/A-RFT-2	5.41	3.11	-	1.50	4195 / 10500	54 / 74	48 / 68	114	189
TCR/R/EW CJTCR/R/EW	1650-6T 375/940	8.69	VSD1/A-RFM-1	2.41	VSD3/A-RFT-1	3.36	1.93	-	0.75	2955 / 7410	44 / 64	39 / 59	111	186
TCR/R/EW CJTCR/R/EW	1856-4T 575/1440	-	-	7.20	VSD3/A-RFT-5.5	10.7	6.15	-	3.00	6050 / 15150	59 / 79	54 / 74	152	273
TCR/R/EW CJTCR/R/EW	1856-6T 380/945	12.43	VSD1/A-RFM-2	3.45	VSD3/A-RFT-2	4.68	2.69	-	1.10	4040 / 10050	50 / 70	45 / 65	145	266
TCR/R/EW CJTCR/R/EW	2063-4T 585/1465	-	-	12.81	VSD3/A-RFT-7.5	-	10.3	5.97	5.50	9765 / 24450	60 / 80	55 / 75	225	380
TCR/R/EW CJTCR/R/EW	2063-6T 380/950	16.64	VSD1/A-RFM-2	4.62	VSD3/A-RFT-2	6.43	3.7	-	1.50	6440 / 16100	51 / 71	46 / 66	209	364
TCR/R/EW CJTCR/R/EW	2271-4T 590/1470	-	-	25.10	VSD3/A-RFT-15	-	21.4	12.4	11.00	13890 / 34610	65 / 85	59 / 79	315	508
TCR/R/EW CJTCR/R/EW	2271-6T 390/970	-	-	7.39	VSD3/A-RFT-5.5	12	6.91	-	3.00	9145 / 22750	56 / 76	51 / 71	280	473

Dimensions in mm

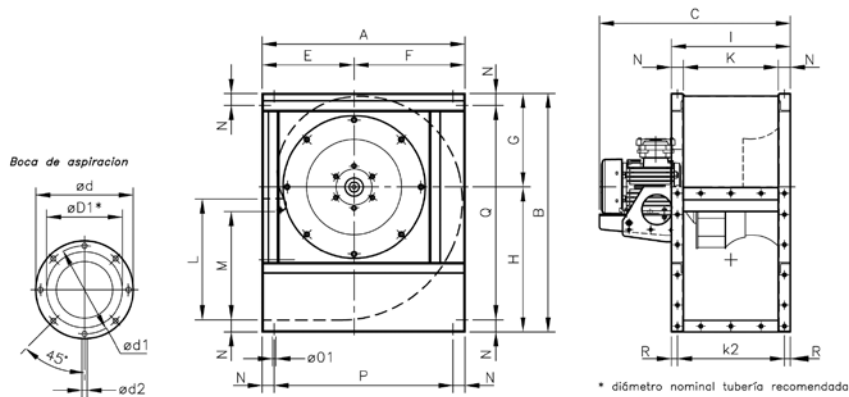

Model	A	B	C	ØD1*	Ød	Ød1	Ød2	E	F	G	H	I	M	N	Ø01	P	Q	R
TCR/R/EW 1240-2T	673	790	734	400	472	444	M.8	305	368	310	480	395	358.5	40	11	593	710	20
TCR/R/EW 1240-4T	673	790	634	400	472	444	M.8	305	368	310	480	395	358.5	40	11	593	710	20
TCR/R/EW 1445-2T	765	880	815	450	522	494	M.8	350	415	339	541	445	407	45	11	675	790	20
TCR/R/EW 1445-4T	765	880	727	450	522	494	M.8	350	415	339	541	445	407	45	11	675	790	20
TCR/R/EW 1650-4T	832	970	770.5	500	582	555	M.10	375	457	378	592	490	445	45	13	742	880	20
TCR/R/EW 1650-6T	832	970	770.5	500	582	555	M.10	375	457	378	592	490	445	45	13	742	880	20
TCR/R/EW 1856-4T	925	1084	857.5	560	645	615	M.10	415	510	424	660	550	493	50	13	825	984	25
TCR/R/EW 1856-6T	925	1084	828	560	645	615	M.10	415	510	424	660	550	493	50	13	825	984	25
TCR/R/EW 2063-4T	1037	1218	955	630	720	688	M.10	465	572	477	741	620	530	60	13	917	1098	30
TCR/R/EW 2063-6T	1037	1218	932	630	720	688	M.10	465	572	477	741	620	530	60	13	917	1098	30
TCR/R/EW 2271-4T	1173	1375	1149	710	800	768	M.12	525	648	538	837	690	603.5	65	13	1043	1245	32.5
TCR/R/EW 2271-6T	1173	1375	1112	710	800	768	M.12	525	648	538	837	690	603.5	65	13	1043	1245	32.5



EFFICIENT WORK



Dimensions in mm

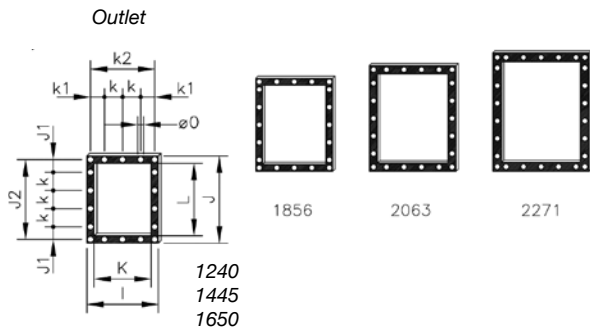

Model	I	J	J1	J2	K	k	k1	k2	L	Ø0
TCR/R/EW-1240	395	480	70	440	315	100	77.5	355	400	11
TCR/R/EW-1445	445	540	99	498	355	100	102.5	405	450	11
TCR/R/EW-1650	490	590	87.5	550	400	125	100	450	500	13
TCR/R/EW-1856	550	660	55	610	450	125	125	500	560	13
TCR/R/EW-2063	620	750	95	690	500	125	92.5	560	630	13
TCR/R/EW-2271	690	840	75	775	560	125	62.5	625	710	13

Standard supply: LG-270

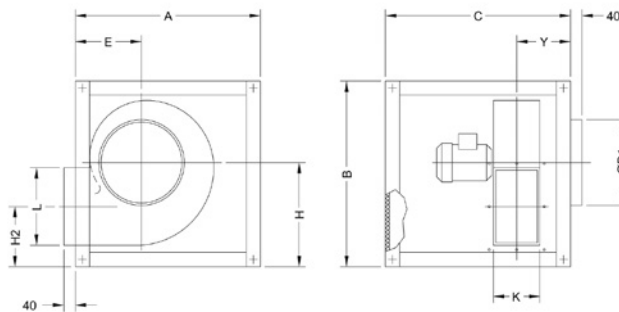

Model	A	B	C	ØD1	E	H	H2	K	L	Y
CJTCR/R/EW-1240	970	970	970	400	312	549	308	315	400	307.5
CJTCR/R/EW-1445	1070	1070	1070	450	357	610	339	355	450	333.5
CJTCR/R/EW-1650	1160	1160	1160	500	382	660	365	400	500	355
CJTCR/R/EW-1856	1260	1260	1050	560	422	727	399	450	560	360
CJTCR/R/EW-2063	1400	1400	1200	630	472	810	444	500	630	395
CJTCR/R/EW-2271	1555	1555	1355	710	532	906	560	560	715	430

Supplied on request: LG-0

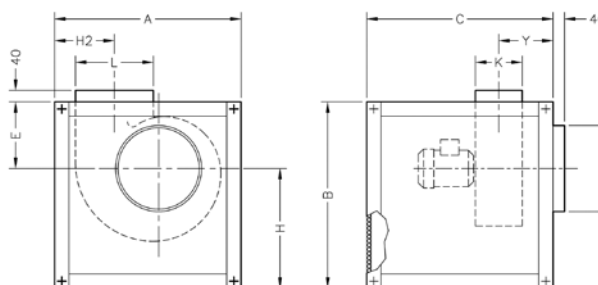

Model	A	B	C	ØD1	E	H	H2	K	L	Y
CJTCR/R/EW-1240	970	970	970	400	533	437	322	315	400	307.5
CJTCR/R/EW-1445	1070	1070	1070	450	586	484	367	355	450	333.5
CJTCR/R/EW-1650	1160	1160	1160	500	634.5	525.5	391.5	400	500	355
CJTCR/R/EW-1856	1260	1260	1050	560	681.5	578.5	442.5	450	560	360
CJTCR/R/EW-2063	1400	1400	1200	630	759	641	482	500	630	395
CJTCR/R/EW-2271	1555	1555	1355	710	838	717	518.5	560	715	430



Dimensions in mm

Supplied on request: LG-90

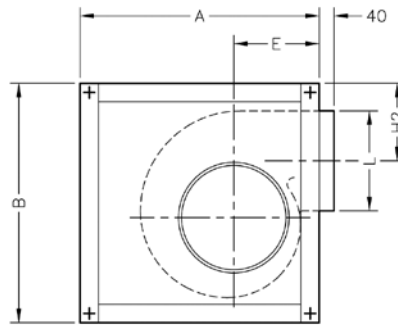
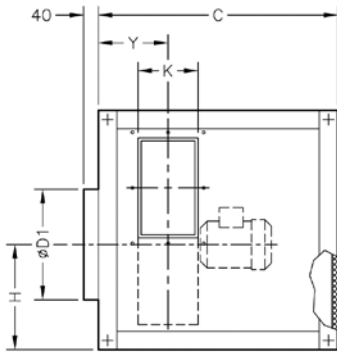

Detail of drills outlet

1240
1445
1650
2271

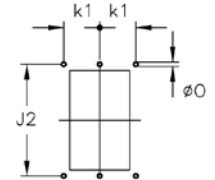

1856
2063

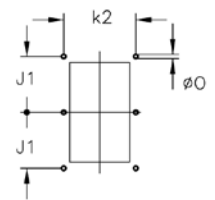

Model	A	B	C	ØD1	E	H	H2	K	L	Y
CJTCR/R/EW-1240	970	970	970	400	312	379	350	315	400	307.5
CJTCR/R/EW-1445	1070	1070	1070	450	357	408	391	355	450	333.5
CJTCR/R/EW-1650	1160	1160	1160	500	382	447	419	400	500	355
CJTCR/R/EW-1856	1260	1260	1050	560	422	495	438	450	560	360
CJTCR/R/EW-2063	1400	1400	1200	630	472	546	488	500	630	395
CJTCR/R/EW-2271	1555	1555	1355	710	532	607	532	560	715	430

Model	k1	k2	J1	J2	Ø0
CJTCR/R/EW-1240	177.5	-	-	440	11
CJTCR/R/EW-1445	202.5	-	-	498	11
CJTCR/R/EW-1650	225	-	-	550	13
CJTCR/R/EW-1856	-	500	305	-	13
CJTCR/R/EW-2063	-	560	345	-	13
CJTCR/R/EW-2271	312.5	-	-	775	13



Erp. Characteristic curves and ErP data

See CMR/EW curves

Positions

LG 270 standard supply



Accessories

See accessories section.

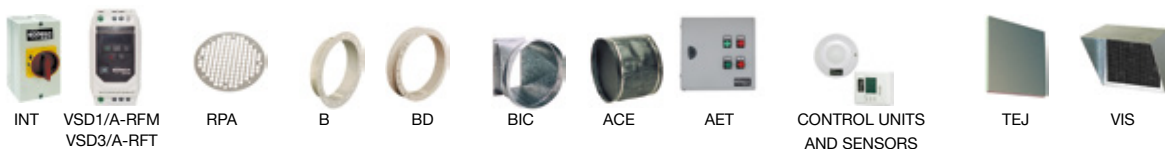



EFFICIENT WORK



INDUSTRIAL BRUSHLESS MOTOR E.C.

CJLINE/EW

400°C/2h extraction units with linear inlet and outlet fitted with industrial Brushless motor E.C.



400°C/2h in-line extraction units to work outside the fire danger zone fitted with industrial Brushless motor E.C.

Fan:

- Galvanized sheet steel structure.
- Impeller with backward-curved blades made from sheet steel
- Approval according to Standard EN-12101-3-2002.
- Linear air circulation



VARIABLE SPEED DRIVE
VSD: Variable Speed Drive.
• VSD1/B
• VSD3/B

Supply included with fan

CONTROL
Supply optional accessory

SUPPLY
VSD1/B:
220-240 V 50/60 Hz
VSD3/B:
380-415 V 50/60 Hz

Motor and electronic variable speed:

- High-efficiency Industrial Brushless Motors E.C., fitted with electronic variable speed (VSD), adjustable via external control input 0-10V.
- It is advisable to install an electronic variable speed drive (VSD) outside the working area.
- The external signal can be supplied through a manual or automatic control with 0-10 V output.
- Electronic variable speed drive (VSD), available with single-phase 220-240 V 50/60 Hz input (VSD1/B type) or

three-phase 380-415 V 50/60 Hz (VSD3/B type).

- By default, the electronic variable speed drive (VSD) is delivered programmed for constant speed.
- Working fan temperature: -25 °C +60 °C.
- Working temperature (VSD): -25 °C +50 °C.

Finish:

- Anticorrosive galvanized sheet steel

Order code with variable speed drive (VSD) included

CJLINE/EW — 1131 — 4 — B — T — D

CJLINE/EW: 400°C/2h high-efficiency belt-driven extraction units, "Efficient work", with linear inlet and outlet

Impeller size

Number of poles:
4=1410 r/min
6=960 r/min

Industrial Brushless Motors E.C.

M: Fitted with VSD1/B, electronic variable speed, single phase power supply 220-240 V 50/60 Hz.

T: Fitted with VSD3/B, electronic variable speed, three-phase power supply 380-415 V 50/60 Hz.

D: Standard version, VSD supplied programmed for constant speed.
P: Supplied with VSD programmed for pressure control and Si-Presión pressure transmitter
K: Supplied with VSD programmed for pressure control and built into a BOXPRES KIT/B box.

Technical characteristics

Model	Speed min/max (r/min)	Single-phase VSD 230 V 50/60 Hz		Three-phase VSD 400 V 50/60 Hz		Maximum electrical power (W)	Maximum airflow min/max (m³/h)	Sound pressure level min/max dB(A)	Weight approx. (Kg)
		Maximum current input (A)	Model VSD	Maximum current input (A)	Model VSD				
CJLINE/EW-1131-4	300 / 1410	1.44	VSD1/B-0.37	0.42	VSD3/B-0.75	175	410 / 1920	17 / 51	39
CJLINE/EW-1235-4	300 / 1410	2.79	VSD1/B-0.37	0.82	VSD3/B-0.75	340	625 / 2945	22 / 56	54
CJLINE/EW-1235-6	300 / 960	1.17	VSD1/B-0.37	0.34	VSD3/B-0.75	140	595 / 1900	25 / 50	55
CJLINE/EW-1640-4	300 / 1410	5.82	VSD1/B-0.75	1.37	VSD3/B-1.5	660	1000 / 4700	27 / 61	65
CJLINE/EW-1640-6	300 / 960	2.13	VSD1/B-0.37	0.62	VSD3/B-0.75	255	920 / 2950	29 / 54	66
CJLINE/EW/H-1650-4	300 / 1410	15.89	VSD1/B-1.5	3.74	VSD3/B-1.5	1825	2085 / 9800	40 / 74	99
CJLINE/EW-1845-4	300 / 1410	7.94	VSD1/B-0.75	1.87	VSD3/B-1.5	905	1415 / 6650	31 / 65	83
CJLINE/EW-1845-6	300 / 960	4.28	VSD1/B-0.75	1.00	VSD3/B-1.5	480	1340 / 4280	32 / 57	81
CJLINE/EW-1856-6	300 / 960	8.32	VSD1/B-1.5	1.96	VSD3/B-1.5	955	2420 / 7750	34 / 59	142
CJLINE/EW-2063-6	300 / 960	11.51	VSD1/B-1.5	2.71	VSD3/B-1.5	1325	3470 / 11100	36 / 61	185

Acoustic features

The specified values are determined according to free field measurements of pressure and sound levels in dB(A) at an equivalent distance of twice the fan's span plus the turbine's diameter, with a minimum of 1.5 m.

Sound power Lw(A) spectrum in dB(A) via frequency band in Hz.

Model	63	125	250	500	1000	2000	4000	8000	Model	63	125	250	500	1000	2000	4000	8000
CJLINE/EW-1131-4	42	51	57	56	60	60	52	46	CJLINE/EW/H-1650-4	64	74	82	84	83	85	76	66
CJLINE/EW-1235-4	49	58	64	63	67	66	59	53	CJLINE/EW-1845-4	60	66	71	72	75	77	69	63
CJLINE/EW-1235-6	43	52	58	57	61	60	53	47	CJLINE/EW-1845-6	52	58	63	64	67	69	61	55
CJLINE/EW-1640-4	56	62	67	68	71	73	65	59	CJLINE/EW-1856-6	58	64	69	70	73	72	65	60
CJLINE/EW-1640-6	49	55	60	61	64	66	58	52	CJLINE/EW-2063-6	60	66	72	72	76	76	68	61

Dimensions in mm

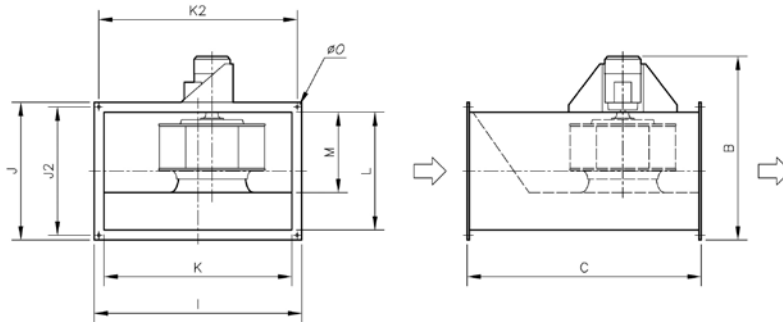

Model	B	C	I	J	J2	K	k2	L	M	ØO
CJLINE/EW-1131	760	710	620	510	483	560	593	450	175	10
CJLINE/EW-1235	830	800	680	560	533	620	653	500	213	10
CJLINE/EW-1640	890	900	770	620	593	710	743	560	262	10
CJLINE/EW-1650/H	942	1000	860	690	663	800	833	630	290	10
CJLINE/EW-1845	1010	1000	860	690	663	800	833	630	290	10
CJLINE/EW-1856	1280	1250	1060	860	833	1000	1033	800	378	10
CJLINE/EW-2063	1390	1400	1205	980	938	1125	1163	900	378	12



Erp. Characteristic curves and ErP data

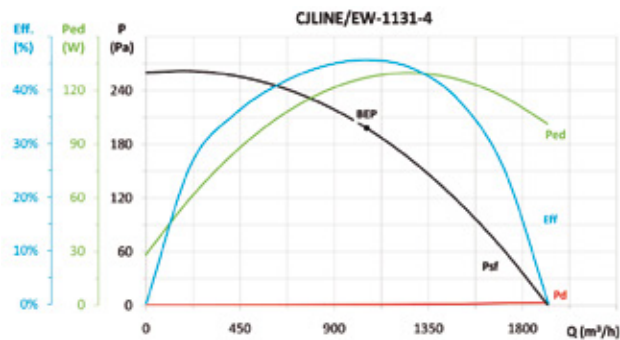

MC	EC	SR	Cc	η_e (%)*	N	[kW]	[m ³ /h]	[Pa]	[rpm]	VSD
C	S	1,00	1,15	52,5%	72,4	0,127	1055	198	1410	INCLUDED

* η_e (%) = Eff. (%) x Cc

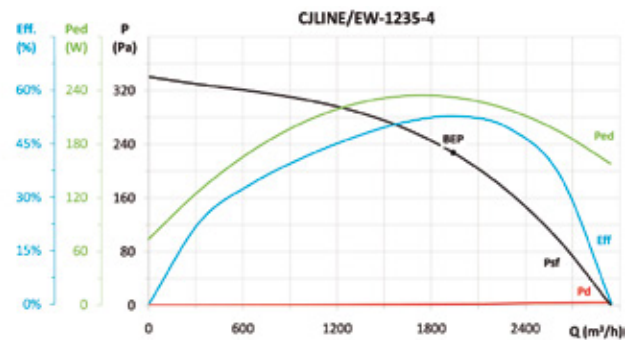

MC	EC	SR	Cc	η_e (%)*	N	[kW]	[m ³ /h]	[Pa]	[rpm]	VSD
C	S	1,00	1,13	59,6%	76,8	0,232	1940	227	1410	INCLUDED

* η_e (%) = Eff. (%) x Cc

Accessories

See accessories section.





EFFICIENT WORK



Erp. Characteristic curves and ErP data

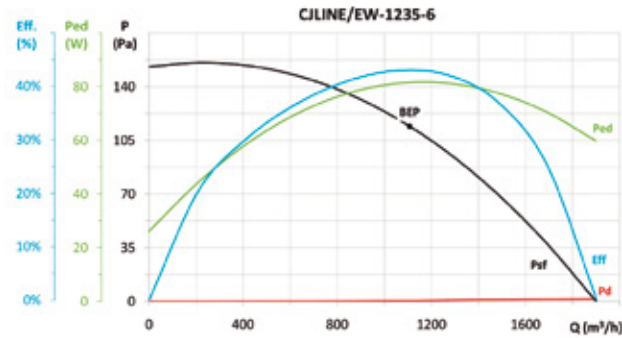

MC	EC	SR	Cc	η_b (%)*	N	[kW]	[m³/h]	[Pa]	[rpm]	VSD
C	S	-	-	-	-	0,082	1108	114	960	INCLUDED

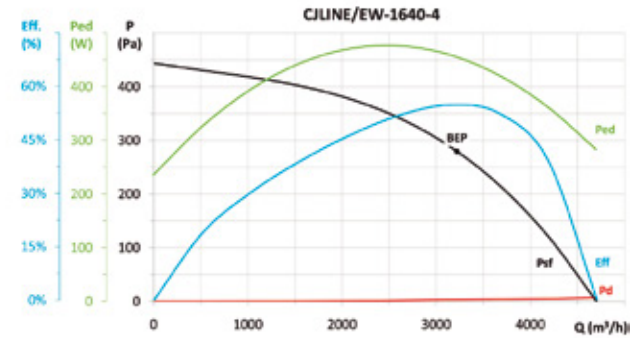

MC	EC	SR	Cc	η_b (%)*	N	[kW]	[m³/h]	[Pa]	[rpm]	VSD
C	S	1,00	1,11	61,1%	75,1	0,455	3221	280	1410	INCLUDED

* η_e (%) = EFF. (%) x Cc

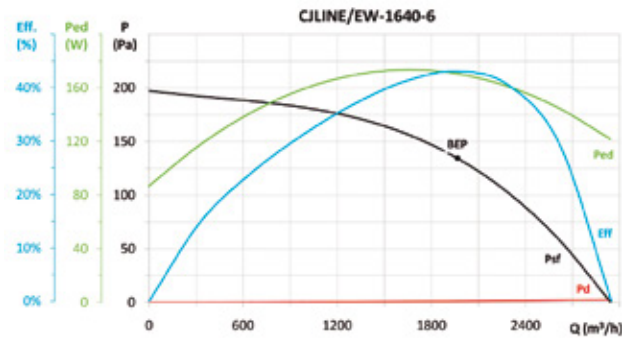

MC	EC	SR	Cc	η_b (%)*	N	[kW]	[m³/h]	[Pa]	[rpm]	VSD
C	S	1,00	1,14	49,1%	67,7	0,170	1965	134	960	INCLUDED

* η_e (%) = EFF. (%) x Cc

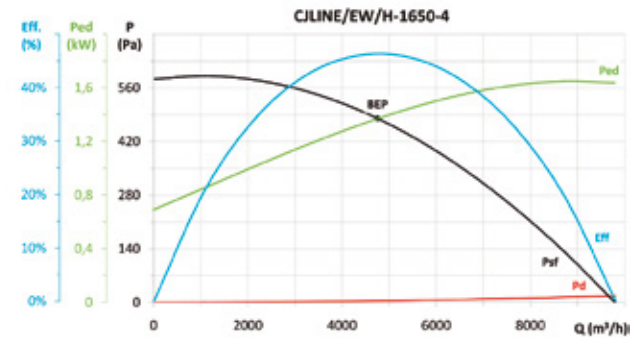

MC	EC	SR	Cc	η_b (%)*	N	[kW]	[m³/h]	[Pa]	[rpm]	VSD
C	S	1,00	1,08	50,0%	59,0	1,368	4752	480	1410	INCLUDED

* η_e (%) = EFF. (%) x Cc

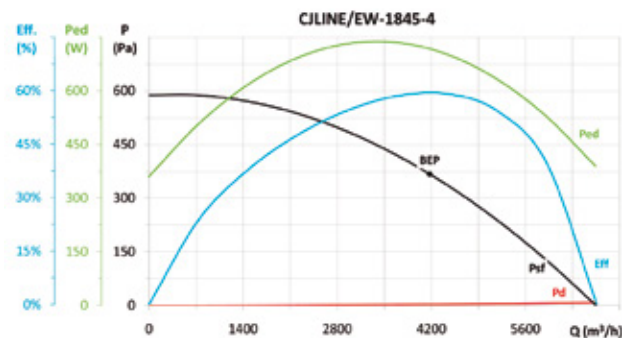

MC	EC	SR	Cc	η_b (%)*	N	[kW]	[m³/h]	[Pa]	[rpm]	VSD
C	S	1,00	1,10	65,2%	77,2	0,718	4174	368	1410	INCLUDED

* η_e (%) = EFF. (%) x Cc

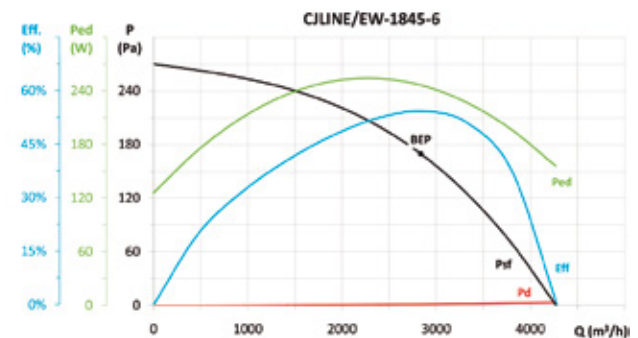

MC	EC	SR	Cc	η_b (%)*	N	[kW]	[m³/h]	[Pa]	[rpm]	VSD
C	S	1,00	1,13	61,3%	78,1	0,247	2836	170	960	INCLUDED

* η_e (%) = EFF. (%) x Cc

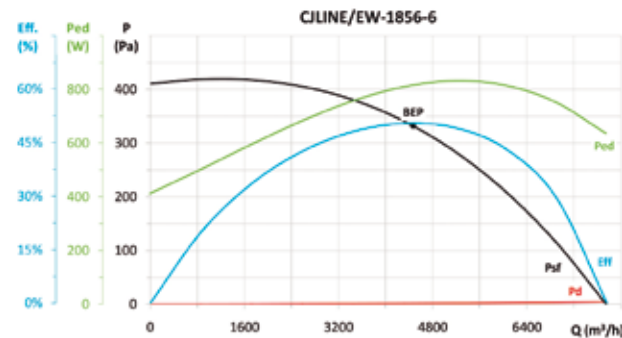

MC	EC	SR	Cc	η_b (%)*	N	[kW]	[m³/h]	[Pa]	[rpm]	VSD
C	S	1,00	1,09	55,2%	66,7	0,816	4468	332	960	INCLUDED

* η_e (%) = EFF. (%) x Cc

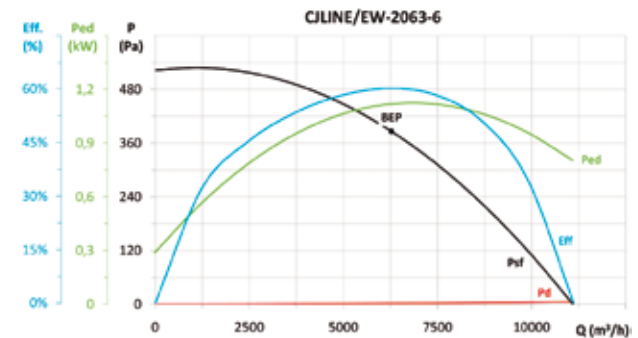

MC	EC	SR	Cc	η_b (%)*	N	[kW]	[m³/h]	[Pa]	[rpm]	VSD
C	S	1,00	1,08	65,3%	75,3	1,118	6275	386	960	INCLUDED

* η_e (%) = EFF. (%) x Cc

CJEC/EW

INDUSTRIAL BRUSHLESS MOTOR E.C.

Extraction units with large hatch to facilitate maintenance, fitted with industrial Brushless motor E.C.



VARIABLE SPEED DRIVE
VSD: Variable Speed Drive
Drive: VSD1/B
VSD3/B

Supply included with fan

CONTROL
Supply optional accessory

SUPPLY
VSD1/B:
220-240 V 50/60 Hz
VSD3/B:
380-415 V 50/60 Hz

Fan:

- Galvanized sheet steel structure.
- Impeller with backward-curved blades made from galvanised sheet steel
- Approval according to Standard EN-12101-3-2002.
- Outlet mounting on any side of the box possible, during installation

Motor and electronic variable speed:

- High-efficiency Industrial Brushless Motors E.C., fitted with electronic variable speed (VSD), adjustable via external control input 0-10V.
- It is advisable to install an electronic variable speed drive (VSD) outside the working area.
- The external signal can be supplied through a manual or automatic control with 0-10 V output.
- Electronic variable speed drive (VSD), available with single-phase 220-240 V 50/60 Hz input (VSD1/B type) or three-phase 380-415 V 50/60 Hz (VSD3/B type).

- By default, the electronic variable speed drive (VSD) is delivered programmed for constant speed.
- Working fan temperature: -25 °C +60 °C.
- Working temperature (VSD): -25 °C +50 °C.

Finish:

- Anticorrosive galvanized sheet steel

Order code with variable speed drive (VSD) included

CJEC/EW — 280 — 4 — B — T — D

CJEC/EW: 400°C/2h high-efficiency belt-driven extraction units, "Efficient work", with horizontal outlet air

Impeller size

Number of poles:
4=1410 r/min
6=960 r/min

Industrial Brushless Motors E.C.

M: Fitted with VSD1/B, electronic variable speed, single phase power supply 220-240 V 50/60 Hz.
T: Fitted with VSD3/B, electronic variable speed, three-phase power supply 380-415 V 50/60 Hz.

D: Standard version, VSD supplied programmed for constant speed.
P: Supplied with VSD programmed for pressure control and Si-Presión pressure transmitter
K: Supplied with VSD programmed for pressure control and built into a BOXPRES KIT/B box.

Technical characteristics

Model	Speed min/max (r/min)	Single-phase VSD 230 V 50/60 Hz		Three-phase VSD 400 V 50/60 Hz		Maximum electrical power (W)	Maximum airflow min/max (m³/h)	Sound pressure level Lp dB(A)		Weight approx. (Kg)
		Maximum current input (A)	Model VSD	Maximum current input (A)	Model VSD			Inlet min/max	Outlet min/max	
CJEC/EW-280-4	300 / 1410	1.14	VSD1/B-0.37	0.34	VSD3/B-0.75	140	290 / 1370	21 / 55	26 / 60	61
CJEC/EW-315-4	300 / 1410	1.44	VSD1/B-0.37	0.42	VSD3/B-0.75	175	350 / 1650	25 / 59	29 / 63	63
CJEC/EW-355-4	300 / 1410	2.79	VSD1/B-0.37	0.82	VSD3/B-0.75	340	640 / 3000	27 / 61	32 / 66	75
CJEC/EW-400-4	300 / 1410	5.82	VSD1/B-0.75	1.37	VSD3/B-1.5	660	905 / 4250	31 / 65	35 / 69	79
CJEC/EW-450-4	300 / 1410	7.94	VSD1/B-0.75	1.87	VSD3/B-1.5	905	1170 / 5500	34 / 68	38 / 72	89
CJEC/EW-500-4	300 / 1410	15.89	VSD1/B-1.5	3.74	VSD3/B-1.5	1825	1895 / 8900	36 / 70	41 / 75	110
CJEC/EW-560-6	300 / 960	11.51	VSD1/B-1.5	2.71	VSD3/B-1.5	1325	2970 / 9500	52 / 77	57 / 82	129

Acoustic features

The specified values are determined according to free field measurements of pressure and sound levels in dB(A) at an equivalent distance of twice the fan's span plus the turbine's diameter, with a minimum of 1.5 m.

Sound power Lw(A) spectrum in dB(A) via frequency band in Hz.

Values taken at inlet with maximum airflow.

Model	Values taken at inlet with maximum airflow.								Values taken at outlet with maximum airflow.							
	63	125	250	500	1000	2000	4000	8000	63	125	250	500	1000	2000	4000	8000
280-4	42	47	62	59	60	58	53	45	42	45	65	66	65	65	58	49
315-4	53	62	64	64	64	62	54	42	45	59	67	69	68	68	60	53
355-4	52	62	68	63	64	66	62	53	48	67	68	71	72	71	64	55
400-4	60	69	72	65	68	69	65	56	52	70	73	73	75	74	70	59
450-4	56	65	71	76	72	71	65	57	56	69	75	77	79	76	71	61
500-4	57	62	73	76	76	75	69	60	58	67	78	79	83	80	74	63
560-6	69	78	80	81	82	82	79	57	65	79	85	86	90	86	81	72



EFFICIENT WORK



Dimensions in mm

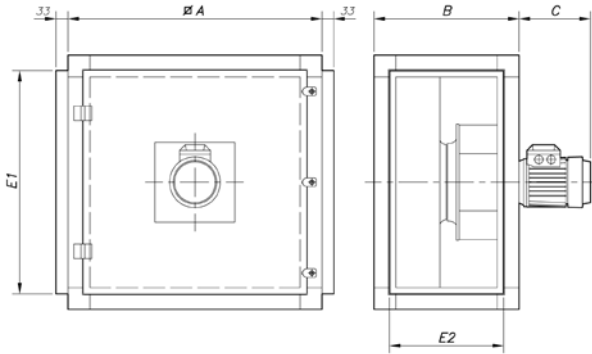

Model	ØA	B	C	E1	E2
CJEC/EW-280	700	400	200	618	318
CJEC/EW-315	700	400	200	618	318
CJEC/EW-355	800	505	200	718	423
CJEC/EW-400	800	505	225	718	423
CJEC/EW-450	900	550	225	818	468
CJEC/EW-500	900	550	260	818	468
CJEC/EW-560	1000	700	290	918	618



Erp. Characteristic curves and ErP data

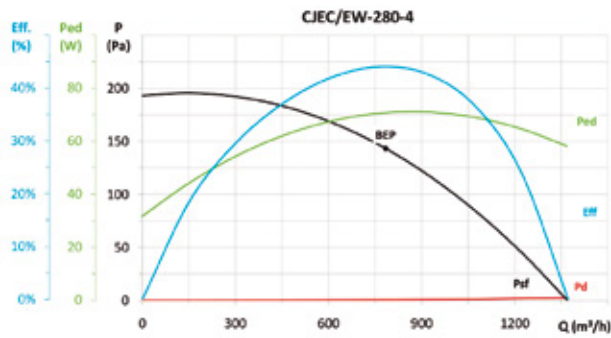

MC	EC	SR	Cc	η_e (%)*	N	[kW]	[m³/h]	[Pa]	[rpm]	VSD
C	S	-	-	-	-	0,071	784	143	1410	INCLUDED

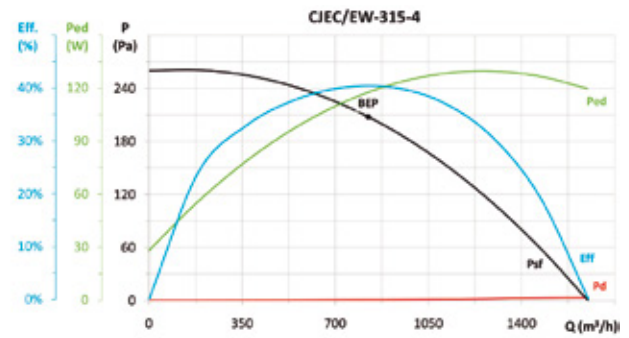

MC	EC	SR	Cc	η_e (%)*	N	[kW]	[m³/h]	[Pa]	[rpm]	VSD
C	S	-	-	-	-	0,118	824	208	1410	INCLUDED

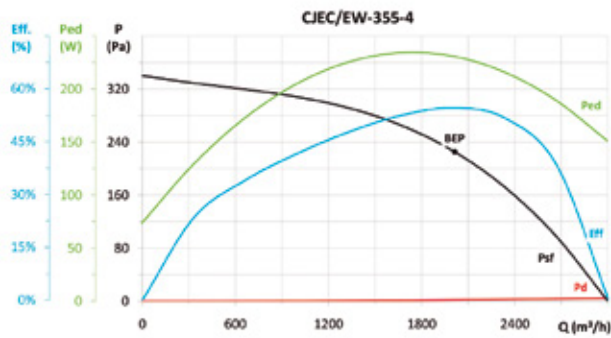

MC	EC	SR	Cc	η_e (%)*	N	[kW]	[m³/h]	[Pa]	[rpm]	VSD
C	S	1,00	1,13	61,8%	79,0	0,231	2012	225	1410	INCLUDED

* η_e (%) = Eff. (%) x Cc

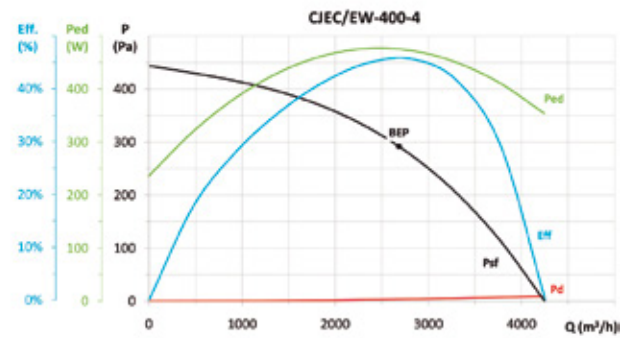

MC	EC	SR	Cc	η_e (%)*	N	[kW]	[m³/h]	[Pa]	[rpm]	VSD
C	S	1,00	1,11	50,8%	64,7	0,475	2685	292	1410	INCLUDED

* η_e (%) = Eff. (%) x Cc

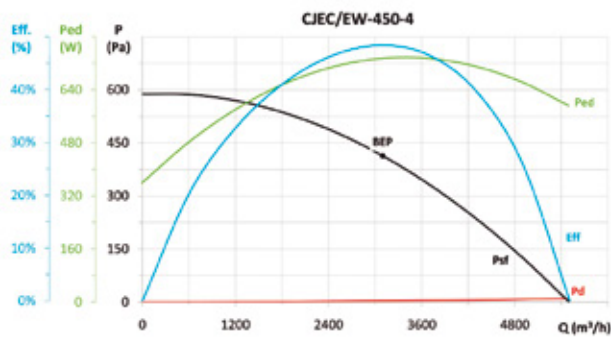

MC	EC	SR	Cc	η_e (%)*	N	[kW]	[m³/h]	[Pa]	[rpm]	VSD
C	S	1,00	1,10	53,1%	65,0	0,735	3097	414	1410	INCLUDED

* η_e (%) = Eff. (%) x Cc

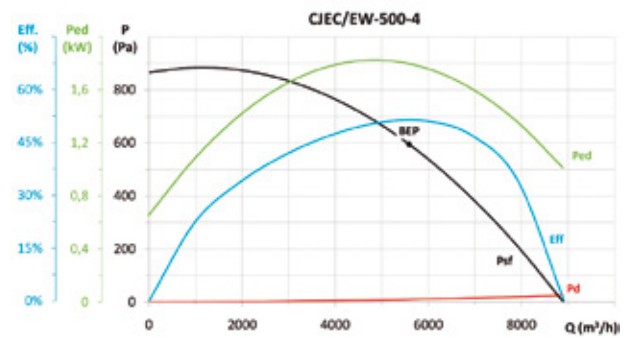

MC	EC	SR	Cc	η_e (%)*	N	[kW]	[m³/h]	[Pa]	[rpm]	VSD
C	S	1,01	1,07	55,0%	62,8	1,798	5587	595	1410	INCLUDED

* η_e (%) = Eff. (%) x Cc



Erp. Characteristic curves and ErP data

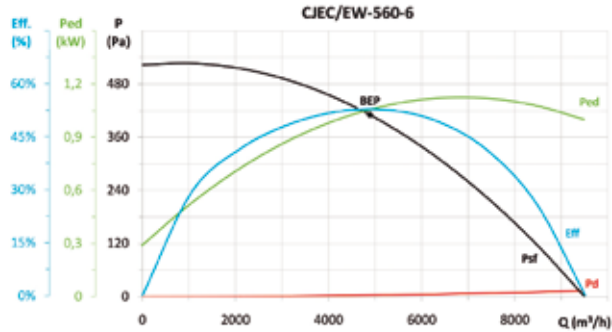

MC	EC	SR	Cc	η_a (%)*	N	[kW]	[m³/h]	[Pa]	[rpm]	VSD
C	S	1,00	1,09	57,4%	67,6	1,055	4889	410	960	INCLUDED

* η_{pe} (%) = Eff. (%) x Cc

CJEC installations

Possibility of installing the CJEC series by changing the position of the inlet and outlet panels

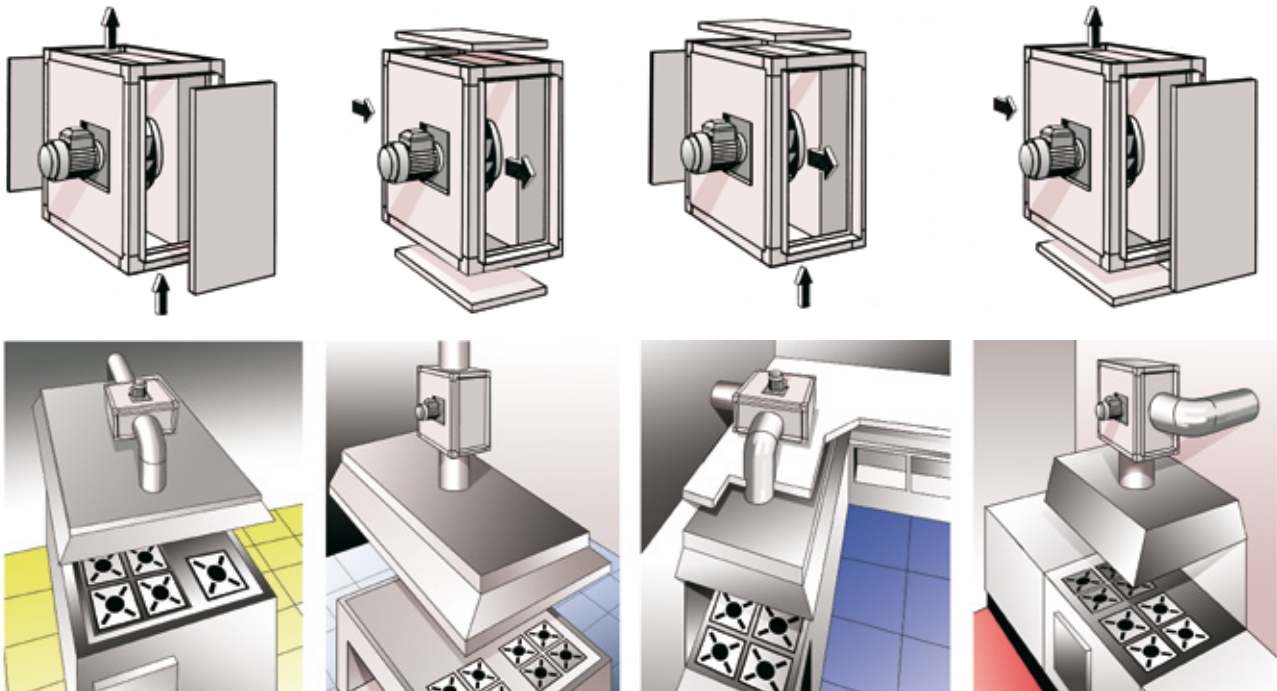

Accessories

See accessories section.



INT

CENTRAL CO

CONTROL UNITS
AND SENSORS



EFFICIENT WORK



CHT/EW CVT/EW



**INDUSTRIAL
BRUSHLESS
MOTOR E.C.**



CHT

CVT



VARIABLE SPEED DRIVE
VSD: Variable Speed Drive
Drive: VSD1/B
VSD3/B
Supply included with fan

CONTROL
Supply optional accessory

SUPPLY
VSD1/B:
220-240 V 50/60 Hz
VSD3/B:
380-415 V 50/60 Hz

400°C/2h centrifugal roof-mounted extractors with horizontal or vertical outlet air, fitted with industrial Brushless motor E.C.

CHT/EW: 400°C/2h centrifugal roof-mounted extractors with horizontal outlet air, hood in aluminium, fitted with industrial Brushless motor E.C.

CVT/EW: 400°C/2h centrifugal roof-mounted extractors with vertical outlet air, hood in aluminium, fitted with industrial Brushless motor E.C.

Fan:

- Galvanised sheet steel base plate.
- Impeller with backward-curved blades made from galvanised sheet steel
- Bird protection guard.
- Aluminium rain deflector hood

Motor and electronic variable speed:

- High-efficiency Industrial Brushless Motors E.C., fitted with electronic variable speed (VSD), adjustable via external control input 0-10V.
- It is advisable to install an electronic variable speed drive (VSD) outside the working area.
- The external signal can be supplied through a manual or automatic control with 0-10 V output.
- Electronic variable speed drive (VSD), available with single-phase 220-240 V 50/60 Hz input (VSD1/B type) or three-

phase 380-415 V 50/60 Hz (VSD3/B type).

- By default, the electronic variable speed drive (VSD) is delivered programmed for constant speed.
- Working fan temperature: -25 °C +60 °C.
- Working temperature (VSD): -25 °C +50 °C.

Finish:

- Anticorrosive galvanized sheet steel



Order code with variable speed drive (VSD) included

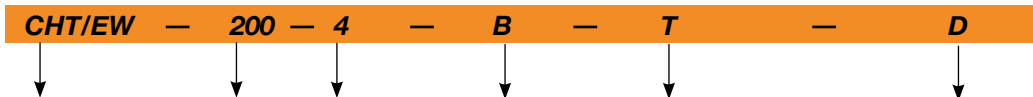

CHT/EW: 400°C/2h high-efficiency centrifugal roof fans, "Efficient work", with horizontal outlet air

Impeller size

Number of poles:
4=1410 r/min
6=960 r/min

Motors:
Industrial
Brushless E.C.

M: Fitted with VSD1/B, electronic variable speed, single phase power supply 220-240 V 50/60 Hz.

T: Fitted with VSD3/B, electronic variable speed, three-phase power supply 380-415 V 50/60 Hz.

D: Standard version, VSD supplied programmed for constant speed.
P: Supplied with VSD programmed for pressure control and Si-Presión pressure transmitter
K: Supplied with VSD programmed for pressure control and built into a BOXPRES KIT/B box.

CVT/EW: 400°C/2h high-efficiency centrifugal roof fans, "Efficient work", with vertical outlet air

Technical characteristics

Model	Speed min/max (r/min)	Single-phase VSD 230 V 50/60 Hz		Three-phase VSD 400 V 50/60 Hz		Maximum electrical power (W)	Maximum airflow min/max (m³/h)	Sound pressure level Lp dB(A)		Weight approx. (Kg)
		Maximum current input (A)	Model VSD	Maximum current input (A)	Model VSD			Inlet min/max	Outlet min/max	
CHT/EW CVT/EW 200-4	300 / 1410	1.14	VSD1/B-0.37	0.34	VSD3/B-0.75	140	310 / 1450	3 / 37	9 / 43	25
CHT/EW CVT/EW 225-4	300 / 1410	1.44	VSD1/B-0.37	0.42	VSD3/B-0.75	175	445 / 2100	7 / 41	13 / 47	25
CHT/EW CVT/EW 225-6	300 / 960	0.93	VSD1/B-0.37	0.27	VSD3/B-0.75	110	440 / 1400	5 / 30	11 / 36	26
CHT/EW CVT/EW 250-4	300 / 1410	2.79	VSD1/B-0.37	0.82	VSD3/B-0.75	340	660 / 3100	11 / 45	16 / 50	34
CHT/EW CVT/EW 250-6	300 / 960	1.17	VSD1/B-0.37	0.34	VSD3/B-0.75	140	625 / 2000	8 / 33	15 / 40	35
CHT/EW CVT/EW 315-4	300 / 1410	5.82	VSD1/B-0.75	1.37	VSD3/B-1.5	660	1055 / 4950	14 / 48	20 / 54	39
CHT/EW CVT/EW 315-6	300 / 960	2.13	VSD1/B-0.37	0.62	VSD3/B-0.75	255	1000 / 3200	12 / 37	18 / 43	39
CHT/EW CVT/EW 400-4	300 / 1410	7.94	VSD1/B-0.75	1.87	VSD3/B-1.5	905	1490 / 7000	21 / 55	27 / 61	57
CHT/EW CVT/EW 400-6	300 / 960	4.28	VSD1/B-0.75	1.00	VSD3/B-1.5	480	1405 / 4500	19 / 44	25 / 50	56
CHT/EW CVT/EW 450-4	300 / 1410	15.89	VSD1/B-1.5	3.74	VSD3/B-1.5	1825	2170 / 10200	25 / 59	30 / 64	66
CHT/EW CVT/EW 450-6	300 / 960	5.64	VSD1/B-0.75	1.32	VSD3/B-1.5	635	2155 / 6900	22 / 47	29 / 54	59
CHT/EW CVT/EW 500-6	300 / 960	11.51	VSD1/B-1.5	2.71	VSD3/B-1.5	1325	3750 / 12000	26 / 51	32 / 57	103



Acoustic features

The specified values are determined according to free field measurements of pressure and sound levels in dB(A) at a distance of 6 m.

Sound power Lw(A) spectrum in dB(A) via frequency band in Hz.

Inlet.									Outlet.								
Values taken at the inlet with 2/3 of the maximum airflow (2/3Qmax).									Values taken at outlet with 2/3 of the maximum airflow (2/3Qmax).								
Model	63	125	250	500	1000	2000	4000	8000	63	125	250	500	1000	2000	4000	8000	
200-4	35	41	52	55	56	52	50	44	39	44	58	60	61	61	56	51	
225-4	42	51	56	56	60	59	52	46	41	50	60	64	67	64	57	51	
225-6	31	40	45	45	49	48	41	35	30	39	49	53	56	53	46	40	
250-4	46	55	60	60	64	63	56	50	44	53	63	67	70	67	60	54	
250-6	34	43	48	48	52	51	44	38	34	43	53	57	60	57	50	44	
315-4	50	56	62	62	65	68	59	53	49	61	69	71	72	72	64	56	
315-6	39	45	51	51	54	57	48	42	38	50	58	60	61	61	53	45	
400-4	62	69	74	74	78	77	70	65	60	72	80	82	83	80	73	65	
400-6	46	52	58	58	61	64	55	49	45	57	65	67	68	68	60	52	
450-4	62	69	74	74	78	77	70	65	60	72	80	82	83	80	73	65	
450-6	50	57	62	62	66	65	58	53	50	62	70	72	73	70	63	55	
500-6	54	60	65	66	70	69	62	55	50	64	72	76	75	72	66	60	

Dimensions in mm

CHT/EW

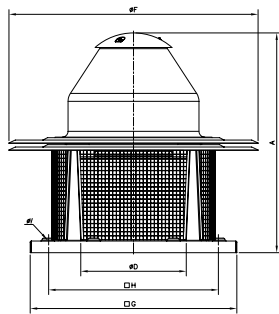

CHT/EW	A	øD*	øF	G	H	øl
200	552	250	570	450	360	12
225	570	250	570	450	360	12
250	632	355	726	560	450	12
315	682	355	726	560	450	12
400	755	500	856	710	590	12
450	770	500	856	710	590	12
500	846	630	1075	900	750	14

CVT/EW

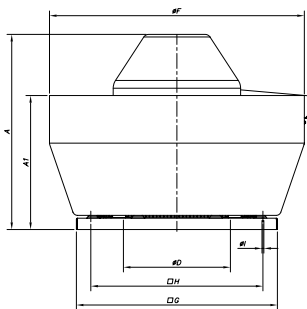

CVT/EW	A	A1	øD*	øF	G	H	øl
200	500	308	250	530	450	360	12
225	517	308	250	530	450	360	12
250	580	380	355	705	560	450	12
315	630	380	355	705	560	450	12
400	690	475	500	900	710	590	12
450	705	475	500	900	710	590	12
500	775	545	630	1100	900	750	14

Accessories

See accessories section



INT



BS
BSS



BAC



B



PA



MS



PT
PT/400



S



CONTROL UNITS
AND SENSORS



EFFICIENT WORK



Erp. Characteristic curves and ErP data

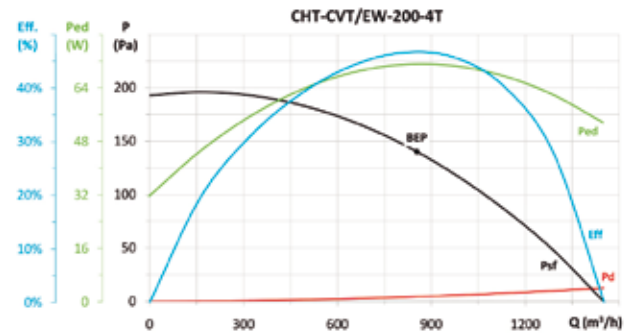

MC	EC	SR	Cc	η_b (%)*	N	[kW]	[m³/h]	[Pa]	[rpm]	VSD
C	S	-	-	-	-	0,071	853	140	1410	INCLUDED

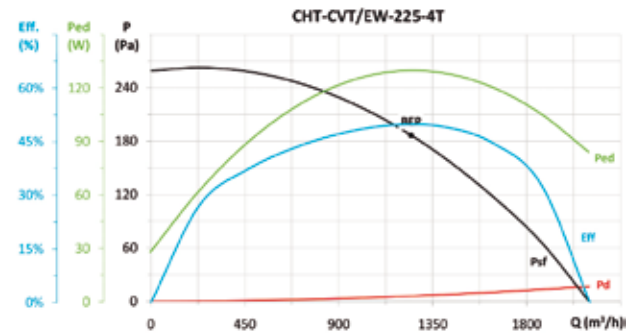

MC	EC	SR	Cc	η_b (%)*	N	[kW]	[m³/h]	[Pa]	[rpm]	VSD
C	S	1,00	1,15	57,3%	77,1	0,130	1247	187	1410	INCLUDED

* η_e (%) = Eff. (%) x Cc

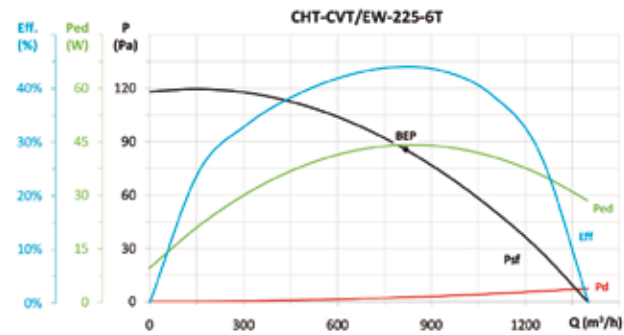

MC	EC	SR	Cc	η_b (%)*	N	[kW]	[m³/h]	[Pa]	[rpm]	VSD
C	S	-	-	-	-	0,044	818	86	960	INCLUDED

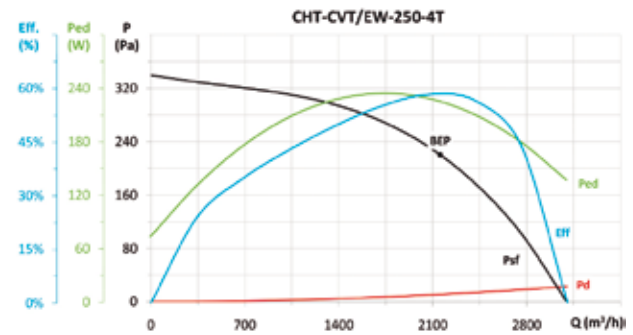

MC	EC	SR	Cc	η_b (%)*	N	[kW]	[m³/h]	[Pa]	[rpm]	VSD
C	S	1,00	1,13	66,3%	83,6	0,226	2156	220	1410	INCLUDED

* η_e (%) = Eff. (%) x Cc

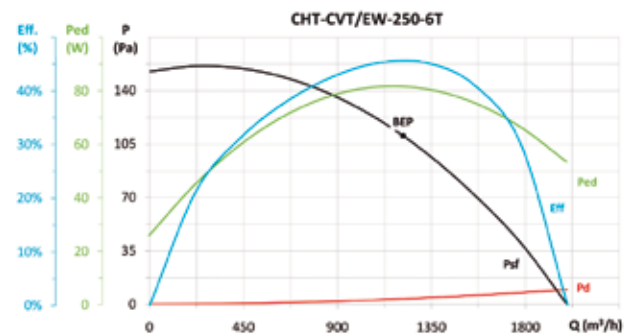

MC	EC	SR	Cc	η_b (%)*	N	[kW]	[m³/h]	[Pa]	[rpm]	VSD
C	S	-	-	-	-	0,082	1214	111	960	INCLUDED

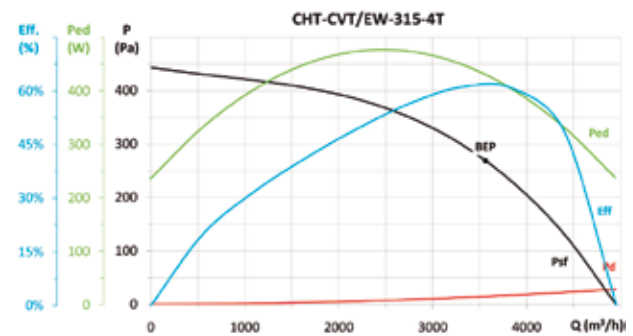

MC	EC	SR	Cc	η_b (%)*	N	[kW]	[m³/h]	[Pa]	[rpm]	VSD
C	S	1,00	1,11	68,8%	83,1	0,431	3562	269	1410	INCLUDED

* η_e (%) = Eff. (%) x Cc

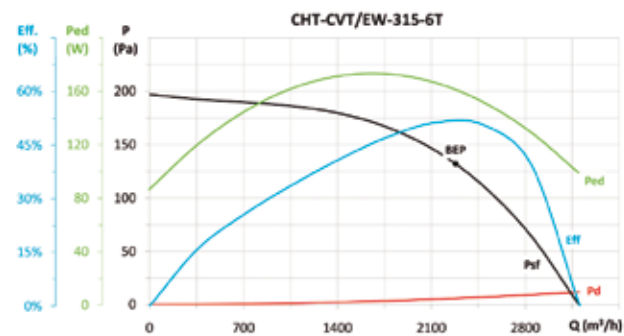

MC	EC	SR	Cc	η_b (%)*	N	[kW]	[m³/h]	[Pa]	[rpm]	VSD
C	S	1,00	1,14	59,2%	78,0	0,161	2281	132	960	INCLUDED

* η_e (%) = Eff. (%) x Cc

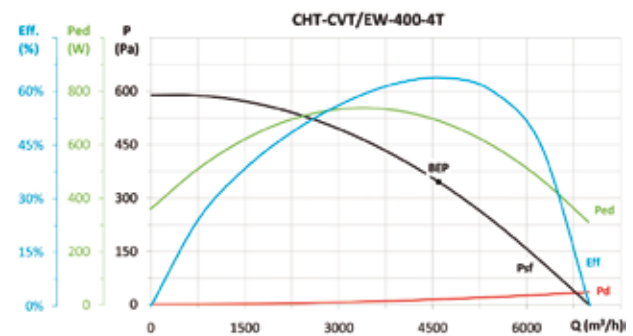

MC	EC	SR	Cc	η_b (%)*	N	[kW]	[m³/h]	[Pa]	[rpm]	VSD
C	S	1,00	1,10	70,2%	82,4	0,691	4594	345	1410	INCLUDED

* η_e (%) = Eff. (%) x Cc



Erp. Characteristic curves and ErP data

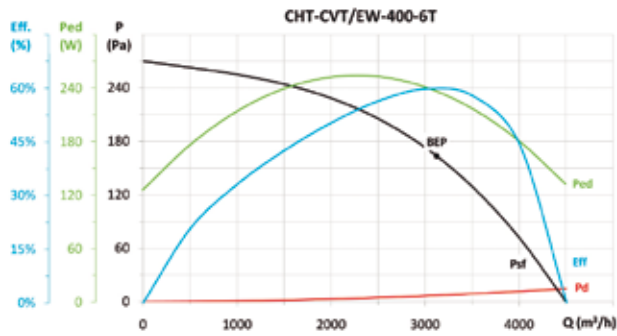

MC	EC	SR	Cc	η_b (%)*	N	[kW]	[m³/h]	[Pa]	[rpm]	VSD
C	S	1,00	1,13	67,9%	84,9	0,237	3124	164	960	INCLUDED

* η_e (%) = Eff. (%) x Cc

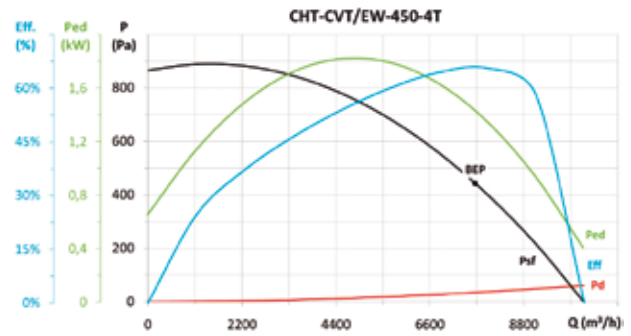

MC	EC	SR	Cc	η_b (%)*	N	[kW]	[m³/h]	[Pa]	[rpm]	VSD
C	S	1,00	1,08	70,8%	79,7	1,434	7663	443	1410	INCLUDED

* η_e (%) = Eff. (%) x Cc

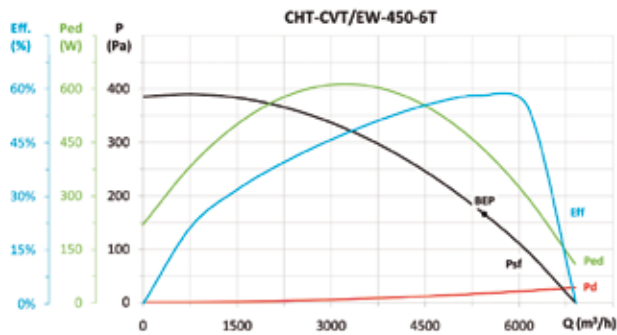

MC	EC	SR	Cc	η_b (%)*	N	[kW]	[m³/h]	[Pa]	[rpm]	VSD
C	S	1,00	1,11	64,8%	79,2	0,430	5449	165	960	INCLUDED

* η_e (%) = Eff. (%) x Cc

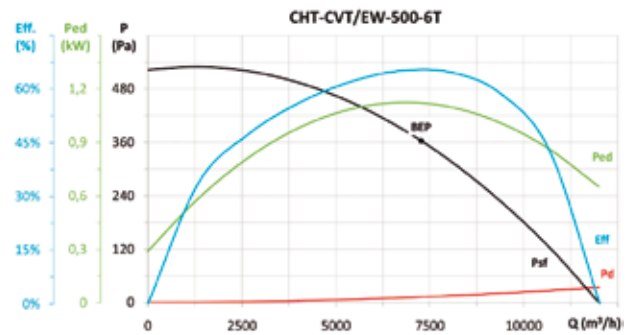

MC	EC	SR	Cc	η_b (%)*	N	[kW]	[m³/h]	[Pa]	[rpm]	VSD
C	S	1,00	1,08	71,0%	81,0	1,121	7265	364	960	INCLUDED

* η_e (%) = Eff. (%) x Cc



EFFICIENT WORK



HT-L/EW



INDUSTRIAL BRUSHLESS MOTOR E.C.



VARIABLE SPEED DRIVE
VSD: Variable Speed Drive.
• VSD1/B
• VSD3/B

Supply included with fan

CONTROL
Supply optional accessory

SUPPLY
VSD1/B:
220-240 V 50/60 Hz
VSD3/B:
380-415 V 50/60 Hz

Axial roof fans with flat base fitted with industrial Brushless motor E.C.

Fan:

- Galvanised sheet steel base plate.
- Impeller in polyamide 6 reinforced with fibreglass.
- Bird protection guard
- Sheet steel rain deflector hood with anticorrosive protection
- Airflow direction from motor to impeller.

Motor and electronic variable speed:

- High-efficiency Industrial Brushless Motors E.C., fitted with electronic variable speed (VSD), adjustable via external control input 0-10V.
- It is advisable to install an electronic variable speed drive (VSD) outside the working area.
- The external signal can be supplied through a manual or automatic control with 0-10 V output.
- Electronic variable speed drive (VSD), available with single-phase 220-240 V 50/60 Hz input (VSD1/B type) or three-phase 380-415 V 50/60 Hz (VSD3/B type).

- By default, the electronic variable speed drive (VSD) is delivered programmed for constant speed.
- Working fan temperature: -25 °C +60 °C.
- Working temperature (VSD): -25 °C +50 °C.

Finish:

- Anticorrosive finish in polyester resin polymerised at 190°C, after alkaline degreasing with nanotechnology treatment and phosphate-free.

On request:

- Possibility of supply as IMPULSION FANS
- AL version cast aluminium impeller.

Order code with variable speed drive (VSD) included

HT-L/EW — 25 — 4 — B — T — — D

HT-L/EW: Highly-efficient axial roof fans with flat base, "Efficient work"

Impeller diameter in cm.

Number of poles:
4=1410 r/min
6=960 r/min

Industrial Brushless Motors E.C.

M: Fitted with VSD1/B, electronic variable speed, single phase power supply 220-240 V 50/60 Hz.

T: Fitted with VSD3/B, electronic variable speed, three-phase power supply 380-415 V 50/60 Hz.

D: Standard version, VSD supplied programmed for constant speed.
P: Supplied with VSD programmed for pressure control and Si-Presión pressure transmitter
K: Supplied with VSD programmed for pressure control and built into a BOXPRES KIT/B box.

Technical characteristics

Model	Speed min/max (r/min)	Single-phase VSD 230 V 50/60 Hz		Three-phase VSD 400 V 50/60 Hz		Maximum electrical power (W)	Maximum airflow min/max (m³/h)	Sound pressure level		Weight approx. (Kg)
		Maximum current input (A)	Model VSD	Maximum current input (A)	Model VSD			Inlet min/max Lp dB(A)	Outlet min/max Lp dB(A)	
HT-L/EW-25-4	300 / 1410	1.44	VSD1/B-0.37	0.42	VSD3/B-0.75	175	230 / 1080	7 / 41	6 / 40	12.5
HT-L/EW-31-4	300 / 1410	1.44	VSD1/B-0.37	0.42	VSD3/B-0.75	175	385 / 1800	13 / 47	12 / 46	13.5
HT-L/EW-35-4	300 / 1410	1.44	VSD1/B-0.37	0.42	VSD3/B-0.75	175	555 / 2600	14 / 48	13 / 47	17.5
HT-L/EW-40-4	300 / 1410	2.79	VSD1/B-0.37	0.82	VSD3/B-0.75	340	980 / 4600	17 / 51	16 / 50	21
HT-L/EW-45-4	300 / 1410	3.96	VSD1/B-0.37	0.93	VSD3/B-0.75	450	1385 / 6500	21 / 55	20 / 54	30.5
HT-L/EW-50-4	300 / 1410	5.82	VSD1/B-0.75	1.37	VSD3/B-1.5	660	1810 / 8500	25 / 59	23 / 57	39
HT-L/EW-56-4	300 / 1410	7.94	VSD1/B-0.75	1.87	VSD3/B-1.5	905	2085 / 9800	27 / 61	23 / 57	37
HT-L/EW-56-6	300 / 960	2.93	VSD1/B-0.37	0.68	VSD3/B-0.75	330	2065 / 6600	23 / 48	21 / 46	46
HT-L/EW-63-4	300 / 1410	11.25	VSD1/B-0.75	2.65	VSD3/B-1.5	1295	2980 / 14000	29 / 63	25 / 59	65.8
HT-L/EW-63-6	300 / 960	4.28	VSD1/B-0.75	1.00	VSD3/B-1.5	480	2875 / 9200	27 / 52	24 / 49	61.8

Acoustic features at maximum speed

The specified values are determined according to free field measurements of pressure and sound levels in dB(A) at a distance of 6 m.

Sound power $L_w(A)$ spectrum in dB(A) via frequency band in Hz.

Inlet								Outlet								
Model	63	125	250	500	1000	2000	4000	8000	63	125	250	500	1000	2000	4000	8000
HT-L/EW-25-4	27	37	54	54	62	58	51	42	26	36	53	53	61	57	50	41
HT-L/EW-31-4	33	43	60	60	68	64	57	48	32	42	59	59	67	63	56	47
HT-L/EW-35-4	34	44	61	61	69	65	58	49	33	43	60	60	68	64	57	48
HT-L/EW-40-4	28	45	57	65	70	70	66	59	27	44	56	64	69	69	65	58
HT-L/EW-45-4	32	49	61	69	74	74	70	63	30	47	59	67	72	72	68	61
HT-L/EW-50-4	36	53	65	73	78	78	74	67	34	51	63	71	76	76	72	65
HT-L/EW-56-4	38	55	67	75	80	80	76	69	34	51	63	71	76	76	72	65
HT-L/EW-56-6	25	42	54	62	67	67	63	56	23	40	52	60	65	65	61	54
HT-L/EW-63-4	40	57	69	77	82	82	78	71	36	53	65	73	78	78	74	67
HT-L/EW-63-6	29	46	58	66	71	71	67	60	26	43	55	63	68	68	64	57

Dimensions in mm

Model	A	B	C	D	E	ØF	G	H	ØI	ØJ
HT-L/EW-25-4	400	176	44	40	140	620	450	360	12	346
HT-L/EW-31-4	423	176	67	40	140	620	500	410	12	416
HT-L/EW-35-4	472	228	64	40	140	770	560	450	12	486
HT-L/EW-40-4	478	228	82	40	128	770	630	530	12	536
HT-L/EW-45-4	512	266	88	50	108	960	710	590	12	596
HT-L/EW-50-4	558	296	83	50	129	1090	800	680	12	676
HT-L/EW-56-4	590	296	117	40	137	1090	900	750	14	758
HT-L/EW-56-6	589	296	117	40	136	1090	900	750	14	758
HT-L/EW-63-4	714	357	136	40	182	1285	1000	850	14	735
HT-L/EW-63-6	667	357	136	40	135	1285	1000	850	14	735

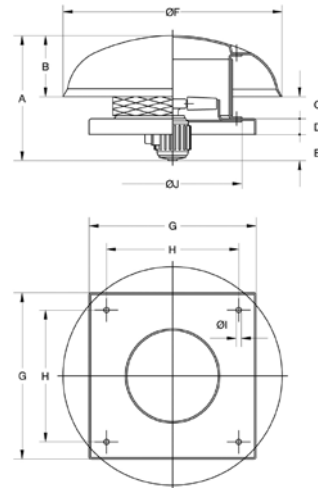

Accessories

See accessories section.



INT



BTUB



MS



PA



OP



S



BS
BSS



CONTROL UNITS
AND SENSORS



Erp. Characteristic curves and ErP data

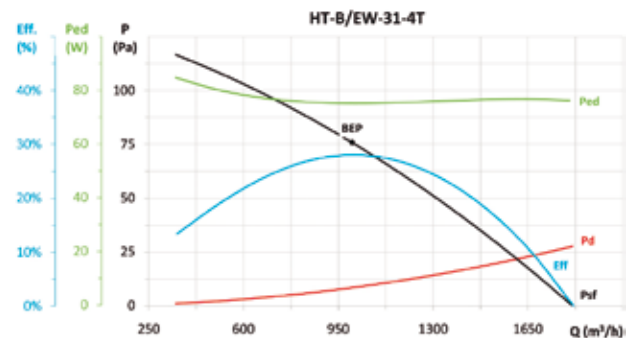
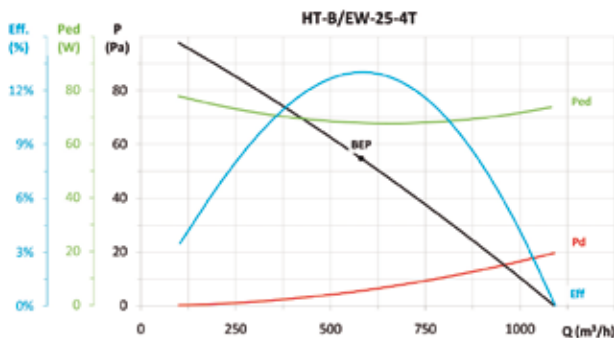



EFFICIENT WORK



Erp. Characteristic curves and ErP data

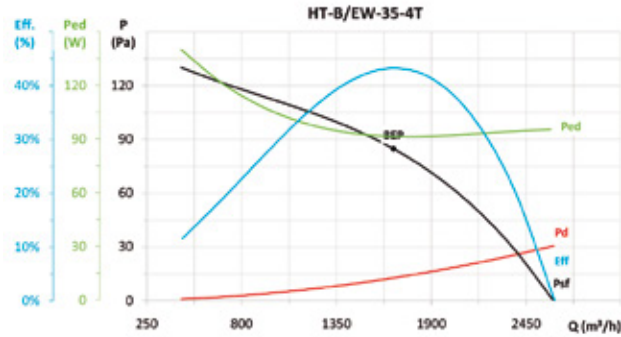

MC	EC	SR	Cc	η_e (%)*	N	[kW]	[m³/h]	[Pa]	[rpm]	VSD
A	S	-	-	-	-	0,091	1681	85	1410	INCLUDED

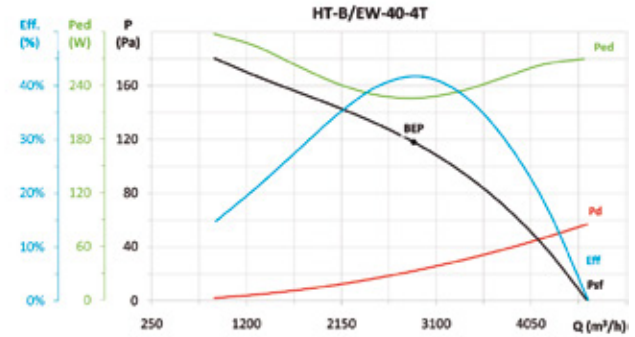

MC	EC	SR	Cc	η_e (%)*	N	[kW]	[m³/h]	[Pa]	[rpm]	VSD
A	S	1,00	1,13	47,2%	57,7	0,226	2875	118	1410	INCLUDED

* η_e (%) = Eff. (%) x Cc

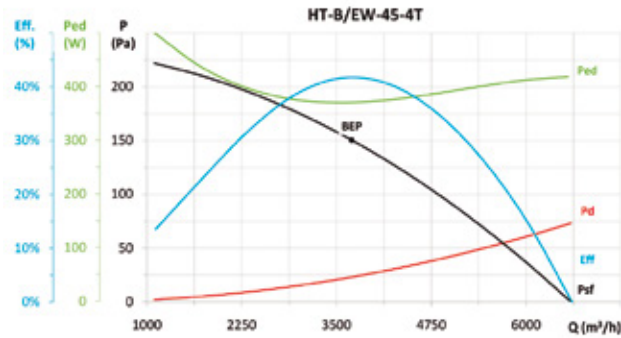

MC	EC	SR	Cc	η_e (%)*	N	[kW]	[m³/h]	[Pa]	[rpm]	VSD
A	S	1,00	1,12	46,7%	55,7	0,370	3701	150	1410	INCLUDED

* η_e (%) = Eff. (%) x Cc

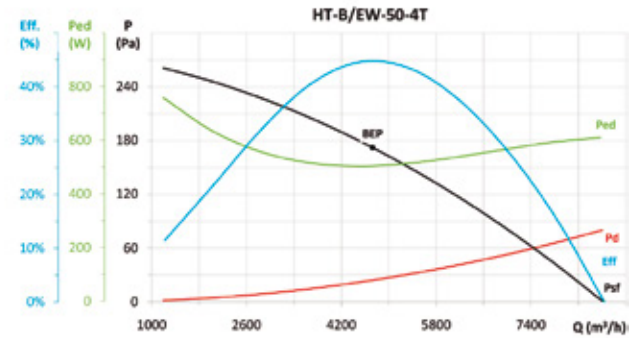

MC	EC	SR	Cc	η_e (%)*	N	[kW]	[m³/h]	[Pa]	[rpm]	VSD
A	S	1,00	1,11	49,6%	57,8	0,505	4727	172	1410	INCLUDED

* η_e (%) = Eff. (%) x Cc

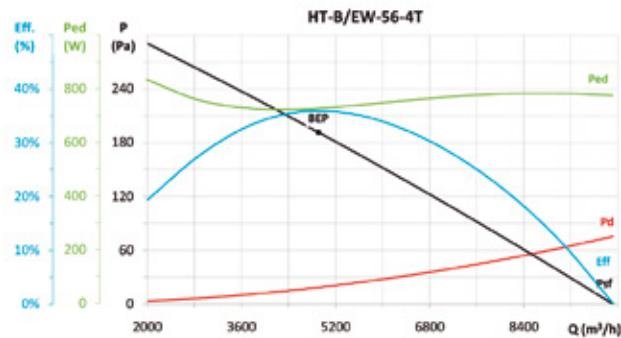

MC	EC	SR	Cc	η_e (%)*	N	[kW]	[m³/h]	[Pa]	[rpm]	VSD
A	S	1,00	1,10	39,4%	46,6	0,727	4907	192	1410	INCLUDED

* η_e (%) = Eff. (%) x Cc

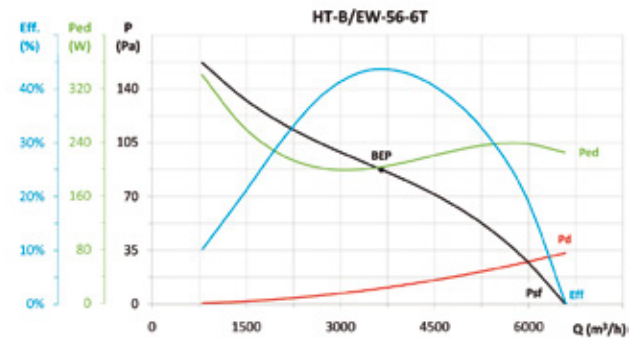

MC	EC	SR	Cc	η_e (%)*	N	[kW]	[m³/h]	[Pa]	[rpm]	VSD
A	S	1,00	1,14	49,6%	60,3	0,203	3651	87	960	INCLUDED

* η_e (%) = Eff. (%) x Cc

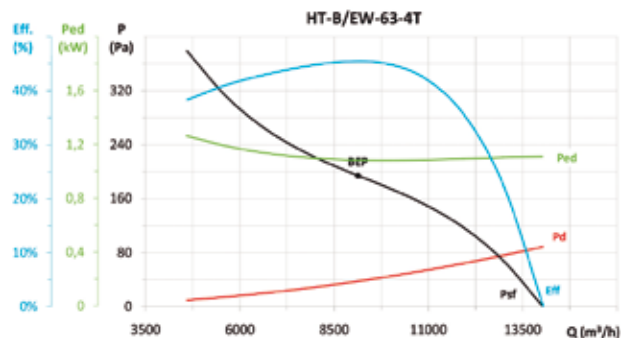

MC	EC	SR	Cc	η_e (%)*	N	[kW]	[m³/h]	[Pa]	[rpm]	VSD
C	S	1,00	1,09	49,4%	55,5	1,083	9132	194	1410	INCLUDED

* η_e (%) = Eff. (%) x Cc

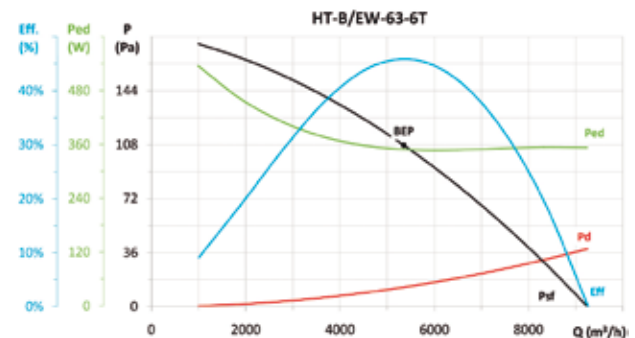

MC	EC	SR	Cc	η_e (%)*	N	[kW]	[m³/h]	[Pa]	[rpm]	VSD
A	S	1,00	1,12	51,4%	60,6	0,349	5352	108	960	INCLUDED

* η_e (%) = Eff. (%) x Cc

HT/EW

**HIGHLY EFFICIENT
IE3-COMPLIANT
THREE-PHASE MOTORS**

High-efficiency axial roof fans with flat base fitted with IE3 asynchronous motor adjustable electronically.



Fan:

- Galvanised sheet steel base plate.
- Impeller in polyamide 6 reinforced with fibreglass, except models 100 of 4 poles in aluminium.
- Bird protection guard
- Rain deflector hood in polyester, except model 71 in sheet steel with anticorrosive protection.
- Airflow direction from motor to impeller.



VARIABLE SPEED DRIVE
VSD: Variable Speed Drive.
: VSD1/A-RFM
: VSD3/A-RFT
Supply on request

CONTROL
Supply optional accessory

SUPPLY
VSD31A-RFT:
220-240 V 50/60 Hz
VSD3/A-RFT:
380-415 V 50/60 Hz

Motor and electronic variable speed:

- Motors with IE3 efficiency adjustable electronically.
- The variable speed drive VSD will be supplied as per order.
- Electronic variable speed drive (VSD) can be adjusted by external 0-10 V signal.
- It is advisable to install sinusoidal filters between the fan and the electronic variable speed drive (VSD) when they are far apart.
- Electronic variable speed drive (VSD), available with single-phase 220-240 V 50/60 Hz input (VSD1/B type) or three-phase 380-415 V 50/60 Hz (VSD3/B type).
- By default, the electronic variable speed drive (VSD) is delivered programmed for constant speed.
- Working fan temperature: -25 °C +60 °C.

Working temperature (VSD):

- -25 °C +50 °C.
- Class F motors with ball bearings, IP55 protection.
- Three-phase 230/400 V. 50 Hz. (up to 5.5 CV.) and 400/690 V. 50 Hz. (power over 5.5 CV.)

On request:

- Possibility of supply as IMPULSION FANS
- AL version cast aluminium impeller.

Fan order code

HT/EW — 71 — 4T — 2 — IE3

HT/EW: Highly-efficient axial roof fans with flat base, "Efficient work"

Impeller diameter in cm.

Number of poles:
4=1410 r/min
6=960 r/min

Motor power (CV)

Three-phase motors IE3

HT/EW — 71 — 4T — 2 — IE3 — VSD1 — D

HT/EW: Highly-efficient axial roof fans with flat base, "Efficient work"

Impeller diameter in cm.

Number of poles:
4=1410 r/min
6=960 r/min

Motor power (CV)

Three-phase motor IE3

VSD1: Fitted with VSD1/A-RFM, electronic variable speed, single phase power supply 220-240 V 50/60 Hz.

VSD3: Fitted with VSD3/A-RFT, electronic variable speed, three-phase power supply 380-415 V 50/60 Hz.

D: Standard version, VSD supplied programmed for constant speed.
P: Supplied with VSD programmed for pressure control and Si-Presión pressure transmitter
K: Supplied with VSD programmed for pressure control and built into a BOXPRES KIT/B box.
Only available for fans with motor power less than or equal to 2.2 kW.

Accessories

See accessories section.



INT

VSD1/A-RFM
VSD3/A-RFT

AET

BTUB

MS

PA

OP

S

BS
BSS

CONTROL UNITS
AND SENSORS



EFFICIENT WORK



Technical characteristics

Model	Speed min/max (r/min)	Single-phase VSD 230 V 50/60 Hz		Three-phase VSD 400 V 50/60 Hz		Maximum current Motor 50 Hz 400V 690V (A)			Installed power (kW)	Maximum airflow min/max (m³/h)	Sound pressure level Inlet min/max Lp dB(A)		Weight approx. (Kg)
		Maximum current input (A)	Model VSD	Maximum current input (A)	Model VSD								
HT/EW-71-4T-2	575/1440	15.78	VSD1/A-RFM-2	4.38	VSD3/A-RFT-2	5.41	3.11	-	1.50	7190 / 18000	49 / 69	47 / 67	64.0
HT/EW-71-6T-0.75	370/925	6.90	VSD1/A-RFM-1	1.92	VSD3/A-RFT-1	2.52	1.45	-	0.55	4880 / 12200	38 / 58	36 / 56	64.9
HT/EW-80-4T-3	575/1435	23.15	VSD1/A-RFM-3	6.43	VSD3/A-RFT-3	7.93	4.56	-	2.20	10500 / 26200	53 / 73	50 / 70	87.8
HT/EW-80-6T-1.5	380/945	12.43	VSD1/A-RFM-2	3.45	VSD3/A-RFT-2	4.68	2.69	-	1.10	7240 / 18000	44 / 64	41 / 61	81.8
HT/EW-90-4T-4	575/1440	-	-	7.20	VSD3/A-RFT-5.5	10.7	6.15	-	3.00	12580 / 31500	57 / 77	54 / 74	94.0
HT/EW-90-6T-2	380/950	16.64	VSD1/A-RFM-2	4.62	VSD3/A-RFT-2	6.43	3.7	-	1.50	8480 / 21200	48 / 68	45 / 65	91.0
HT/EW-100-4T-7.5	585/1465	-	-	12.81	VSD3/A-RFT-7.5	-	10.3	5.97	5.50	14775 / 37000	60 / 80	57 / 77	114.0
HT/EW-100-4T-10	585/1465	-	-	17.32	VSD3/A-RFT-10	-	13.9	8.06	7.50	17570 / 44000	64 / 84	61 / 81	125.0
HT/EW-100-6T-2	380/950	16.64	VSD1/A-RFM-2	4.62	VSD3/A-RFT-2	6.43	3.7	-	1.50	10000 / 25000	51 / 71	48 / 68	102.0
HT/EW-100-6T-3	380/950	23.83	VSD1/A-RFM-3	6.62	VSD3/A-RFT-3	9.08	5.22	-	2.20	11280 / 28200	55 / 75	52 / 72	106.0

Acoustic features at maximum speed

The specified values are determined according to free field measurements of pressure and sound levels in dB(A) at a distance of 6 m.

Sound power Lw(A) spectrum in dB(A) via frequency band in Hz.

Model	Inlet								Outlet							
	63	125	250	500	1000	2000	4000	8000	63	125	250	500	1000	2000	4000	8000
HT/EW-71-4T	46	63	75	83	88	88	84	77	44	61	73	81	86	86	82	75
HT/EW-71-6T	35	52	64	72	77	77	73	66	33	50	62	70	75	75	71	64
HT/EW-80-4T	57	78	85	90	93	89	82	71	54	75	82	87	90	86	79	68
HT/EW-80-6T	48	69	76	81	84	80	73	62	45	66	73	78	81	77	70	59
HT/EW-90-4T	61	82	89	94	97	93	86	75	58	79	86	91	94	90	83	72
HT/EW-90-6T	52	73	80	85	88	84	77	66	49	70	77	82	85	81	74	63
HT/EW-100-4T-7,5	64	85	92	97	100	96	89	78	61	82	89	94	97	93	86	75
HT/EW-100-4T-10	68	89	96	101	104	100	93	82	65	86	93	98	101	97	90	79
HT/EW-100-6T-2	55	76	83	88	91	87	80	69	52	73	80	85	88	84	77	66
HT/EW-100-6T-3	59	80	87	92	95	91	84	73	56	77	84	89	92	88	81	70

Dimensions in mm

Model	A	B	C	D	E	ØF	G	H	ØI	ØJ
HT/EW-71-4T	740	357	166	40	178	1285	1000	850	14	815
HT/EW-71-6T	689	357	166	40	178	1285	1000	850	14	815
HT/EW-80-4T	840	357	244	50	189	1285	1150	1000	14	905
HT/EW-80-6T	804	357	244	50	153	1285	1150	1000	14	905
HT/EW-90-4T	892	440	213	50	189	1580	1150	1000	14	1020
HT/EW-90-6T	896	440	213	50	193	1580	1150	1000	14	1020
HT/EW-100-4T	997	440	284	50	223	1580	1250	1100	14	1120
HT/EW-100-6T-2	940	440	284	50	166	1580	1250	1100	14	1120
HT/EW-100-6T-3	957	440	284	50	183	1580	1250	1100	14	1120

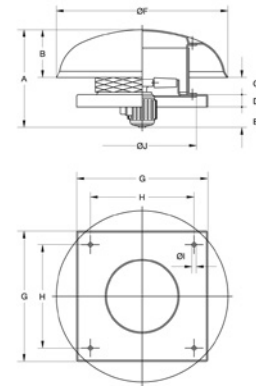

Erp. Characteristic curves and ErP data

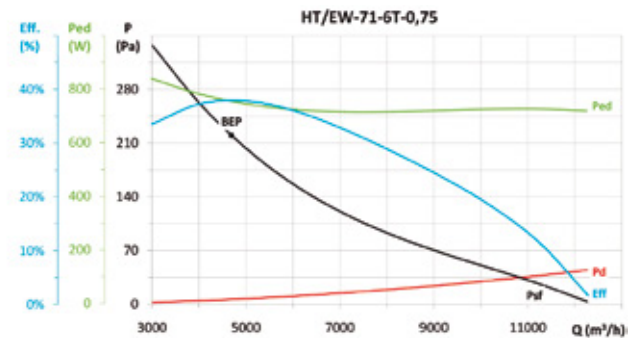
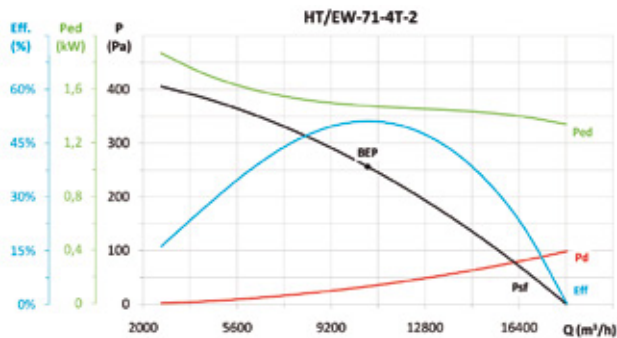

MC	EC	SR	Cc	η _e (%)*	N	[kW]	[m³/h]	[Pa]	[rpm]	VSD
C	S	1,00	1,08	55,0%	60,3	1,476	10600	256	1451	NECESSARY

*η_e (%) = EFF. (%) x Cc

MC	EC	SR	Cc	η _e (%)*	N	[kW]	[m³/h]	[Pa]	[rpm]	VSD
C	S	1,00	1,10	41,6%	48,7	0,755	4694	220	929	NECESSARY

*η_e (%) = EFF. (%) x Cc

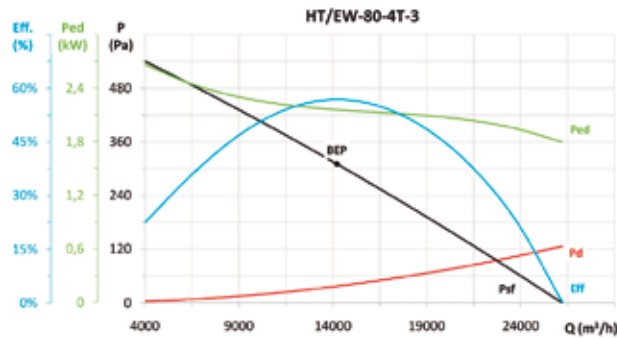
Erp. Characteristic curves and ErP data

MC	EC	SR	Cc	η_b (%)*	N	[kW]	[m³/h]	[Pa]	[rpm]	VSD
C	S	1,00	1,06	60,5%	64,7	2,159	14211	311	1447	NECESSARY

* η_e (%) = Eff. (%) x Cc

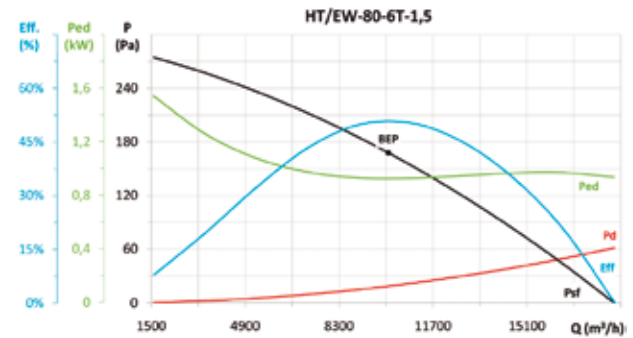

MC	EC	SR	Cc	η_b (%)*	N	[kW]	[m³/h]	[Pa]	[rpm]	VSD
C	S	1,00	1,09	55,4%	62,0	0,924	10084	168	964	NECESSARY

* η_e (%) = Eff. (%) x Cc

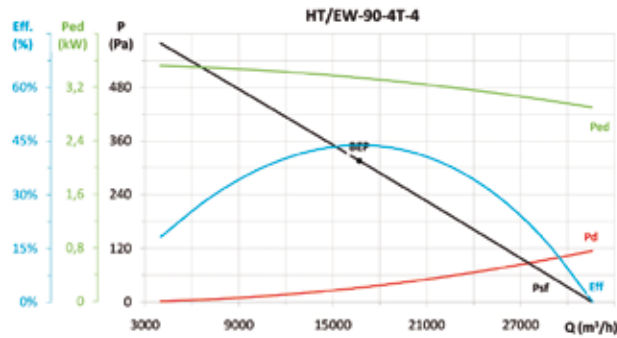

MC	EC	SR	Cc	η_b (%)*	N	[kW]	[m³/h]	[Pa]	[rpm]	VSD
C	S	1,00	1,05	46,1%	49,1	3,342	16694	316	1444	NECESSARY

* η_e (%) = Eff. (%) x Cc

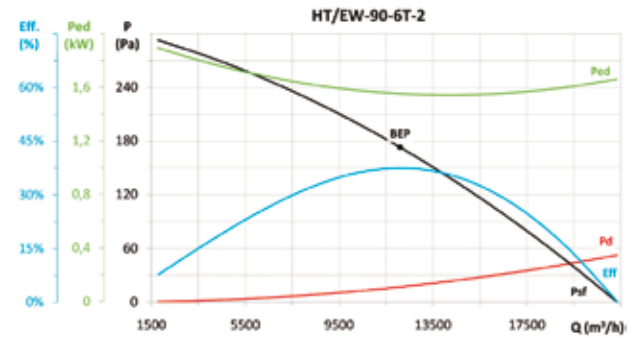

MC	EC	SR	Cc	η_b (%)*	N	[kW]	[m³/h]	[Pa]	[rpm]	VSD
C	S	1,00	1,07	40,3%	45,4	1,552	12101	173	959	NECESSARY

* η_e (%) = Eff. (%) x Cc

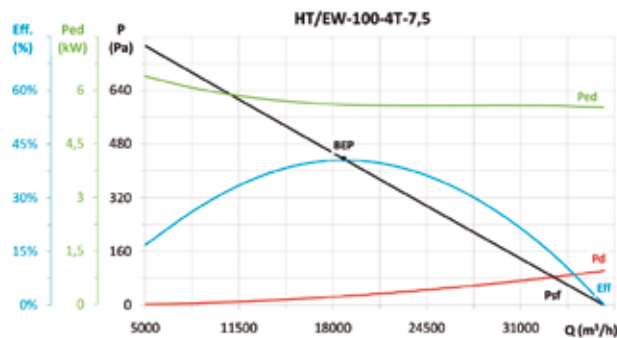

MC	EC	SR	Cc	η_b (%)*	N	[kW]	[m³/h]	[Pa]	[rpm]	VSD
C	S	1,00	1,07	41,5%	46,2	1,754	13902	176	954	NECESSARY

* η_e (%) = Eff. (%) x Cc

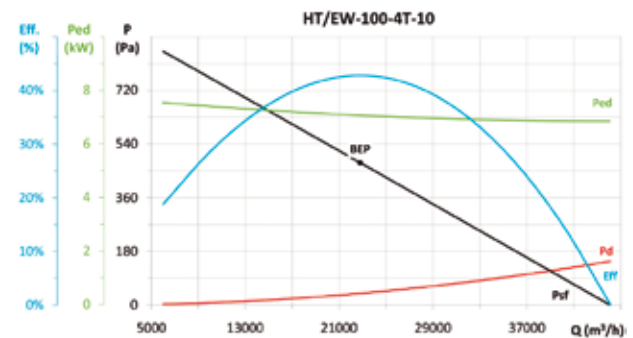

MC	EC	SR	Cc	η_b (%)*	N	[kW]	[m³/h]	[Pa]	[rpm]	VSD
C	S	1,00	1,06	37,8%	41,8	2,328	15556	192	958	NECESSARY

* η_e (%) = Eff. (%) x Cc

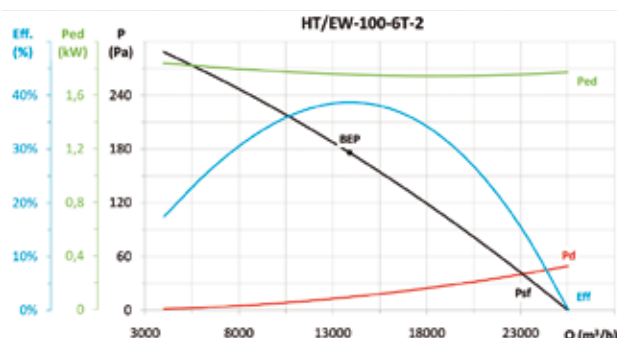

MC	EC	SR	Cc	η_b (%)*	N	[kW]	[m³/h]	[Pa]	[rpm]	VSD
C	S	1,00	1,06	37,8%	41,8	2,328	15556	192	958	NECESSARY

* η_e (%) = Eff. (%) x Cc

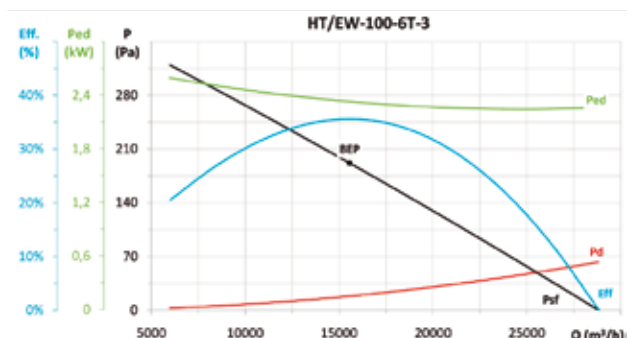

MC	EC	SR	Cc	η_b (%)*	N	[kW]	[m³/h]	[Pa]	[rpm]	VSD
C	S	1,00	1,06	37,8%	41,8	2,328	15556	192	958	NECESSARY

* η_e (%) = Eff. (%) x Cc



EFFICIENT WORK



OVERPRESSURE KIT

The system of pressurisation of staircases, escape routes or of confinement makes it possible to control the airflow automatically and to maintain a differential pressure of 50 Pa in a single stage, according to standard UNE EN 12101-6-2006.

STAIRWELL OVERPRESSURE KIT
Three-phase equipment



STAIRWELL OVERPRESSURE KIT
For single-phase equipment



OVERPRESSURE KIT WITH
RESERVE FAN



STAIRWELL OVERPRESSURE KIT

- Stairwell overpressure kit made up of control panel (BOXPRES KIT) and outlet units (CJHCH or CJBD), for the pressurisation of the stairwells and escape routes. Also available for single-phase equipment's NEOLINEO Y CJBC.

OVERPRESSURE KIT WITH RESERVE FAN

- Overpressure kit with reserve fan, made up of control panel (BOXPRES KIT II), which incorporates a system of automatic switching to keep the overpressure in the case of a stop by the main fan and TWIN or CJHCH/DUPLEX air outlet units with reserve fan.

BOXPRES



- Easy to install
- Compact and self-sufficient solution
- Preventive maintenance
- Easy starting
- Safe and functional installation



- The proper operation of the pressurisation systems depends not only on correct design but also on the proper regulation carried out by the system with the result that it is of vital importance to have calibrated and highly-precise regulation elements which make it possible to have the two situations in the case of fire, in a rapid and stable manner.
- The BOXPRES control panel, apart from satisfying the most demanding requirements, simplifies the work of the installer to the greatest possible extent.

Includes:

- Frequency variator programmed to 50 Pa
- Differential pressure probe
- Magneto thermal
- Line LED and fault
- Check button

BOXPRES is a piece of equipment with all its interconnections made and tested

- Ready to work and carry out its duties on the pressure control of the installation.
- Possibility of checking the installation so as to prevent faults
- Only the power cable, the impulsion fan and the fire signal should be connected.

The panels for single-phase equipment include:

- Voltage regulator programmed to 50 Pa
- Differential pressure probe external to the equipment.

Order code

OVERPRESSURE KIT — 7.100



Kit sobrepresión: Overpressure set for staircases
Kit sobrepresión II: Overpressure set with reserve fan



Maximum airflow

Technical characteristics

Model	Power supply	Output	Outlet unit	Airflow (m ³ /h)	Irradiated sound level* dB(A)
KIT SOBREPRESION-1060-LED	230 Vac II	230 Vac II	NEOLINEO-200	1060	38
KIT SOBREPRESION-2300-LED	230 Vac II	230 Vac II	NEOLINEO-315	2300	47
KIT SOBREPRESION-2880-LED	230 Vac II	230 Vac II	CJBC-2828-6M 1/3	2880	61
KIT SOBREPRESION-7100-LED	230 Vac II	230 Vac III	CJHCH-45-4T-0.5	7100	55
KIT SOBREPRESION-7800-LED	230 Vac II	230 Vac III	CJBD-3333-6T -1.5	7800	55
KIT SOBREPRESION-12900-LED	230 Vac II	230 Vac III	CJHCH-56-4T-1	12900	60
KIT SOBREPRESION-17000-LED	230 Vac II	230 Vac III	CJHCH-63-4T-1.5	17000	61
KIT SOBREPRESION-7100-BOX	400 Vac III	400 Vac III	CJHCH-45-4T-0.5	7100	55
KIT SOBREPRESION-7800-BOX	400 Vac III	400 Vac III	CJBD-3333-6T -1.5	7800	55
KIT SOBREPRESION-12900-BOX	400 Vac III	400 Vac III	CJHCH-56-4T-1	12900	60
KIT SOBREPRESION-17000-BOX	400 Vac III	400 Vac III	CJHCH-63-4T-1.5	17000	61
KIT SOBREPRESION II-6240-BOX	400 Vac III	400 Vac III	TWIN-12/12-6T-1.5	6240	55
KIT SOBREPRESION II-9520-BOX	400 Vac III	400 Vac III	TWIN-15/15-6T-3	9520	54
KIT SOBREPRESION II-12900-BOX	400 Vac III	400 Vac III	CJHCH/DUPLEX-56-4T-1-H	12900	60
KIT SOBREPRESION II-17000-BOX	400 Vac III	400 Vac III	CJHCH/DUPLEX-63-4T-1.5-H	17000	61
SONDA TPDA SI-PRESIÓN c/DISPLAY					
SONDA TPDA 984M.523 P04					
SONDA TPDA 984M.523 P14 LED					
BOXPRES KIT-3A 230Vac	230 Vac II	230 Vac II			
BOXPRES KIT-10A 230Vac	230 Vac II	230 Vac II			
BOXPRES KIT-0.75KW 230Vac	230 Vac II	230 Vac III			
BOXPRES KIT-1.5KW 230Vac	230 Vac II	230 Vac III			
BOXPRES KIT-0.75KW 400Vac	400 Vac III	400 Vac III			
BOXPRES KIT-1.5KW 400Vac	400 Vac III	400 Vac III			
BOXPRES KIT-2.2KW 400Vac	400 Vac III	400 Vac III			
BOXPRES KIT II - 1.5KW 400Vac	400 Vac III	400 Vac III			
BOXPRES KIT II - 2.2KW 400Vac	400 Vac III	400 Vac III			

Dimensions in mm

CJHCH

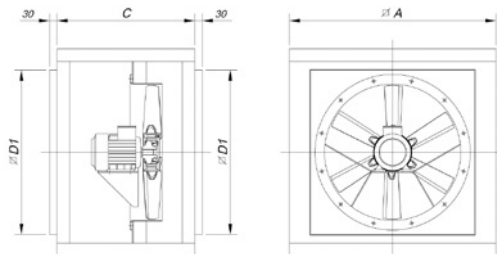

Model	∅A	C	∅D1
CJHCH-40/45/50	700	550	565
CJHCH-56/63	825	550	690

CJBD

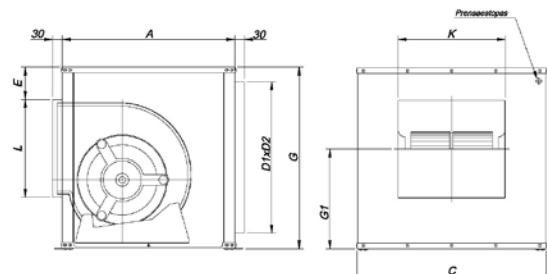

Model	Equiv. inches	A	B	C	E	D1xD2	G1	L	K
CJBD-3333	12/12	650	650	700	92	556X606	379	358	400



EFFICIENT WORK



Dimensions in mm

TWIN

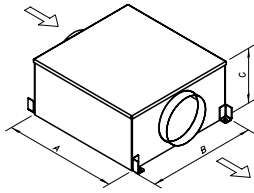

Model	A	B	C
TWIN-12/12	1103	1139	610
TWIN15/15	1279	1639	698

CJHCH/DUPLEX

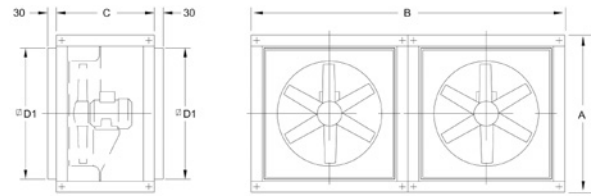

Model	ØA	B	C	ØD1
CJHCH/DUPLEX-56/63	825	1650	550	690

NEOLINEO

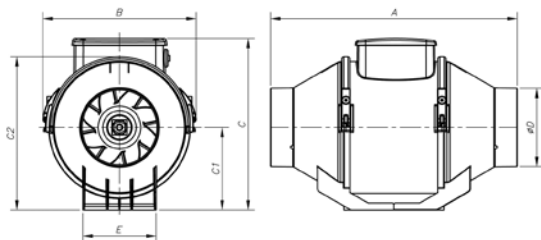

Model	A	B	C	C1	C2	øD	E
NEOLINEO-200	300	234.5	260.5	125.5	235	196	140
NEOLINEO-315	448	361.5	392.5	188.5	359	312	220.5

CJBC

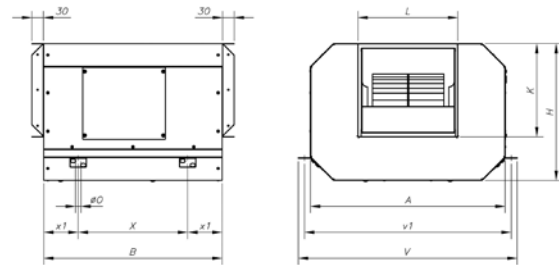

Model	A	B	H	K	L	øO	V	v1	X	x1
CJBC-2828-6M -1/3	696	645	460	290	320	15	755	725	445	100

BOXPRESS KIT SOBREPRESIÓN

Technical characteristics and measurements

Model	Power kW	Power supply (V/Hz)	Output (V/Hz)	Output current (A)	Size	Measurements (L x W x D)
BOXPRES KIT-3A 230Vac	-	230 Vac II	230 Vac II	3	-	255 x 170 x 140 mm
BOXPRES KIT-10A 230Vac	-	230 Vac II	230 Vac II	10	-	255 x 170 x 140 mm
BOXPRES KIT-0,75kW 230Vac	0.75	230 V II / 50Hz	230 V III / 50Hz	4.3	1	270 x 270 x 170 mm
BOXPRES KIT-1,5kW 230Vac	1.5	230 V II / 50Hz	230 V III / 50Hz	7	1	270 x 270 x 170 mm
BOXPRES KIT-0,75KW 400Vac	0.75	400 V III / 50Hz	400 V III / 50Hz	2.2	1	270 x 270 x 170 mm
BOXPRES KIT-1,5KW 400Vac	1.5	400 V III / 50Hz	400 V III / 50Hz	4.1	1	270 x 270 x 170 mm
BOXPRES KIT-2,2KW 400Vac	2.2	400 V III / 50Hz	400 V III / 50Hz	5.8	2	360 x 360 x 205 mm

BOXPRES KIT-3A / KIT-10A

Connection of power and motor

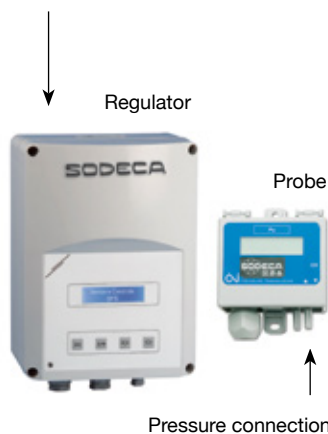

Stuffing-box for cable input to equipment Size 1

M 20 x 1.5mm
Connection of power and motor

M 12 x 1.5mm
Fire signal connection

Pressure connection



Stuffing-box for cable input to equipment Size 2

M 20 x 1.5mm
Connection of power and motor

M 12 x 1.5mm
Fire signal connection

Pressure connection



BOXPRESS KIT SOBREPRESIÓN II

For equipment with reserve fan.

Technical characteristics and measurements

Model	Power kW	Power supply (V/Hz)	Output (V/Hz)	Output current (A)	Size	Measurements (L x W x D)
BOXPRES KIT II - 1.5KW 400Vac	1.5	400 V III / 50Hz	400 V III / 50Hz	4.1	1	270 x 270 x 170 mm
BOXPRES KIT II - 2.2KW 400Vac	2.2	400 V III / 50Hz	400 V III / 50Hz	5.4	2	360 x 360 x 205 mm

* Both motors never operate simultaneously

**Stuffing-box for cable input to equipment
Size 1**

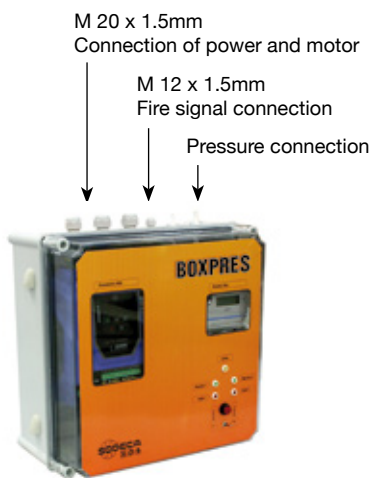

**Stuffing-box for cable input to equipment
Size 2**

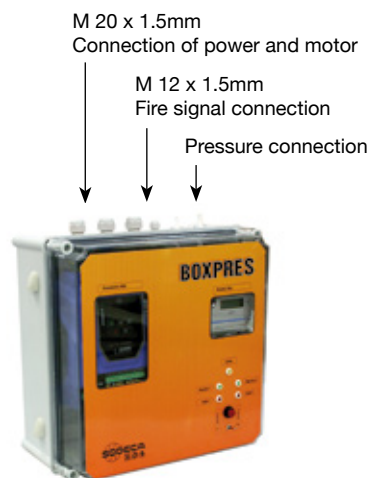
Example of use

Overpressure smoke control method; this system consists of pressurization by means of the injection of air in spaces which are used as escape routes for people in case of fire, such as stair wells, passageways, corridors, elevators, etc. Above all in densely occupied tall buildings. This method is based on smoke control by means of the speed of air and the artificial barrier which is created by excess air pressure over smoke, so that it cannot enter escape routes.

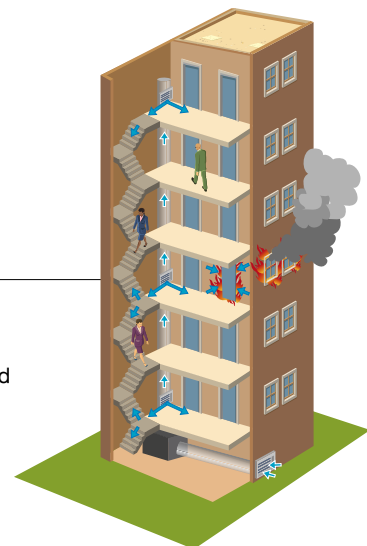



EFFICIENT WORK



ACCESSORIES

Variable speed drive

VSD1/B VSD3/B



Variable speed drive for Brushless motor

102

VSD1/A-RFM VSD3/A-RFT



Variable speed drive for AC motors

102

Control units and sensors

MTP010



Brushless motor speed control 0-10V

103

SI-CO2



Air quality detector

103

SI-TEMP +HUMEDAD



Temperature and relative humidity sensor with display

103

SI-FUENTE DE ALIMENTACIÓN



Power supply 24V dc / ac

103

SI-PIR



Motion detector

103

SI-SMOKE



Tobacco smoke detector

103

SI-TEMP



Temperature sensor

104

SI-PRESIÓN



Pressure transmitter

104

SI-TIMER



Timer

104

CONSTANT FLOW KIT



A set made up of a pressure transmitter and frequency converter

104

SI CONTROL PRESIÓN



Pressure control built-in probe

104

SI-HUMEDAD



Relative humidity sensor

104

BOXPRES KIT BOXPRES KIT/B



105

In-line



DUO



Input and output kits



Rectangular grilles



SV-series protection grilles



NEOLINEO-series protection grilles



Outlet



Capture openings



Inlet/Outlet



Backdraught shutters



Circular grilles



Electric batteries



Butterfly valves



One-way hatches

117



Air filter boxes



C.J.FILTER/CL



Standard installation duct



Standard installation base



Simultaneous installation kit



SR



ARE



PSA



RR



TAC/CL



STUB



















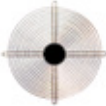









S

Accessories

117



ACCESSORIES

<p>INT</p>  <p>On/Off safety switches in accordance with Standard UNE-EN 60204-1.</p> <p>108</p>	<p>AET</p>  <p>Electrical starter panel star / triangle and protection of fans with three-phase motor</p> <p>108</p>	<p>PL</p>  <p>Backdraught shutters</p> <p>108</p>	<p>P</p>  <p>Aluminium backdraught louvres</p> <p>108</p>	<p>R</p>  <p>Protection guard for aspiration of axial fans.</p> <p>108</p>
<p>RI</p>  <p>Protection guard for outlet of axial fans.</p> <p>109</p>	<p>RT</p>  <p>Protection guard for inlet or outlet of long-cased axial fans.</p> <p>109</p>	<p>RPA</p>  <p>Protection guard for inlet of centrifugal fans.</p> <p>109</p>	<p>PV</p>  <p>Inlet hood with guard</p> <p>109</p>	<p>BTUB</p>  <p>Coupling flange for axial fans.</p> <p>110</p>
<p>B</p>  <p>Coupling flange for centrifugal fans.</p> <p>110</p>	<p>BD</p>  <p>Dual coupling flange for centrifugal fans</p> <p>110</p>	<p>BAC</p>  <p>Double, elastic coupling flange for axial fans</p> <p>111</p>	<p>PS</p>  <p>Support stands for long-cased fans.</p> <p>111</p>	<p>PSB</p>  <p>Set of support stand for low-pressure centrifugal fans</p> <p>111</p>
<p>MS</p>  <p>Support frame to facilitate mounting on-site.</p> <p>111</p>	<p>TEJ</p>  <p>Outside covers.</p> <p>111</p>	<p>VIS</p>  <p>Outlet hood with protection guard.</p> <p>112</p>	<p>PA</p>  <p>Adaptation plate to mount accessories on roof fans.</p> <p>112</p>	<p>BS BSS</p>  <p>High base plate and high base plate with silencer</p> <p>112</p>
<p>PT PT/H</p>  <p>Automatic-closing shutters to work in vertical or horizontal position</p> <p>113</p>	<p>BIC</p>  <p>Flange to change from rectangular to circular for centrifugal fans.</p> <p>113</p>	<p>ACE</p>  <p>Elastic coupling to absorb vibrations</p> <p>114</p>	<p>REG</p>  <p>Record of regulation manual</p> <p>114</p>	<p>CJACUS</p>  <p>Soundproofed boxes for centrifugal fans</p> <p>114</p>
<p>OP</p>  <p>Backdraught shutters for roof fans</p> <p>114</p>	<p>S</p>  <p>Silencers to fit to inlet or outlet</p> <p>115</p>			



EFFICIENT WORK



Variable speed drive



VSD1/B VSD3/B

Features:

- Converters for power for Industrial Brushless synchronous motors and variable reluctance synchronous motors.
- Converter supply:
 - Single-phase (VSD1/B): 220-240V 50/60 Hz
 - Three-phase (VSD3/B): 380-400V 50/60 Hz
- In accordance with Electromagnetic Compatibility Directives 92/31/EEC and 93/68/EEC and in accordance with Low Voltage Directive 73/23/EEC
- On/Off input to enable/disable the variable speed drive.
- 0-10V input for speed control.
- Connection available to ModBus RTU bus.

Variable speed drive for Brushless motor

VSD1/B

Model	VSD1/B-0,37kW	VSD1/B-0,75kW	VSD1/B-1,5kW	VSD1/B-2,2kW
Maximum current (A)	2,3	4,3	7,0	10,5
Power (kW)	0,37	0,75	1,5	2,2
Input				
Input type	Single phase	Single phase	Single phase	Single phase
Voltage (V)	220-240 V	220-240 V	220-240 V	220-240 V
Frequency (Hz)	50-60 Hz	50-60 Hz	50-60 Hz	50-60 Hz
Output				
Output Type	Three phase	Three phase	Three phase	Three phase
Voltage (V)	120-230 V	120-230 V	120-230 V	120-230 V
Frequency (Hz)	0-500 Hz	0-500 Hz	0-500 Hz	0-500 Hz
Refrigeration	Forced	Forced	Forced	Forced

VSD3/B

Model	VSD3/B-0,75kW	VSD3/B-1,5kW	VSD3/B-2,2kW
Maximum current (A)	2,2	4,1	5,8
Power (kW)	0,75	1,5	2,2
Input			
Input type	Three-phase	Three-phase	Three-phase
Voltage (V)	380-480 V	380-480 V	380-480 V
Frequency (Hz)	50-60 Hz	50-60 Hz	50-60 Hz
Output			
Output Type	Three-phase	Three-phase	Three-phase
Voltage (V)	120-480 V	120-480 V	120-480 V
Frequency (Hz)	0-500 Hz	0-500 Hz	0-500 Hz
Refrigeration	Forced	Forced	Forced



VSD1/A-RFM VSD3/A-RFT

Variable speed drive for AC motors

Features:

- Converter for varying the speed, via voltage and frequency, of axial and centrifugal fans with asynchronous three-phase motors
- Converter supply:
 - Single-phase (VSD1/B): 200-240V 50/60 Hz
 - Three-phase (VSD3/B): 380-480V 50/60 Hz
- In accordance with Electromagnetic Compatibility Directives 92/31/EEC and 93/68/EEC and in accordance with Low Voltage Directive 73/23/EEC
- On/Off input to enable/disable the variable speed drive.
- 0-10V input for speed control.
- Connection available to ModBus RTU bus.

VSD1/A-RFM

Model	VSD1/A-RFM-0.5	VSD1/A-RFM-1	VSD1/A-RFM-2	VSD1/A-RFM-3
Power (CV)	0.50	1.00	2.00	3.00
Power (kW)	0.37	0.75	1.50	2.20
Maximum current (A)	2.3	4.3	7.0	10.5
Input				
Input type	Single-phase	Single-phase	Single-phase	Single-phase
Voltage (V)	200-240 V	200-240 V	200-240 V	200-240 V
Frequency (Hz)	50-60 Hz	50-60 Hz	50-60 Hz	50-60 Hz
Output				
Output type	Three-phase	Three-phase	Three-phase	Three-phase
Voltage (V)	200-240 V	200-240 V	200-240 V	200-240 V
Frequency (Hz)	0-500 Hz	0-500 Hz	0-500 Hz	0-500 Hz
Refrigeration	Forced	Forced	Forced	Forced

VSD3/A-RFT

Model	VSD3/A-RFT-1	VSD3/A-RFT-2	VSD3/A-RFT-3	VSD3/A-RFT-5.5	VSD3/A-RFT-7.5	VSD3/A-RFT-10	VSD3/A-RFT-15	VSD3/A-RFT-20	VSD3/A-RFT-25	VSD3/A-RFT-30
Power (CV)	1.00	2.00	3.00	5.50	7.50	10.00	15.00	20.00	25.00	30.00
Power (kW)	0.75	1.50	2.20	4.00	5.50	7.50	11.00	15.00	18.50	22.00
Maximum current (A)	2.2	4.1	5.8	9.5	14.0	18.0	24.0	30.0	39.0	46.0
Input										
Input type	Three-phase	Three-phase	Three-phase	Three-phase	Three-phase	Three-phase	Three-phase	Three-phase	Three-phase	Three-phase
Voltage (V)	380-480 V	380-480 V	380-480 V	380-480 V	380-480 V	380-480 V	380-480 V	380-480 V	380-480 V	380-480 V
Frequency (Hz)	50-60 Hz	50-60 Hz	50-60 Hz	50-60 Hz	50-60 Hz	50-60 Hz	50-60 Hz	50-60 Hz	50-60 Hz	50-60 Hz
Output										
Output type	Three-phase	Three-phase	Three-phase	Three-phase	Three-phase	Three-phase	Three-phase	Three-phase	Three-phase	Three-phase
Voltage (V)	380-480 V	380-480 V	380-480 V	380-480 V	380-480 V	380-480 V	380-480 V	380-480 V	380-480 V	380-480 V
Frequency (Hz)	0-500 Hz	0-500 Hz	0-500 Hz	0-500 Hz	0-500 Hz	0-500 Hz	0-500 Hz	0-500 Hz	0-500 Hz	0-500 Hz
Refrigeration	Forced	Forced	Forced	Forced	Forced	Forced	Forced	Forced	Forced	Forced



Control units and sensors



MTP010

10KΩ potentiometer to control the speed

- Potentiometer to control the speed of fans equipped with a brushless or asynchronous motor with VSD
- Progressively delivers a voltage of between 0 and 10V DC.
- Can be used as a switch.
- Moisture-resistant body.
- Can be surface-mounted or built-in.



SI-CO2

Air quality detector

Automatically activates the ventilation system when the increase in contamination, as a function of the occupation of the premises, exceeds the pre-set value

Model	Power supply	Output	Consumption (W)	Adjustments	Height installation	Working temperature
SI-CO2-GAQ24	24V ac	0-10V	5	Timing 10s-30 min	1.5-2.5 m	-20°C +50°C



SI-TEMP+HUMEDAD

Option: Optional duct probes for temperature and humidity

Temperature and relative humidity sensor with display

Independently controls the temperature and the relative humidity of the air on the premises. Automatically activates the ventilation system when it detects a temperature or humidity greater than the pre-set value. Once the environmental temperature or humidity has descended below the pre-set point, the fan remains functioning for a pre-set period, which can be adjusted by means of the internal clock.

Model	Power supply	Output	Adjustments	Height installation	Working temperature
SI-TEMP+HUMEDAD	24V ac	0-10V dc	$\Delta T = 0.5^{\circ}\text{C}$ and $\Delta \text{HR} = 2\%$	1.5-2.5 m	+10°C +40°C



SI-FUENTE DE ALIMENTACIÓN

Power supply 24V dc / ac

Powers the intelligent 24V dc/ac sensors from an input voltage of 230V. single-phase.

Model	Power supply	Output	Installed (VA)
SI-FUENTE DE ALIMENTACIÓN dc	230 V	24V dc	30
SI-FUENTE DE ALIMENTACIÓN ac	230/400 V	24/48V ac	25



SI-PIR-TF-Cenital



SI-PIR-TF-Mural

SI-PIR

Motion detector

Automatically activates the ventilation system when it detects the presence of people within its radius of action and keeps functioning for a pre-set time, which can be adjusted by means of an internal clock

Model	Power supply	Output	Detection angle	Adjustments	Height installation	Working temperature
SI-PIR	230V	230V	360°C	Timing 5s-30 min	2.4-4.2 m	-20°C +50°C
SI-PIR-TFT-550-B	24V ac/24V dc	24V ac/24V dc	110°C	Timing 5s-30 min	1.8-3.6 m	-20°C +50°C
SI-PIR-TF-25-360	24V ac/24V dc	24V ac/24V dc	360°C	Timing 10s-30 min	2.4-4.2 m	-20°C +50°C

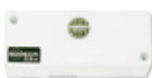

SI-SMOKE

Tobacco smoke detector

Automatically activates the ventilation system when tobacco smoke and other contaminants exceed the pre-set value in the sensor and keeps functioning for a pre-set time, which can be adjusted by means of an internal clock

Model	Power supply	Output	Maximum current (A)	Adjustments	Height installation	Working temperature
SI-SMOKE	220-240V ac	220-240V ac	3.0	Timing 3min-20 min	1.5-2.0 m	-20°C +50°C



EFFICIENT WORK



SI-TEMP

Temperature sensor

Automatically activates the ventilation system when it detects a temperature greater than the pre-set value. Once the environmental temperature has descended below the pre-set point, the fan remains functioning for a pre-set period, which can be adjusted by means of the internal clock. The range of temperature oscillates between +10°C and 40°C

Model	Power supply	Output	Maximum current (A)	Adjustments	Height installation	Working temperature
SI-TEMP	220-240V ac	220-240V ac	3.0	Timing 3min-20 min	1.5-2.0 m	+10°C +40°C



SI-PRESIÓN

Pressure transmitter

Controls the pressure in installations with constant pressure ventilation, and transforms it into an electrical signal to regulate the ventilation system and constantly maintain the same pressure.

Model	Power supply	Output	Maximum consumption (VA)	Ø Connectors	Pressure range
SI-PRESIÓN TPDA	24V ac/24V dc	0-10V/4-20mA	4	6.2 mm	0-2500 Pa
SI-PRESIÓN TPDA c/DISPLAY	24V ac/24V dc	0-10V/4-20mA	4	6.2 mm	0-2500 Pa



SI-TIMER

Timer

Adjusts the operating time of the ventilation system to which it is connected. The ventilation system is automatically activated when the light switch goes on and continues to function for a pre-set time which can be altered by means of the internal clock

Model	Power supply	Output	Maximum current (A)	Adjustments	Working temperature
SI-TIMER	220-240V ac	220-240V dc	3.0	Timing 3min-20 min	-20°C +50°C



+



CONSTANT FLOW KIT

A set made up of a pressure transmitter and frequency converter, designed to increase the speed of the fan as the filter gets dirtier, and to maintain a constant flow in the installation.



SI CONTROL PRESIÓN

Pressure control built-in probe

Pressure control built-in probe Can control a variable speed drive or EC motor in order to maintain the desired pressure, using a pressure probe built into the equipment. The equipment runs off 230 VAC power and send 0-10V control signals.



SI-HUMEDAD

Relative humidity sensor

Relative humidity sensor to be installed on a wall.

Model	Power supply	Output	Range use
SI-HUMEDAD	24 V AC	0-10V/4-20mA	-10°C...50°C



CENTRAL CO

Monoxide detection centres for control of ventilation in car parks

In order to fulfil Royal Decree 2367/1985 and the Technical Building Code

The Carbon Monoxide detection centres have been designed for application in underground car parks, tunnels or other locations where dangerous concentrations of CO might accumulate.

The system consists of the installation of a centre of 1 to 3 modules of areas with indicator display and each module permits connection of up to 32 detectors connected with two wires, with a maximum distance to the final detector of 2 kilometres

The detectors may be distributed over 2000 metres in length and each detector covers a maximum of 200m² of area as is defined in the current regulations

Through the optional FM-TC500 card it is possible to control a series RFM or RFT speed regulator, with the aim of reducing the energy consumption and the acoustic level of the extractors.

These systems involve a significant energy saving.

- System certified according to standard 23300/84
- Certification LOM 09MOGA3054.
- Modular and extensible centre
- Up to 19000 m² of management
- Versions of 1, 2, and 3 modules of areas
- Indication of the concentration per area
- 2 outlets of relays of extraction per area.
- 1 outlet of relay of alarm per area.

- Up to 32 detectors per area.
- Connection of the detectors to 2 wires.
- Mode of operation for low consumption.
- Option of Control by Speed Varier to reduce energy consumption and the sound level.
- Option of remote control of the system and integration with systems of energy analysis.

Model	Application
FMC-C-501	Centre for 1 areas
FMC-C-502	Centre for 2 areas
FMC-C-503	Centre for 3 areas
FM-M-509	Module for extension of area
FM-DP500	CO wall detector
FM-D500	CO ceiling detector
FM-TC500	Control card per varier

CENTRES: Series FMC-C-501/502/503

- For 1, 2 or 3 areas depending on model
- Supplied voltage: 90 ~264VAC
- Power: 45 W
- Zone extension module FM-M-509
- Wiring of the area: 2 wires
- Maximum distance from the area line: 2 km. with 1.5 mm² cable
- No. detectors per area: 32 detectors

CO Detector: Series FM-DP500/FM-D500

- Wall or ceiling mounted CO Detector according to model
- Technology: Electrochemical cell
- Useable lifetime: 5 years
- Resolution: 1 ppm
- Reaction time: 10 seconds
- Storage temperature: -10°C to + 80°C
- Working area: 200m² limited by regulation
- IP Index from FM-D500: IP20
- IP Index from FM-DP500: IP54

Control card per varier. Series FM-TC500

- Module with PWM outlets which makes it possible to attack the extraction motors by means of speed regulators (energy saving).
- Communications module to carry out actions of tele-maintenance and tele-management.
- Open communications protocol for integration with other systems.



BOXPRES KIT BOXPRES KIT/B

- The proper operation of the pressurisation systems depends not only on correct design but also on the proper regulation carried out by the system with the result that it is of vital importance to have calibrated and highly-precise regulation elements which make it possible to have the two situations in the case of fire, in a rapid and stable manner.
- The BOXPRES control panel, apart from satisfying the most demanding requirements, simplifies the work of the installer to the greatest possible extent.
- Includes:
 - Frequency varier programmed to 50 Pa
 - Differential pressure probe
 - Magneto thermal
 - Line LED and fault
 - Check button
- BOXPRES is a piece of equipment with all its interconnections made and tested
 - Ready to work and carry out its duties on the pressure control of the installation.
 - Possibility of checking the installation so as to prevent faults.
 - Only the power cable, the impulsion fan and the fire signal should be connected.

Boxpres Overpressure kit for asynchronous three-phase motor.

Model	Include varier	Power kW	Power supply (V/Hz)	Output (V/Hz)	Output current (A)	Size	Measurements (L x W x D)
BOXPRES KIT-0.37kW 230Vac	VSD1/A-RFM-0.5	0.37	230 V II / 50Hz	230 V III / 50Hz	2.2	1	270 x 270 x 170 mm
BOXPRES KIT-0.75kW 230Vac	VSD1/A-RFM-1	0.75	230 V II / 50Hz	230 V III / 50Hz	4.3	1	270 x 270 x 170 mm
BOXPRES KIT-1.5kW 230Vac	VSD1/A-RFM-2	1.50	230 V II / 50Hz	230 V III / 50Hz	7.0	1	270 x 270 x 170 mm
BOXPRES KIT-2.2kW 230Vac	VSD1/A-RFM-3	2.20	230 V II / 50Hz	230 V III / 50Hz	10.5	2	360 x 360 x 205 mm
BOXPRES KIT-0.75KW 400Vac	VSD3/A-RFT-1	0.75	400 V III / 50Hz	400 V III / 50Hz	2.2	1	270 x 270 x 170 mm
BOXPRES KIT-1.5KW 400Vac	VSD3/A-RFT-2	1.50	400 V III / 50Hz	400 V III / 50Hz	4.1	1	270 x 270 x 170 mm
BOXPRES KIT-2.2KW 400Vac	VSD3/A-RFT-3	2.20	400 V III / 50Hz	400 V III / 50Hz	5.8	2	360 x 360 x 205 mm

Boxpres Overpressure kit for Industrial Brushless Motors E.C.

Model	Include varier	Power kW	Power supply (V/Hz)	Output (V/Hz)	Output current (A)	Size	Measurements (L x W x D)
BOXPRES KIT/B-0.37kW 230Vac	VSD1/B-0.37	0.37	230 V II / 50Hz	230 V III / 50Hz	2.2	1	270 x 270 x 170 mm
BOXPRES KIT/B-0.75kW 230Vac	VSD1/B-0.75	0.75	230 V II / 50Hz	230 V III / 50Hz	4.3	1	270 x 270 x 170 mm
BOXPRES KIT/B-1.5kW 230Vac	VSD1/B-1.5	1.50	230 V II / 50Hz	230 V III / 50Hz	7.0	1	270 x 270 x 170 mm
BOXPRES KIT/B-2.2kW 230Vac	VSD1/B-2.2	2.20	230 V II / 50Hz	230 V III / 50Hz	10.5	2	360 x 360 x 205 mm
BOXPRES KIT/B-0.75KW 400Vac	VSD3/B-0.75	0.75	400 V III / 50Hz	400 V III / 50Hz	2.2	1	270 x 270 x 170 mm
BOXPRES KIT/B-1.5KW 400Vac	VSD3/B-1.5	1.50	400 V III / 50Hz	400 V III / 50Hz	4.1	1	270 x 270 x 170 mm
BOXPRES KIT/B-2.2KW 400Vac	VSD3/B-2.2	2.20	400 V III / 50Hz	400 V III / 50Hz	5.8	2	360 x 360 x 205 mm

**Stuffing-box for cable input to equipment
Size 1**

M 20 x 1.5mm
Connection of power and motor
M 12 x 1.5mm
Fire signal connection
Pressure connection

**Stuffing-box for cable input to equipment
Size 2**

M 20 x 1.5mm
Connection of power and motor
M 12 x 1.5mm
Fire signal connection
Pressure connection





EFFICIENT WORK



Electronic speed controllers



For single-phase fans, possibility of installing on a surface or built-in

Model	Input voltage	Protection	Max. current (A)
RM-00	230 V -50/60 Hz	IP-44	0.5
RM-01	230 V -50/60 Hz	IP-44	1
RM-02	230 V -50/60 Hz	IP-44	2

DUO



Speed-change and stop switch, for small fans with two-speed motor

Model	Input voltage	Max. current (A)
DUO	230 V -50/60 Hz	16

Brushless motor speed control



Model	Output voltage	Resistance value
MTP	0-10VDC	10KΩ

Capture openings



Made from plastic to open onto duct

Model	Ext. measurements	Duct
BC-135x235	135x235mm	100mm
BC-140x340	140x340mm	100mm
BC-240x240	240x240mm	150mm

Outlet



Made from plastic to install on the exterior

Model	External measurements
SA-140x140	140x140mm
SA-240x240	240x240mm

Inlet/Outlet



Made from plastic with diffuser

Model	For duct	Colour
BA-100/B	100mm	White
BI-100/B	100mm	White

Input and output kits



Formed by 2 grilles and a flexible tube

Model	Duct	Air flow
KIT-120	120mm	100cm ²
KIT-160	160mm	100cm ²
KIT-200	200mm	100cm ²

Rectangular grilles



Made from plastic to adapt to rectangular hole

Model	Ext. measurements	For hole with
R-140 x 140	140 x 140 mm	102 x 102 mm
R-189 x 189	189 x 189 mm	150 x 150 mm
R-240 x 140	240 x 140 mm	202 x 102 mm
R-340 x 140	340 x 140 mm	308 x 108 mm

Circular grilles



Made from plastic with universal spring system to adapt to circular hole

Model	Ext. measurements	For hole with
RC-100/B	106 mm	40 to 80 mm
RC-125/B	155 mm	80 to 125 mm
RC-150/B	175 mm	125 to 160 mm
RC-200/B	235 mm	165 to 220 mm
RC-250/B	270 mm	220 to 260 mm

NEOLINEO-series protection grilles



Protects against contact with the impeller and objects from entering

Model	Applies to models	Model	Applies to models
G 100	NEOLINEO-100	G 200	NEOLINEO-200
G 125	NEOLINEO-125	G 250	NEOLINEO-250
G 150	NEOLINEO-150	G 315	NEOLINEO-315
G 160	NEOLINEO-160		

Backdraught shutters



Made from plastic that is adapted directly to the wall on which the fan is mounted

Model	External measurements
PL-140x140	140x140mm
PL-180x180	180x180mm
PL-240x240	240x240mm
PL-340x340	340x340mm
PL-440x440	440x440mm

SV-series protection grilles



Protects against contact with the impeller and objects from entering

Model	Applies to models
RAI-125	SV-125
RAI-150	SV-150
RAI-200	SV-200
RAI-250	SV-250
RAI-315	SV-315
RAI-350	SV-350
RAI-400	SV-400

Standard installation base



NEOLINEO adaptation plate between two fans

Model	Applies to models
SF 500	NEOLINEO-100,125,150,160,200
SF 700	NEOLINEO-250,315

Simultaneous installation kit



Set of parts for simultaneous installation of two NEOLINEO fans

Model	Applies to models	Model	Applies to models
PF100	NEOLINEO-100	PF160	NEOLINEO-160
PF125	NEOLINEO-125	PF200	NEOLINEO-200
PF150	NEOLINEO-150	PF250	NEOLINEO-250

Standard installation duct



NEOLINEO pipe connecting two fans

Model	Applies to models	Model	Applies to models
C100	NEOLINEO-100	C200	NEOLINEO-200
C125	NEOLINEO-125	C250	NEOLINEO-250
C150	NEOLINEO-150	C315	NEOLINEO-315
C160	NEOLINEO-160		

Accessories



Easy to install for mounting in localised inlet systems

Model	Features:
TUB-100	Duct with diameter of 100 mm and length of 1 m
UN-100	Joint between duct and accessories
COD-100	90° elbow with diameter of 100 mm
BRIDA-100	Duct fastening clamps
REDU-100-125	Reduction of pipe to different diameters
TUB-125	Duct with diameter of 125 mm and length of 1 m
UN-125	Joint between duct and accessories
COD-125	90° elbow with diameter of 125 mm
BRIDA-125	Duct fastening clamps
REDU-125-100	Reduction of pipe to different diameters

One-way hatches



To fit in circular ducts

Model	Applies to models	Model	Applies to models
S 100	NEOLINEO-100	S 200	NEOLINEO-200
S 125	NEOLINEO-125	S 250	NEOLINEO-250
S 150	NEOLINEO-150	S 315	NEOLINEO-315
S 160	NEOLINEO-160		

Air filter boxes



Rectangular filter boxes for circular ducts, fitted with G3-G4 filters

Model	G3-G4 filter box for the following duct
AIRFILTER-100-G3/G4	100mm
AIRFILTER-125-G3/G4	125mm
AIRFILTER-160-G3/G4	160mm
AIRFILTER-200-G3/G4	200mm
AIRFILTER-250-G3/G4	250mm
AIRFILTER-315-G3/G4	315mm
AIRFILTER-355-G3/G4	355mm
AIRFILTER-400-G3/G4	400mm

Electric batteries



Adapted to the outlet

Model	Electrical battery for the following duct
BE-100	100 mm, 0.4 kW 230 V
BE-125	125 mm, 1.2 kW 230 V
BE-160	160 mm, 2.4 kW 230 V
BE-200	200 mm, 5 kW 400 V
BE-250	250 mm, 6 kW 400 V
BE-315	315 mm, 7.5 kW 400 V
BE-355	355 mm, 9 kW 400 V
BE-400	400 mm, 9 kW 400 V

Butterfly valves



To fit in circular ducts

Model	Butterfly valves for	Model	Butterfly valves for
V-100	100mm	V-250	250mm
V-125	125mm	V-315	315mm
V-160	160mm	V-355	355mm
V-200	200mm	V-400	400mm

STUB



Model	Applies to models
STUB-200	TUB
STUB-225	TUB
STUB-250	TUB

ARE

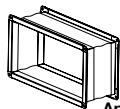

Elastic rectangular connection

Model	Applies to models	Model	Applies to models
ARE-200	CL-200	ARE-315	CL-315
ARE-225	CL-225	ARE-355	CL-355
ARE-250	CL-250	ARE-400	CL-400
ARE-280	CL-280	ARE-450	CL-450

RR

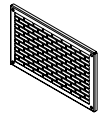

Protection grille for inlet or outlet

Model	Applies to models	Model	Applies to models
RR-200	CL-200	RR-315	CL-315
RR-225	CL-225	RR-355	CL-355
RR-250	CL-250	RR-400	CL-400
RR-280	CL-280	RR-450	CL-450

CJFILTER/CL

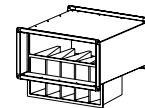

Rectangular air filter boxes

Model	Applies to models	Model	Applies to models
CJFILTER/CL-200	CL-200	CJFILTER/CL-315	CL-315
CJFILTER/CL-225	CL-225	CJFILTER/CL-355	CL-355
CJFILTER/CL-250	CL-250	CJFILTER/CL-400	CL-400
CJFILTER/CL-280	CL-280	CJFILTER/CL-450	CL-450

SR



Rectangular silencers

Model	Applies to models	Model	Applies to models
SR-200	CL-200	SR-315	CL-315
SR-225	CL-225	SR-355	CL-355
SR-250	CL-250	SR-400	CL-400
SR-280	CL-280	SR-450	CL-450

TAC/CL

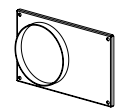

Circular coupling plate.

Model	Applies to models	Model	Applies to models
TAC/CL-200	CL-200	TAC/CL-315	CL-315
TAC/CL-225	CL-225	TAC/CL-355	CL-355
TAC/CL-250	CL-250	TAC/CL-400	CL-400
TAC/CL-280	CL-280	TAC/CL-450	CL-450

PSA

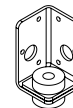

Ceiling base

Model	Applies to models
PSA-200	CL-200, CL-225, CL-250, CL-280, CL-315, CL-355, CL-400, CL-450

SC



Silencers to fit to inlet or outlet

Features:

- Circular silencers to fit to inlet or outlet on in-line fans
- Silencers fitted with a neck to attach circular ducts.

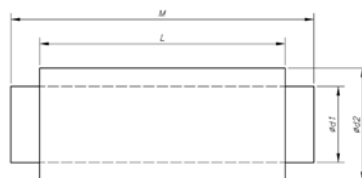

Model	Ød1	ød2	L	M	Acoustic noise reduction							
					63	125	250	500	1000	2000	4000	8000
S-125	125	225	600	720	1.1	2.9	8.8	19.4	27.2	34.1	27.2	13.4
S-160	160	260	600	720	1	2.9	7.2	16.5	23.4	29.6	20.3	9.2
S-200	200	300	600	720	0.95	2.9	7	14.6	20.3	25.8	15.6	6.8
S-250	250	355	600	720	0.22	2.1	7.2	12.5	18.8	23	10.3	5.15
S-315	315	415	600	720	0.2	2.1	7.2	10.3	15	20	7	3.9
S-355	355	450	700	820	3.6	4.2	6.5	13.2	14.2	4	7.9	7.2



EFFICIENT WORK



INT Stop-start safety switches in accordance with Standard UNE-EN 60204-1.

Features:

- Switch to be placed beside the fan, so that mains current can be cut without handling the fan
- IP65 protection
- For three-phase or two-speed fans, use 6-pole switch
- For single-phase fans, use a 3-pole switch

Model	Current (A)	(kW)	Cables input (mm)	Model	Current (A)	(kW)	Cables input (mm)
INT-CA 10/3CA	20	5.5	19	INT-CA 10/6CA	20	5.5	19
INT-KG 10/3CA	20	5.5	23	INT-KG 10/6CA	20	5.5	23
INT-KG 20/3CA	25	7.5	29	INT-KG 20/6CA	25	7.5	29
INT-KG 32/3CA	32	11	29	INT-KG 32/6CA	32	11	29
INT-KG 41/3CA	40	15	37.5	INT-KG 41/6CA	40	15	37.5
INT-KG 64/3CA	63	22	37.5	INT-KG 64/6CA	63	22	37.5
INT-KG 80/3CA	80	30	37.5	INT-KG 80/6CA	80	30	37.5
INT-KG 100/3CA	100	37	37.5	INT-KG 100/6CA	100	37	37.5



AET

Electrical starter panel, star / triangle, and protection of fans with three-phase motor, with On/Off buttons

Features:

- On/Off by button
- Display of condition by means of luminous pilot lights
- Incorporates adjustable thermal relay for protection of the motor
- Fully cabled
- Metal plate for assembly on the surface, IP-65 protection

For fan with three-phase motor 230V/400V
Power supply 3x230V

Model	Current regulation of thermal relay (A)	Power motor of 3x230/400V (kW)
AET-01-3/230	4-6.3	2.2
AET-01-4/230	5-8	3.0
AET-01-5.5/230	7-10	4.0
AET-01-7.5/230	12-18	5.5
AET-01-10/230	12-18	7.5
AET-01-15/230	18-26	11.0
AET-01-20/230	24-36	15.0
AET-01-25/230	28-40	18.5
AET-02-30/230	34-50	22.0
AET-02-40/230	45-65	30.0
AET-02-50/230	63-85	37.0

For fan with three-phase motor 400V/690V.
Power supply 3x400V+N

Model	Current regulation of thermal relay (A)	Power motor of 3x400/690V (kW)
AET-01-5.5/400	4-6.3	4
AET-01-7.5/400	5-8	5.5
AET-01-10/400	7-10	7.5
AET-01-15/400	12-18	11
AET-01-20/400	12-18	15
AET-02-30/400	18-26	18.5/22.0
AET-02-40/400	28-40	30
AET-02-50/400	34-50	37
AET-02-60/400	45-65	45
AET-02-75/400	45-65	55



PL Plastic backdraught louvres

Features:

- The backdraught louver is adapted directly to the wall where the fan is mounted.
- Opening through excess pressure due to airflow
- Closed when the fan is on standby
- Made from plastic
- Maximum recommended speed 12m/sec for models 80, 80,90 and 100

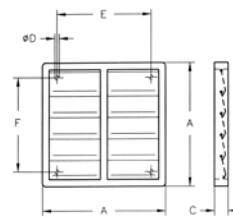

Model Measurements

Model	A	C	ØD	E	F
PL-20	240	28	5.2	193	167
PL-25	294	26	5	232	232
PL-31	347	26	5	276	276
PL-35	397	26	5	310	310
PL-40	459	26	5	364	364
PL-45	501	26	5	395	395
PL-50	549	31	5	445	445
PL-56	605	28	5	522	522
PL-63	696	31	5	626	626
PL-71	760	40	5	692	692
PL-80	840	40	5	772	772
PL-90	940	40	5	872	87
PL-100	1040	40	5	972	972



P Aluminium backdraught louvres

Features:

- The backdraught louver is adapted directly to the wall where the fan is mounted.
- Opening through excess pressure due to airflow
- Closed when the fan is on standby
- Aluminium sheet construction
- Maximum recommended speed 18m/sec for models 80, 90 and 100

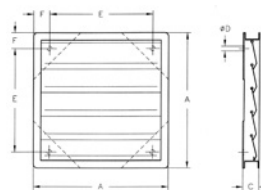

Model Measurements

Model	A	C	ØD	E	F
P-25	290	51	6	187	51.5
P-35	400	81	6	266	67
P-45	500	51	6	347	76.5
P-56	600	51	6	447	76.5
P-63	715	72	6	535	90
P-71	780	72	6	605	87.5
P-80	875	72	6	675	100
P-90	970	72	6	755	107.5
P-100	1070	72	6	850	110



R Protection guard for aspiration of axial fans.

Model	HC	HCH
R-35/B	-	35
R-40	-	40
R-45	-	45
R-56	-	56-4T/M-0.75, 56-4T-1, 56-6T/M-0.33, 56-6T-0.5, 56-6T-0.75
R-56 - 1,5	-	56-4T-1.5, 56-4T-2
R-63 - 0,5	-	63-4T-1, 63-6T/M-0.5, 63-6T-0.75
R-63 - 1,5	-	63-4T-1.5, 63-4T-2, 63-6T-1
R-63 - 4	-	63-4T-3, 63-4T-4
R-71	-	71-4T-1.5, 71-4T-2, 71-6T/M-0.75, 71-6T-1, 71-6T-1.5
R-71/C	71	
R-71-3	-	71-4T-3, 71-4T-4
R-80	-	80-6T-1, 80-6T-1.5, 80-8T-0.5, 80-8T-0.75

Model	HC	HCH
R-80/C	80	
R-80 - 5,5	-	80-4T-3, 80-4T-4, 80-4T-5.5, 80-6T-2, 80-6T-3, 80-8T-1
R-90	-	90-4T-4, 90-4T-5.5, 90-6T-2, 90-6T-3, 90-8T-1, 90-8T-1.5, 90-8T-2
R-90/C	90	
R-90 - 7,5	-	90-4T-7.5, 90-4T-10, 90-6T-4, 90-8T-3
R-100	-	100-6T-3, 100-8T-1.5, 100-8T-2
R-100/C	100	
R-100-7,5/C	100 4T/H	
R-100 - 10	-	100-4T-7.5, 100-4T-10, 100-6T-4, 100-6T-5.5, 100-8T-1.5, 100-8T-2
R-100 - 20	-	100-4T-15, 100-4T-20



RI Protection guard for outlet of axial fans.

Model	HEP	HCD	HC	HRE	HCH
RI-20	-	20	-	-	-
RI-25/E	-	-	-	25	-
RI-25	25	25	25	-	-
RI-31/E	-	-	-	31	-
RI-31	31	30	31	-	-
RI-35/E	-	-	-	35	-
RI-35/B	-	-	-	-	35
RI-35/C	35	35	35	-	-
RI-40	40	40	40	-	40

Model	HEP	HCD	HC	HRE	HCH
RI-45	45	-	45	-	45
RI-50	50	-	50	-	-
RI-56	56	-	56	-	56
RI-63	63	-	63	-	63
RI-71	-	-	71	-	71
RI-80	-	-	80	-	80
RI-90	-	-	90	-	90
RI-100	-	-	100	-	100

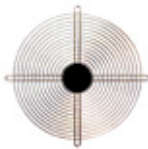

RT Protection guard for inlet or outlet of long-cased axial fans.

Model	HEPT	HCT	HGT	HPX
RT-25	-	25	-	-
RT-31/B	-	31	-	-
RT-31	31	-	-	-
RT-35	35	35	-	35
RT-40	40	40	-	-

Model	HEPT	HCT	HGT	HPX
RT-45	45	45	-	45
RT-50	50	50	-	50
RT-56	56	56	-	56
RT-63	63	63	-	63
RT-71	-	71	-	71

Model	HEPT	HCT	HGT	HPX
RT-80	-	80	-	80
RT-90	-	90	-	90
RT-100	-	100	-	100
RT-125	-	-	125	-
RT-125/CC	-	-	125	-



RPA Protection guard for inlet of centrifugal fans.

Features:

- Protects against contact with the impeller and prevents objects from entering, in accordance with standard UNE-100250
- Made from sheet steel.

Applies to models

Model	CMA CMAT	CMC	CB	CBP	CAS	CA	CAM	CMP	CMT	CMR-X CMR
RPA-10	-	-	-	-	-	-	-	38	-	-
RPA-11	218	-	-	-	-	-	-	-	-	-
RPA-13	324	-	-	-	-	234	-	-	-	-
RPA-15	325/426	-	-	-	242	142	-	512	-	-
RPA-17	527	-	-	-	248	148	-	514	-	-
RPA-18	528	-	-	-	254	154	-	-	-	-
RPA-20	531	-	-	-	260	-	-	616	-	-
RPA-23	-	628/630	-	-	680 160/166/172	-	540/545	718	922	-
RPA-25	540/545	835/840	820	-	790	-	-	620/820	1025	-
RPA-28	-	-	-	-	463/467	-	550/752	922	1128	-
RPA-31	-	-	1428	-	-571/640/645/650/980/1080-	-	760	1025	1231	-
RPA-35	-	-	-	-	-852/990/1090	-	-	1128	1435/1640	-
RPA-38	-	-	1733	-	-	-	880	1231	-	1031
RPA-42	-	-	-	-	856	-	-	1435	1845	1135
RPA-44	-	-	-	-	1250/A	-	-	-	-	-
RPA-47	-	-	2240	-	863/971	-	-	1640	2050	1240
RPA-48	-	-	-	-	1456/A	-	-	-	-	-
RPA-52	-	-	-	1445	-	-	-	1845	-	1445
RPA-55	-	-	-	-	-	-	-	-	-	-
RPA-60	-	-	-	1650	-	-	-	2050	-	1650
RPA-65	-	-	-	-	1663/A	-	-	-	-	-
RPA-66	-	-	-	1856	-	-	-	-	-	1856
RPA-73	-	-	-	-	-1671/A-2071/A	-	-	2563	-	2063
RPA-81	-	-	-	-	2080/A	-	-	-	-	2271
RPA-88	-	-	-	-	-	-	-	-	-	2380
RPA-90	-	-	-	-	-	-	-	-	-	2590
RPA-100	-	-	-	-	-	-	-	-	-	28100



PV Inlet hood for use with the HEPT, HCT, HGT and HTP series

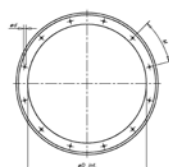

Model	øA	øB	øD	ød	E	M	H
PV-315	398	355	320	10	1,5	8x45°	165
PV-355	438	395	359	10	1,5	8x45°	165
PV-400	484	450	401	12	1,5	8x45°	165
PV-450	534	500	450	12	1,5	8x45°	165
PV-500	584	560	504	12	1,5	12x30°	165
PV-560	664	620	565	12	1,5	12x30°	165
PV-630	734	690	634	12	1,5	12x30°	165
PV-710	812	770	711	12	2	16x22,5°	250

Model	øA	øB	øD	ød	E	M	H
PV-800	904	860	797	12	2	16x22,5°	250
PV-900	1004	970	894	14	2	16x22,5°	250
PV-1000	1105	1070	1003	14	2	16x22,5°	250
PV-1250	1370	1320	1240	14	2	20x18°	250
PV-1400	1533	1470	1413	15	3	20x18°	250
PV-1600	1705	1680	1585	19	3	24x15°	315
PV-1800	1908	1830	1788	19	3	24x15°	315
PV-2000	2113	2080	1993	19	3	24x15°	315



EFFICIENT WORK



BTUB

Coupling flange for axial fans.

Model	HEPT	HCT	HGT	HPX	HT*
BTUB-250	-	25	-	-	25
BTUB-280	-	31	-	-	-
BTUB-315	31	-	-	-	31
BTUB-355	35	35	-	-	35
BTUB-400	40	40	-	-	40
BTUB-450	45	45	-	45	45

Model	HEPT	HCT	HGT	HPX	HT*
BTUB-500	50	50	-	50	50
BTUB-560	56	56	-	56	56
BTUB-630	63	63	-	63	63
BTUB-710	-	71	-	71	71
BTUB-800	-	80	-	80	80
BTUB-900	-	90	-	90	90

Model	HEPT	HCT	HGT	HPX	HT*
BTUB-1000	-	100	-	100	100
BTUB-1250	-	-	125	-	-
BTUB-1400	-	-	140	-	-
BTUB-1600	-	-	160	-	-

* For installation, the PA accessory must be used



B Coupling flange for centrifugal fans.

Features:

- Adapted to inlet and outlet.
- Aids installation on duct

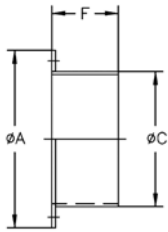

	A	C	F
B-52-E	100	52	67
B-63	110	63	60
B-80	150	80	60
B-80-E	150	80	60
B-100	150	100	60
B-100-E	170	100	60
B-112	160	112	60
B-125	180	125	60
B-140	190	140	60
B-150	210	150	60
B-160	220	160	60
B-160/1	220	160	60
B-180	240	180	60
B-200	260	200	60

	A	C	F
B-224	280	224	60
B-250/1	310	250	80
B-250/2	310	250	80
B-250/3	310	250	80
B-250/4	310	250	80
B-250/5	310	250	80
B-280/1	350	280	80
B-280/2	350	280	80
B-280/3	350	280	80
B-315/1	350	315	80
B-315/2	380	315	80
B-315/3	380	315	80
B-315/4	380	315	80
B-355/1	430	355	80

	A	C	F
B-355/2	430	355	80
B-355/3	430	355	80
B-355/4	430	355	80
B-400/1	480	400	80
B-400/2	480	400	80
B-400/3	480	400	80
B-400/4	480	400	80
B-450/1	530	450	80
B-450/2	530	450	80
B-450/3	530	450	80
B-500/1	590	500	80
B-500/2	590	500	80
B-500/3	590	500	80
B-500/4	590	500	80

	A	C	F
B-500/5	590	500	80
B-560/1	650	560	80
B-560/2	650	560	80
B-560/3	650	560	80
B-630/1	720	630	80
B-630/2	720	630	80
B-630/3	720	630	80
B-630/4	720	630	80
B-710/1	800	710	80
B-710/2	800	710	80
B-710/3	800	710	80
B-800	890	800	100
B-900/1	1000	900	100
B-1000/1	1100	1000	100

Model	CHT/CVT	CHRE
B-52-E	-	-
B-63	-	-
B-80	-	-
B-80-E	-	-
B-100	-	-
B-100-E	-	-
B-112	-	-
B-125	-	-
B-140	-	-
B-150	-	-
B-160	-	-

Model	CHT/CVT	CHRE
B-160/1	-	722
B-180	-	825
B-200	-	-
B-224	-	-
B-250/1	-	-
B-250/2	-	-
B-250/3	200/225	1131
B-250/4	-	-
B-250/5	-	-
B-280/1	-	-
B-280/2	-	-

Model	CHT/CVT	CHRE
B-280/3	-	-
B-315/1	-	-
B-315/2	-	-
B-315/3	-	-
B-315/4	-	-
B-355/1	-	-
B-355/2	-	-
B-355/3	250/315	1135/1240
B-355/4	-	-
B-400/1	-	-
B-400/2	-	-

Model	CHT/CVT	CHRE
B-400/3	-	-
B-400/4	-	-
B-450/1	-	-
B-450/2	-	-
B-450/3	-	-
B-500/1	-	-
B-500/2	-	-
B-500/3	-	-
B-500/4	400/450	1445/1650
B-560/1	-	-
B-560/2	-	-

Model	CHT/CVT	CHRE
B-560/3	-	-
B-630/1	-	-
B-630/2	-	-
B-630/3	500	-
B-630/4	-	-
B-710/1	-	-
B-710/2	560/630	-
B-710/3	-	-
B-800	-	-
B-900/1	-	-
B-1000/1	-	-



BD Dual coupling flange for centrifugal fans

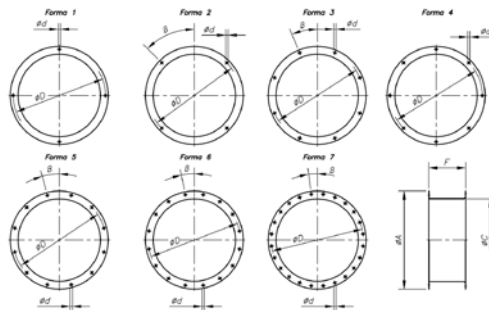

	ØA	ØC	ØD	Ød	F	β	Form
BD-200	260	200	225	7	80	15°	2
BD-224	280	224	254	7	80	-	1
BD-250/1	310	250	280	10	80	45°	2
BD-280	350	280	320	10	100	-	4
BD-315/3	390	315	355	10	100	22°30'	3
BD-355/3	430	355	395	10	100	22°30'	3
BD-400/1	480	400	450	12	100	22°30'	3
BD-400/2	480	400	450	12	100	22°30'	3
BD-450/1	530	450	500	12	100	22°30'	3
BD-450/2	530	450	500	12	100	22°30'	3
BD-500/2	590	500	560	12	100	15°	5
BD-560	650	560	620	12	120	15°	5
BD-630/2	720	630	690	12	120	15°	5
BD-710	800	710	770	12	120	11°15'	6
BD-800	890	800	860	12	140	11°15'	6
BD-900/1	1000	900	958	12	140	11°15'	6
BD-1000/1	1100	1000	1067	14	140	7°30'	7

Features:

- Adapted to the inlet
- Aids installation on duct with flange

Model	Applies to models			
	CB	CMP	CMR-X CMR	CMC
BD-112	-	512	-	-
BD-140	-	514	-	-
BD-160	-	616	-	628/630
BD-180	-	718	-	-
BD-200	820	620/820	-	835/840
BD-224	-	922	-	-
BD-250/1	-	1025	-	-
BD-250/2	1428	-	-	-
BD-280	-	1128	-	-
BD-315/1	1733	-	-	-

Model	Applies to models			
	CB	CMP	CMR-X CMR	CMC
BD-315/2	-	-	1031	-
BD-315/3	-	1231	-	-
BD-355/1	-	-	1135	-
BD-355/2	2240	-	-	-
BD-355/3	-	1435	-	-
BD-400/1	-	1640	-	-
BD-400/2	-	-	1240	-
BD-450/1	-	1845	-	-
BD-450/2	-	-	1445	-
BD-500/1	-	2050	-	-

Model	Applies to models			
	CB	CMP	CMR-X CMR	CMC
BD-500/2	-	-	1650	-
BD-560	-	-	1856	-
BD-630/1	-	2563	-	-
BD-630/2	-	-	2063	-
BD-710	-	-	2271	-
BD-800	-	-	2380	-
BD-900/1	-	-	2590	-
BD-1000/1	-	-	28100	-



BAC Double, elastic coupling flange for axial fans

Features:

- Adapted to inlet and outlet
- Aids installation on duct with flange
- Prevents transmission of vibrations

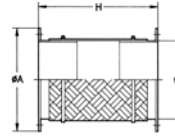

	ØD*	ØA*	H
BAC-250	250	310	340
BAC-355	355	430	340
BAC-400	400	480	340
BAC-450	450	530	340
BAC-500	500	590	340
BAC-560	560	650	340
BAC-630	630	720	340
BAC-710	710	800	340
BAC-800	800	890	340
BAC-900	900	1000	340
BAC-1000	1000	1100	340
BAC-1250	1250	1365	340

*Nominal diameter for pipe.

Model	HEPT	HCT	HGT	CHT	HT	HPX	CHRE
BAC-160	-	-	-	-	-	-	722
BAC-180	-	-	-	-	-	-	825
BAC-250	-	25	-200/225	25	-	-	1131
BAC-315/B	-	31	-	-	-	-	-
BAC-315	31	-	-	-	31	-	-
BAC-355	35	35	-250/315	35	-	351135/1240	-
BAC-400	40	40	-	-	40	-	-
BAC-450	45	45	-	-	45	45	-

Model	HEPT	HCT	HGT	CHT	HT	HPX	CHRE
BAC-500	50	50	-400/450	50	-	50 1145/1650	-
BAC-560	56	56	-	-	56	56	-
BAC-630	63	63	-	500	63	63	-
BAC-710	-	71	-560/630	71	71	-	-
BAC-800	-	80	-	-	80	80	-
BAC-900	-	90	-	-	90	90	-
BAC-1000	-	100	-	-	100	100	-
BAC-1250	-	-	125	-	-	-	-



PS Support stands for long-cased fans.

Features:

- When fixed to the flange, it allows the fan to be fixed to flat surfaces.

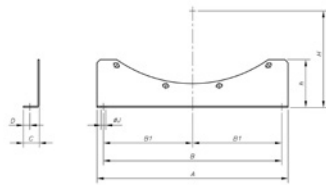

	A	B	B1	C	D	h	H	ØJ	HEPT	HCT	HGT	HPX
PS-25/31	275	225	-	25	10.5	90	165	10	-	25	-	-
	275	225	-	25	10.5	90	191.5	10	-	31	-	-
	275	225	-	25	10.5	90	205	10	31	-	-	-
PS-35/40	240	200	-	30	13	60	230	10	35	35	-	35
	240	200	-	30	13	60	255.5	10	40	40	-	-
PS-45/50	450	400	200	35	14.5	125	278	12	45	45	-	45
	450	400	200	35	14.5	125	305	12	50	50	-	50
PS-56/63	520	430	215	40	17	155	338	13	56	56	-	56
	520	430	215	40	17	155	385.5	13	63	63	-	63
PS-71	490	450	225	50	21	150	445	13	-	71	-	71
PS-80	600	560	280	50	21	150	490	13	-	80	-	80
PS-90	620	560	280	60	28	175	547.5	18	-	90	-	90
PS-100	680	560	280	60	28	185	597.5	18	-	100	-	100
PS-125	1000	900	300	60	28	285	726.5	18	-	-	125	-



PSB Set of support stand for low-pressure centrifugal fans

Features:

- Two-part set to allow fixing to flat surfaces

Model	Applies to models
PSB-1428	CB-1428
PSB-1733	CB-1733
PSB-19	CBD-1919, CBX-1919

Model	Applies to models
PSB-25	CBD-2520, CBD-2525, CBX-2525
PSB-28	CBD-2821, CBD-2828, CBX-2828
PSB-33	CBD-3325, CBD-3333, CBX-3333

Model	Applies to models
PSB-39	CBD-3939, CBX-3939
PSB-47	CBX-4747



MS Support frame to facilitate mounting on-site.

Features:

- Used to facilitate on-site mounting of fans in ducts.

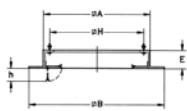

	ØA	ØB	E	ØH	h
MS-348	348	520	60	295	70
MS-393	393	565	60	320	70
MS-443	443	615	60	360	70
MS-493	493	665	60	410	70
MS-553	553	725	60	450	70

	ØA	ØB	E	ØH	h
MS-623	623	795	60	530	70
MS-701	701	875	60	590	90
MS-791	791	965	60	680	90
MS-891	891	1065	60	750	90
MS-991	991	1165	60	850	90
MS-1086	1086	1260	60	900	90
MS-1140	1140	1314	60	1000	90
MS-1240	1240	1414	60	1100	90

Model	CHT	HT	CHRE
MS-348	-	-	722
MS-393	-	-	825
MS-443	200/225	25	1131
MS-493	-	31	-
MS-553	250/315	35	1135/1240
MS-623	-	40	-
MS-701	400/450	45	1445/1650
MS-791	-	50	-
MS-891	500	56	-
MS-991	-	63/71	-
MS-1086	560/630	-	-
MS-1140	-	80/90	-
MS-1240	-	100	-



TEJ Outside covers.

Features:

- Avoids water entering ventilation units installed outside.

Applies to models

	A	B	E	CJMP	CJTCR/R	CJS
TEJ-820	500	550	26	820	-	-
TEJ-922	710	710	26	922	-	-
TEJ-1025	760	760	26	1025	-	-
TEJ-1128	820	820	26	1128	-	-
TEJ-1231	900	900	26	1231	-	1240/1850
TEJ-1435	980	980	26	1435	-	-

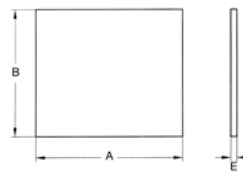

Applies to models

	A	B	E	CJMP	CJTCR/R	CJS
TEJ-1640	1071	1070	26	1640	1240	2056/2263-6T
TEJ-1845	1170	1170	26	1845	1445	2263-4T/2071/2280
TEJ-1856	1360	1150	26	-	1856	-
TEJ-2050	1260	1260	26	2050	1650	-
TEJ-2063	1500	1300	26	-	2063	-
TEJ-2271	1655	1455	26	-	2271	-



EFFICIENT WORK

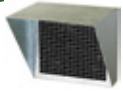

VIS Outlet hood with protection guard.

Features:

- Prevents objects and water from entering the fan.

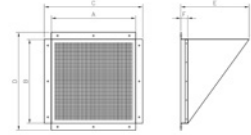

	A	B	C	D	E	F	CJTX-C	
VIS-7/7	269	246	309	286	200	50	7/7	
VIS-9/9	335	300	375	340	200	50	9/9	
VIS-10/10	364	326	404	366	250	50	10/10	
VIS-12/12	425	380	465	420	250	50	12/12	
VIS-15/15	513	441	573	501	300	50	15/15	
VIS-18/18	582	510	642	570	350	50	18/18	
VIS-20/20	641	641	741	741	400	50	20/20	
VIS-22/22	695	735	795	835	450	50	22/22	
VIS-25/25	805	836	905	936	500	50	25/25	
VIS-30/28	930	972	1030	1072	600	50	30/28	
	A	B	C	D	E	F	CJBDT	
VIS-CJBDT-9/9	310	270	-	-	200	80	9/9	
VIS-CJBDT-10/10	336	298	-	-	200	80	10/10	
VIS-CJBDT-12/12	397	351	-	-	300	80	12/12	
VIS-CJBDT-15/15	480	414	-	-	300	80	15/15	
VIS-CJBDT-18/18	552	493	-	-	300	80	18/18	
VIS-CJBDT-20/20	612	615	-	-	500	80	20/20	
VIS-CJBDT-22/22	666	706	-	-	500	80	22/22	
	A	B	C	D	E	F	CJMP	CJTCR/R
VIS-820	132	157	-	-	170	56.5	820	-
VIS-922	142	216	-	-	215	56.5	922	-
VIS-1025	167	251	-	-	240	56.5	1025	-
VIS-1128	182	296	-	-	270	56.5	1128	-

	A	B	C	D	E	F	CJLINE	CJS
VIS-1231	202	321	-	-	290	56.5	1231	-
VIS-1240	317	401	-	-	350	56.5	-	1240
VIS-1435	232	281	-	-	260	56.5	1435	-
VIS-1445	357	451	-	-	385	56.5	-	1445
VIS-1640	252	321	-	-	290	56.5	1640	-
VIS-650	402	501	-	-	420	56.5	-	1650
VIS-1845	286	361	-	-	320	56.5	1845	-
VIS-1856	452	561	-	-	-	-	-	1856
VIS-2050	317	451	-	-	385	56.5	2050	-
VIS-2063	502	631	-	-	515	56.5	-	2063
VIS-2271	562	716	-	-	575	56.5	-	2271
	A	B	C	D	E	F	CJLINE	CJS
VIS-1131	560	450	-	-	250	100	1131	-
VIS-1235	620	500	-	-	250	100	1235	-
VIS-1640/E	710	560	-	-	250	100	1640	-
VIS-1845/E	800	630	-	-	250	100	1845/1650/H	-
VIS-1856/E	1000	800	-	-	250	100	1856	-1856/H
VIS-2063/E	1120	900	-	-	250	100	2063	-2063/H
VIS-2271/E	1190	900	-	-	250	100	2271	-2271/H
VIS-2880	1250	1000	-	-	250	100	2880	-
VIS-100	600	600	698	698	485	-	-	1240/1850
VIS-200	725	725	823	823	576	-	-	2056/2263-6T
VIS-300	800	800	898	898	630	-	-	2263-4T/2071-6T-3
VIS-400	860	860	958	958	674	-	-	2071-4T/6T-5.5/2880



PA Adaptation plate to mount accessories on roof fans

Features:

- Used to mount PT, B, BTUB, BAC accessories.
Allows fan to be separated from its base without dismantling accessories.

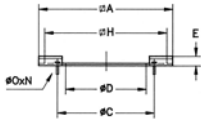

	∅A	∅C	∅D	E	∅H	∅O	N
PA-345	345	200	165	20	245	M.8	4x90°
PA-390	390	210	190	20	320	M.8	4x90°
PA-440/250	440	280	249	20	360	M.6	4x90°
PA-490	490	355	314	20	410	M.8	8x45°
PA-550	550	395	354	20	450	M.6	8x45°
PA-620	620	450	399	20	530	M.10	8x45°
PA-700/500	700	560	499	20	590	M.10	12x30°
PA-700/450	700	500	449	20	590	M.10	8x45°
PA-790	790	560	499	20	680	M.10	12x30°

	∅A	∅C	∅D	E	∅H	∅O	N
PA-890/630	890	690	629	20	750	M.10	12x30°
PA-890/560	890	620	559	20	750	M.10	12x30°
PA-990/630	990	690	629	20	850	M.10	12x30°
PA-990/710	990	770	709	20	850	M.10	16x22°30'
PA-1085	1088	770	704.5	20	900	M.10	16x22°30'
PA-1138/800	1138	860	799	25	1000	M.10	16x22°30'
PA-1138/900	1138	970	899	25	1000	M.12	16x22°30'
PA-1238	1238	1070	999	25	1100	M.12	16x22°30'

Model	CHT	HT	CHRE
PA-345	-	-	722
PA-390	-	-	825
PA-440/250	200/225	25	1131
PA-490	-	31	-
PA-550	250/315	35	1135/1240
PA-620	-	40	-
PA-700/500	400/450	-	1445/1650
PA-700/450	-	45	-
PA-790	-	50	-
PA-890/630	500	-	-
PA-890/560	-	56	-
PA-990/630	-	63	-
PA-990/710	-	71	-
PA-1085	560/630	-	-
PA-1138/800	-	80	-
PA-1138/900	-	90	-
PA-1238	-	100	-



BS BSS

High base plate and high base plate with silencer

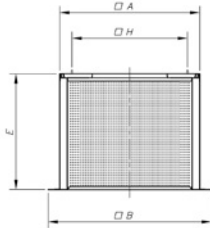

Model	A	B	H	E	CHT/CVT	HT	CHRE
BS BSS - 348	348	520	295	800	-	-	722
BS BSS - 393	393	565	320	800	-	-	825
BS BSS - 443	449	616	360	800	200/225	25	1131
BS BSS - 493	493	665	410	800	-	31	-
BS BSS - 553	554	724	450	800	250/315	35	1135/1240
BS BSS - 623	623	795	530	800	-	40	-
BS BSS - 701	706	876	590	900	400/450	45	1445-1650
BS BSS - 791	791	965	680	900	-	50	-
BS BSS - 891	896	1076	750	900	500	56	-
BS BSS - 991	991	1165	850	900	-	63/71	-
BS BSS - 1086	1092	1272	900	900	560/630	-	-
BS BSS - 1140	1140	1314	1000	900	-	80/90	-
BS BSS - 1240	1240	1414	1100	900	-	100	-

PT

Automatic-closing shutters to work in vertical and horizontal position version 400, certified for 400°C/2h

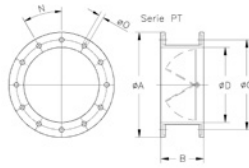

	ØA	B	ØC	ØD*	ØO	N	CHT/CVT	CHRE
PT-160	220	150	200	160	10	4x90°		722
PT-180	240	150	210	180	10	4x90°		825
PT-250	310	150	280	250	10	4x90°	200/225	1131
PT-355	435	200	395	355	10	8x45°	250/315	1135/1240
PT-500	600	280	560	500	12	12x30°	400/450	1445/1650
PT-630	730	355	690	630	12	12x30°		500
PT-710	810	400	770	710	12	16x22°30'	560/630	

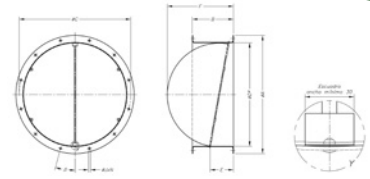
PT/H

	ØA	B	ØC	ØD*	E	F	ØJ	ØK	ØL	ØM	ØN
PT-450/H	540	254	500	460	185	340	22° 30'	12			8x45°
PT-500/H	600	254	560	514	185	346	15°	12			12x30°
PT-560/H	660	254	620	560	185	363	15°	12			12x30°
PT-630/H	730	254	690	640	185	409	15°	12			12x30°
PT-710/H	810	254	770	710	185	443	11°15'	12			16x22°30'
PT-800/H	900	254	860	800	185	488	11°15'	12			16x22°30'
PT-900/H	1015	254	970	900	185	555	11°15'	15			16x22°30'
PT-1000/H	1115	254	1070	1000	185	609	11°15'	15			16x22°30'
PT-1250/H	1365	254	1320	1250	185	736,5	9°	15			20x18°

BIC

Flange conversion from rectangular to circular for centrifugal fans.

Features:

- Adapted to the outlet
- Aids installation on circular duct

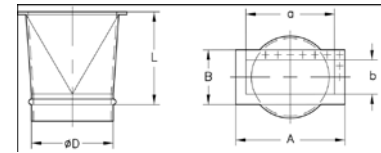

Model	L	D	a	b	A	B	Applies to models
BIC-820-CB	300	200	160	130	213	184	CB-820
BIC-1428	300	250	286	202	350	260	CB-1428
BIC-1733	300	280	339	240	415	315	CB-1733
BIC-2240	450	355	400	300	478	372	CB-2240
BIC-628	200	150	86	86	130	130	CMC-628
BIC-630	200	150	86	86	130	130	CMC-630
BIC-835	200	200	91	91	141	141	CMC-835
BIC-840	200	200	91	91	141	141	CMC-840
BIC-242	200	100	95	60	155	120	CAS/CAST-242
BIC-248	200	112	105	66	165	126	CAS/CAST-248
BIC-254	200	125	115	75	175	135	CAS/CAST-254
BIC-260	200	150	125	85	185	145	CAS/CAST-260
BIC-463	200	200	125	85	185	145	CAS/CAST-463
BIC-467	250	224	130	90	190	150	CAS/CAST-467
BIC-571	250	250	145	95	205	155	CAS/CAST-571
BIC-640	250	250	200	125	260	185	CAS/CAST-640
BIC-645	250	250	224	140	284	200	CAS/CAST-645
BIC-650	250	250	250	160	310	220	CAS/CAST-650
BIC-680	250	180	100	71	160	131	CAS-680
BIC-790	250	180	112	80	172	140	CAS-790
BIC-852	250	280	280	180	340	240	CAS/CAST-852
BIC-856	280	355	280	180	340	240	CAS/CAST-856
BIC-863	280	355	315	200	375	260	CAS/CAST-863
BIC-971	280	400	355	224	425	294	CAS/CAST-971
BIC-980	300	250	200	140	270	210	CAS/CAST-980
BIC-990	300	280	224	160	294	230	CAS-990
BIC-1080	300	250	200	140	270	210	CAS-1080
BIC-1090	300	280	224	160	294	230	CAS-1090
BIC-1250	450	400	400	280	480	360	CAS/CAST-1250/A
BIC-1456	450	450	450	315	530	395	CAS/CAST-1456/A
BIC-1663	450	500	500	355	580	435	CAS/CAST-1663/A
BIC-1671	450	630	560	400	660	500	CAS-1671/A-2071/A
BIC-2080	450	710	630	450	730	550	CAS-2080/A
BIC-540	300	180	140	120	224	206	CAM-540
BIC-545	300	180	170	135	255	222	CAM-545
BIC-550	300	224	200	150	296	246	CAM-550
BIC-752	300	224	200	160	296	256	CAM-752
BIC-760	300	250	220	180	316	276	CAM-760
BIC-880	300	315	290	190	360	249	CAM-880
BIC-1445/E	450	450	450	355	538	445	CBP-1445
BIC-1650/E	450	500	500	400	590	490	CBP-1650
BIC-1856/E	450	560	560	450	660	550	CBP-1856

Model	L	D	a	b	A	B	Applies to models
BIC-512	300	112	86	75	118	104	CMP-512
BIC-514	300	140	107	83	147	122	CMP-514
BIC-616	300	160	125	103	172	153	CMP-616
BIC-620	300	200	100	105	153	159	CMP-620
BIC-718	300	180	146	115	192	169	CMP-718
BIC-820	300	200	156	160	213	184	CMP-820
BIC-922	300	224	216	140	282	204	CMP-922
BIC-1025	300	250	250	165	314	229	CMP-1025
BIC-1128	300	280	300	180	364	244	CMP-1128
BIC-1231	300	315	320	200	384	266	CMP-1231
BIC-1435	300	355	280	228	344	294	CMP-1435
BIC-1640	300	400	320	250	404	336	CMP-1640
BIC-1845	450	450	360	284	444	370	CMP-1845
BIC-2050	450	500	450	315	545	412	CMP-2050
BIC-2563	450	630	600	410	706	512	CMP-2563
BIC-922-T	300	180	216	140	282	204	CMT-922
BIC-1025-T	300	200	250	165	314	229	CMT-1025
BIC-1128-T	300	224	300	180	364	244	CMT-1128
BIC-1231-T	300	250	320	200	384	266	CMT-1231
BIC-1435-T	300	280	280	228	344	294	CMT-1435
BIC-1640-T	300	280	320	250	404	336	CMT-1640
BIC-1845-T	450	355	360	284	444	370	CMT-1845
BIC-2050-T	450	400	450	315	545	412	CMT-2050
BIC-622	250	152	150	120	191,5	180	CMR-622
BIC-625	250	165	167,5	125	207,5	185	CMR-625
BIC-728	250	185	187,5	136,5	234,5	196,5	CMR-728
BIC-731	250	200	211	130,5	250,5	190,5	CMR-731
BIC-1031	300	315	315	250	385	320	CMR-1031
BIC-1135	450	355	355	280	425	350	CMR-1135
BIC-1240	450	400	400	315	480	395	CMR-1240
BIC-1445	450	450	450	355	540	445	CMR-1445
BIC-1650	450	500	500	400	590	490	CMR-1650
BIC-1856	450	560	560	450	660	550	CMR-1856
BIC-2063	450	630	630	500	750	620	CMR-2063
BIC-2271	450	710	710	560	840	690	CMR-2271
BIC-2380	600	800	800	560	920	680	CMR-2380
BIC-2380/E	600	800	1120	560	1246	690	CMR-2380-X
BIC-2590	600	900	900	630	1020	750	CMR-2590
BIC-28100	600	1000	1000	710	1120	830	CMR-28100
BIC-1840	150	370	273	210	353	303	CPV-1840
BIC-2045	190	400	330	270	420	360	CPV-2045



EFFICIENT WORK



ACE

Elastic coupling to absorb vibrations

Features:

- Used between the fan inlet/outlet and the duct to avoid transmitting vibrations

Applies to models (INLET)

Applies to models (OUTLET)

CMAT	Applies to models (INLET)								Applies to models (OUTLET)											
	CMA	CB	CAS	CA	CAM	CMP	CMT	CBP	CMR-X	CMC	CMA	CAS	CA	CAM	CB	CMP	CMT	CMR-X	CMC	
ACE-52	-	-	-	-	-	-	-	-	-	-	-	-	-	-	-	-	-	-	-	-
ACE-63	-	-	-	-	-	-	-	-	-	-	218/324	-	-	-	-	-	-	-	-	-
ACE-80	218/324	-	-	-	-	-	-	-	-	-	325	-	-	148/154/160/166	-	-	-	-	-	-
ACE-100	325	-	242	234/142	-	-	-	-	-	-	426/527	242	172	-	-	-	-	-	-	-
ACE-112	426	-	248	148	-	512	-	-	-	-	-	248	-	-	-	512	-	-	-	-
ACE-125	527/528	-	254	154	-	-	-	-	-	-	528	254	-	-	-	-	-	-	-	-
ACE-140	-	-	-	-	-	514	-	-	-	-	-	-	-	-	-	514	-	-	-	-
ACE-150	531	-	260	160	-	-	-	-	-	628/630	531/540	260	-	-	-	-	-	-	-	628/630
ACE-160	-	-	680	-	-	616	-	-	-	-	-	-	-	-	-	616	-	-	-	-
ACE-180	540/545	-	790	166/172	540/545	718	922	-	-	-	545	680/790	-	540/545	-	718	922	-	-	-
ACE-200	-	820	463	-	-	620/820	1025	-	-	835/840	-	463	-	-	820	620/820	1025	-	-	835/840
ACE-224	-	-	467	-	550/752	922	1128	-	-	-	-	467	-	550/752	-	922	1128	-	-	-
ACE-250	-	1428	571/640/645 850/980/1090	-	760	1025	1231	-	-	-	-	570/640/645 850/980/1090	-	760	1428	1025	1231	-	-	-
ACE-280	-	-	852/990/1090	-	-	1128	1435/1640	-	-	-	-	852/990/1090	-	-	1733	1128	1435/1640	-	-	-
ACE-315	-	1733	-	-	880	1231	-	-	1031	-	-	-	-	880	-	1231	-	-	1031	-
ACE-355	-	2240	856/863/1250/A	-	-	1435	1845	-	1135	-	-	856/863	-	-	2240	1435	1845	-	1135	-
ACE-400	-	-	971/1456/A	-	-	1640	2050	-	1240	-	-	971/1250/A	-	-	-	1640	2050	-	1240	-
ACE-450	-	-	-	-	-	1845	-	1445	1445	-	-	1456/A	-	-	-	1845	-	1445	-	-
ACE-500	-	-	-	-	-	2050	-	1650	1650	-	-	1663/A	-	-	-	2050	-	1650	-	-
ACE-560	-	-	1663/A	-	-	-	-	-	1856	1856	-	-	-	-	-	-	-	-	1856	-
ACE-630	-	-	1671/A-2071/A	-	-	2563	-	-	2063	-	-	1671/A-2071/A	-	-	-	2563	-	-	2063	-
ACE-710	-	-	2080/A	-	-	-	-	-	2271	-	-	2080/A	-	-	-	-	-	-	2271	-
ACE-800	-	-	-	-	-	-	-	-	2380	-	-	-	-	-	-	-	-	-	2380	-
ACE-900	-	-	-	-	-	-	-	-	2590	-	-	-	-	-	-	-	-	-	2590	-
ACE-1000	-	-	-	-	-	-	-	-	28100	-	-	-	-	-	-	-	-	-	28100	-



REG

Record of manual regulation

Features:

- Their design allows them to be installed in ducting systems to adjust the airflow.

Model	L	ØD*	Model	L	ØD*
REG-80	100	80	REG-250	100	250
REG-100	100	100	REG-280	100	280
REG-112	100	112	REG-315	100	315
REG-125	100	125	REG-355	100	355
REG-140	100	140	REG-400	100	400
REG-150	100	150	REG-450	150	450
REG-160	100	160	REG-500	150	500
REG-180	100	180	REG-560	150	560
REG-200	100	200	REG-630	250	630
REG-224	100	224	REG-800	250	800



CJACUS

Soundproofed boxes for centrifugal fans

Features:

- Ventilation box in galvanised sheet steel with acoustic insulation
- Mounting feet and Silent-Blocks included
- CJACUS/C: With inlet and outlet connection outside through ducts Motor cooling grille vent included
- CJACUS/L: With free inlet through vent built into the box and outlet connection to the outside

Applies to models

Model	CAS	CA	CAM
CJACUS-0	640	154	540
CJACUS-1	254/645	160	545
CJACUS-2	260/463/650	166	550/752
CJACUS-3	467/852/856	172	-
CJACUS-4	571/863	-	760
CJACUS-5	971	-	880



OP

Backdraught shutters for roof fans

OP-25	HT-25	OP-40	HT-40	OP-56	HT-56	OP-80	HT-80
OP-31	HT-31	OP-45	HT-45	OP-63	HT-63	OP-90	HT-90
OP-35	HT-35	OP-50	HT-50	OP-71	HT-71	OP-100	HT-100



S Silencers to fit to inlet or outlet.

Features:

- Circular or rectangular silencers to fit to inlet or outlet on centrifugal or axial fans.

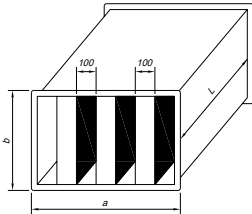

INLET / OUTLET (Rectangular cross section)

	L	a	b	Kg	Replacement dampers (dB) on octave band (Hz)						Applicable
					125	250	500	1000	2000	4000	
SR-1000/900/900	900	1000	900	64	4	10	21	37	44	37	HCH/HCT/THT-63
SR-1200/900/900	900	1200	900	74	4	10	21	37	44	37	HCH/HCT/THT-71
SR-1400/1200/900	900	1400	1200	102	4	12	25	41	47	42	HCH/HCT/THT-80
SR-1800/1200/1200	1200	1800	1200	169	4	12	25	41	47	42	HCH/HCT/THT-90
SR-1800/1500/1200	1200	1800	1504	195	4	12	25	41	47	42	HCH/HCT/THT-100

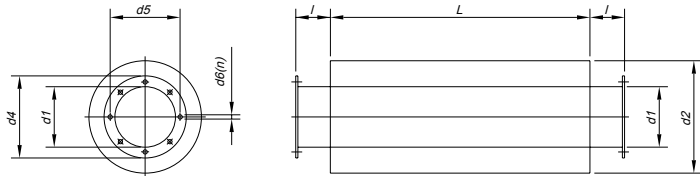

INLET / OUTLET (Circular cross section)

	L	d1	d2	l	d3	d4	d5	d6	n	Kg	Replacement dampers (dB) on octave band (Hz)						Applicable
											125	250	500	1000	2000	4000	
SC-630/900	900	630	800	100	630	720	690	12	12x30°	44	5	8	14	12	13	9	HCH/HCT/THT-63
SC-710/900	900	710	900	100	710	800	770	12	16x22°30'	65	5	8	13	11	12	8	HCH/HCT/THT-71
SC-800/900	900	800	1000	100	800	900	860	12	16x22°30'	70	4	8	11	9	9	8	HCH/HCT/THT-80
SC-900/1200	1200	900	1120	100	900	1000	970	15	16x22°30'	87	5	7	11	11	7	5	HCH/HCT/THT-90
SC-1000/1200	1200	1000	1200	100	1000	1100	1070	15	16x22°30'	95	4	7	11	10	7	6	HCH/HCT/THT-100

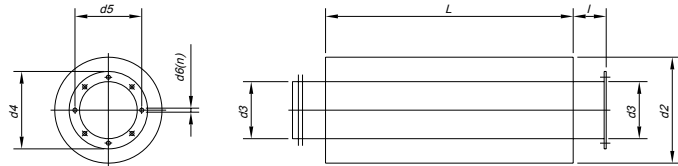

INLET

	L	d2	d3	d4	d5	d6	n	Kg	Replacement dampers (dB) on octave band (Hz)						Applicable	
									125	250	500	1000	2000	4000		
S-160/600-A	600	260	160	220	200	10	4x90°	6	3	11	22	33	42	29		CHRE-722
S-180/600-A	600	300	180	240	210	10	4x90°	7	4	8	15	31	28	20		CHRE-825
S-250/600-A	600	450	250	310	280	10	4x90°	14	5	12	20	24	23	14		CVT-CHT-200/225 HT-25 / CHRE-1131
S-315/900-A	900	500	315	390	355	10	8x45°	22	4	12	21	26	19	15		HT-31
S-355/900-A	900	560	355	430	395	10	8x45°	25	4	12	20	24	18	14		CVT-CHT-250/315 HT-35 / CHRE-1135/1240
S-400/900-A	900	600	400	480	450	12	8x45°	29	5	12	19	22	18	13		HT-40
S-450/900-A	900	630	450	530	500	12	8x45°	32	5	12	18	20	16	12		HT-45
S-500/900-A	900	710	500	590	560	12	12x30°	35	4	11	18	16	14	11		CVT-CHT-400/450 HT-50 / CHRE-1445/1650
S-560/900-A	900	750	560	650	620	12	12x30°	41	4	10	16	14	13	10		HT-56
S-630/900-A	900	800	630	720	690	12	12x30°	44	5	8	14	12	13	9		CVT-CHT-500 / HT-63
S-710/900-A	900	900	710	800	770	12	16x22°30'	65	5	8	13	11	12	8		CVT-CHT-560/630 HT-71
S-800/900-A	900	1000	800	900	860	12	16x22°30'	70	4	8	11	9	9	8		HT-80
S-900/1200-A	1200	1120	900	1000	970	12	16x22°30'	85	5	7	11	11	7	6		HT-90
S-1000/1200-A	1200	1200	1000	1100	1070	12	16x22°30'	95	4	7	11	10	7	6		HT-100



EFFICIENT WORK



Alphabetical index of references CENTRIFUGAL

CAS-L/EW	66	CMA/EW	40	HEPT/EW	17
CAS/EW	70	CMP-L/EW	45	HFT/EW	26
CBD/B/EW	34	CMP/EW	51	HT-L/EW	90
CBD/EW	34	CMR-L/EW	57	HT/EW	93
CHT/EW	86	CMR/EW	60	NEOLINEO/EW	13
CJBD/EW	36	CVT/EW	86	OVERPRESSURE KIT	96
CJBD/EW/AL	36	HC/EW	22	SV/ECO	11
CJEC/EW	83	HCH/EW	26	TCR/R/EW	76
CJLINE/EW	80	HCT/EW	26		
CJTCR/R/EW	76	HEP/EW	15		



Alphabetical index of references ACCESSORIES

ACE	114	OP	114	SI-CO2	103
AET	108	P	108	SI-FUENTE DE ALIMENTACIÓN	103
B	110	PA	112	SI-HUMEDAD	104
BAC	111	PL	108	SI-PIR	103
BD	110	PS	111	SI-PRESIÓN	104
BIC	113	PSB	111	SI-SMOKE	103
BOXPRES KIT	105	PT	113	SI-TEMP	104
BOXPRES KIT/B	105	PT/H	113	SI-TEMP+HUMEDAD	103
BS	112	PV	109	SI-TIMER	104
BSS	112	R	108	TEJ	111
BTUB	110	REG	114	VIS	112
CJACUS	114	RI	109	VSD1/A-RFM	102
INT	108	RPA	109	VSD1/B	102
KIT CAUDAL CONSTANTE	104	RT	109	VSD3/A-RFT	102
MS	111	S	115	VSD3/B	102
MTP010	103	SI CONTROL PRESIÓN	104		

QUICKFAN
SODECA // SELECTOR

NEW
SELECTION
SOFTWARE



Our **new tool** designed for a quick selection of the most suitable product for your ventilation project.

QUICKFAN

SODECA // SELECTOR



EASY
SEARCH



CUSTOMIZABLE
REPORTS



ALWAYS
UPDATED



SODECA



Ctra. de Berga, km 0,7
 E-08580 SANT QUIRZE DE BESORA
 (Barcelona - Spain)
 Tel. +34 93 852 91 11
 Fax +34 93 852 90 42
 comercial@sodeca.com
 Export sales: ventilation@sodeca.com
 www.sodeca.com



SODECA Group

SODECA EXPORT
 Ctra. de Berga, km 0,7
 E-08580 SANT QUIRZE
 DE BESORA
 Barcelona - SPAIN
 Tel. +34 93 852 91 11
 Fax +34 93 852 90 42
 ventilation@sodeca.com

**SODECA-PORTUGAL
 DECIFLEX**
 Mr. Luiz Araújo
 Rua Veloso Salgado 1120/1138
 4450-801 Leça de Palmeira
 Tel. +351 229 991 100
 Fax. +351 229 991 119
 geral@deciflex.com

**SODECA AMERICA
 USA - CANADA - MEXICO
 SOUTH AMERICA**
 Mr. Francesc Bertran
 Sodeca Ventiladores Ltda
 Avda. Puerta Sur 03380
 San Bernardo, SANTIAGO, CHILE
 ventas.chile@sodeca.com
 Tel. +56 (02) 2840 5582

SODECA CARIBBEAN AREA
 Mr. Carlos A. Hernández Gil
 Residencial Miramar N° 120B-7ma
 Ave. N° 1805 entre 18 y 20.
 Miramar Playa, CIUDAD DE LA
 HABANA, CUBA
 Tel. 00537 20 43721
 sodeca@enet.cu



Ctra. de Berga, km 0,7
E-08580 SANT QUIRZE DE BESORA
(Barcelona - Spain)
Tel. +34 93 852 91 11
Fax +34 93 852 90 42
comercial@sodeca.com
Export sales: ventilation@sodeca.com

www.sodeca.com



ISO 9001
BUREAU VERITAS
Certification

